

DUALITY AND TRACES FOR INDEXED MONOIDAL CATEGORIES

KATE PONTO AND MICHAEL SHULMAN

ABSTRACT. By the Lefschetz fixed point theorem, if an endomorphism of a topological space is fixed-point-free, then its Lefschetz number vanishes. This necessary condition is not usually sufficient, however; for that we need a refinement of the Lefschetz number called the Reidemeister trace. Abstractly, the Lefschetz number is a trace in a symmetric monoidal category, while the Reidemeister trace is a trace in a bicategory; in this paper we relate these contexts using indexed symmetric monoidal categories.

In particular, we will show that for any symmetric monoidal category with an associated indexed symmetric monoidal category, there is an associated bicategory which produces refinements of trace analogous to the Reidemeister trace. This bicategory also produces a new notion of trace for parametrized spaces with dualizable fibers, which refines the obvious “fiberwise” traces by incorporating the action of the fundamental group of the base space. We also advance the basic theory of indexed monoidal categories, including introducing a string diagram calculus which makes calculations much more tractable. This abstract framework lays the foundation for generalizations of these ideas to other contexts.

Contents

1	Introduction	583
2	Indexed monoidal categories	586
3	Indexed coproducts	590
4	Symmetric monoidal traces	594
5	Shadows from indexed monoidal categories	598
6	Fiberwise duality	605
7	Base change objects	611
8	Total duality	614
9	String diagrams for objects	626
10	String diagrams for morphisms	631
11	Proofs for fiberwise duality and trace	635
12	Proofs for total duality and trace	650

Both authors were supported by National Science Foundation postdoctoral fellowships during the writing of this paper. This version of this paper contains diagrams that use color to distinguish different features. An alternative version which uses dots and dashes for this purpose, and intended for printing on a black and white printer, is available from the journal web site.

Received by the editors 2011-10-31 and, in revised form, 2012-10-23.

Transmitted by Richard Blute. Published on 2012-11-05.

2010 Mathematics Subject Classification: 18D10,18D30.

Key words and phrases: duality, trace, monoidal category, indexed category, fiberwise duality.

© Kate Ponto and Michael Shulman, 2012. Permission to copy for private use granted.

1. Introduction

It is well-known that in any symmetric monoidal category, there are useful intrinsic notions of *duality* and *trace*; see, for example, [8, 17, 18]. One of the original motivating examples is that traces in the stable homotopy category compute fixed-point indices, an observation which leads directly to the Lefschetz fixed point theorem. The search for generalizations and converses of the Lefschetz fixed point theorem has led to various generalizations and refinements of the fixed-point index, such as the Reidemeister trace [4, 12]. In this paper we present an abstract framework for constructing refinements of traces in symmetric monoidal categories, which produces the Reidemeister trace as a particular example. Other examples, which we will not discuss here, include equivariant [25], relative [28], and fiberwise [27] generalizations of the Lefschetz number and Reidemeister trace.

These refinements arise from generalizations of duality and trace to *indexed* symmetric monoidal categories. An indexed symmetric monoidal category is a family of symmetric monoidal categories \mathcal{C}^A , one for each object A of a cartesian monoidal base category \mathbf{S} , equipped with base change functors induced by the morphisms of \mathbf{S} . The simplest case is when \mathbf{S} is the category of sets and \mathcal{C}^A the category of A -indexed families of objects of some fixed symmetric monoidal category, such as abelian groups or chain complexes. We can also allow \mathbf{S} to consist of groupoids or higher groupoids. The prototypical example in homotopy theory, which will give rise to the Reidemeister trace, is when \mathbf{S} is the category of topological spaces and \mathcal{C}^A is the homotopy category of parametrized spectra over A , as in [22]. More generally, \mathbf{S} could be any category of spaces, or of schemes, or a topos, and \mathcal{C}^A a category of sheaves of abelian groups, modules, spaces, or parametrized spectra on A , or a derived category thereof.

In any such context we can, of course, consider duality and trace in the individual symmetric monoidal categories \mathcal{C}^A . Following [22] we call these notions *fiberwise*, since in examples they are usually equivalent to duality and trace acting on each fiber or stalk separately. Thus, if M is fiberwise dualizable, any endomorphism $f: M \rightarrow M$ has a fiberwise trace, which is an endomorphism of the unit object I_A of \mathcal{C}^A . In examples, this trace essentially calculates the ordinary traces of the induced endomorphisms $f_x: M_x \rightarrow M_x$ of the fibers M_x , for all $x \in A$. Our first theorem gives a refinement of this fiberwise symmetric monoidal trace.

1.1. THEOREM. *If $M \in \mathcal{C}^A$ is fiberwise dualizable and $f: M \rightarrow M$ is any endomorphism, then the symmetric monoidal trace of f factors as a composite*

$$I_A \longrightarrow (\pi_A)^*\langle\langle A \rangle\rangle \xrightarrow{\text{tr}(\widehat{f})} I_A.$$

(In fact, we prove a stronger theorem about “partial traces” whose domains and codomains are “twisted” by an additional object.)

The first morphism in this factorization is defined purely in terms of A , while the second morphism contains the information about M and f . Thus, this theorem refines

$\mathrm{tr}(f)$ by lifting its domain to a potentially larger one. In examples, the refined trace $\mathrm{tr}(\widehat{f})$ also includes the traces of the composites of the fiberwise endomorphisms f_x with the action of “loops” in A on the fibers of M (in cases where A is something which contains loops, like a groupoid or a topological space).

Often, however, we are in a somewhat different situation: we want to extract trace-like information (such as fixed point invariants) from an endomorphism $f: A \rightarrow A$ in some *cartesian* monoidal category \mathbf{S} , such as sets, groupoids, or spaces. Since there are no nontrivial dualities in a cartesian monoidal category, the standard approach is to choose a non-cartesian monoidal category \mathbf{C} (such as abelian groups, chain complexes, or spectra), apply a functor $\Sigma: \mathbf{S} \rightarrow \mathbf{C}$ (such as the free abelian group or suspension spectrum), and then consider the symmetric monoidal trace of $\Sigma(f)$ in \mathbf{C} . The trace obtained from the free abelian group functor in this way simply counts the number of fixed points of a set-endofunction, while that obtained from the suspension spectrum functor is exactly the classical fixed-point index.

Now, it turns out that in most examples where this is done, there is actually an indexed symmetric monoidal category over \mathbf{S} , such that $\mathbf{C} = \mathcal{C}^*$ is the category indexed by the terminal object of \mathbf{S} . Moreover, the functor $\Sigma: \mathbf{S} \rightarrow \mathcal{C}^*$ is definable in terms of this structure: $\Sigma(A)$ is the “pushforward” to \mathcal{C}^* of the unit object of \mathcal{C}^A . For example, the free abelian group functor arises from “set-indexed families of abelian groups”, and the suspension spectrum functor arises from spectra parametrized over spaces.

Our second theorem gives a refinement of the trace of $\Sigma(f)$ in this situation. We need a slightly stronger hypothesis, however: rather than requiring $\Sigma(A)$ to be dualizable in \mathcal{C}^* (the requirement in order for $\Sigma(f)$ to have a trace), we need to assume that I_A is *totally dualizable* in \mathcal{C}^A . Total duality is a new type of duality, not reducible to symmetric monoidal duality, which can be defined in any good indexed symmetric monoidal category; it was first noticed in the case of parametrized spectra by Costenoble and Waner [5], and studied further in [22]. Total dualizability of I_A implies ordinary dualizability of $\Sigma(A)$ in \mathcal{C}^* , and in examples it seems to be not much stronger than this (if at all).

1.2. THEOREM. *If I_A is totally dualizable and $f: A \rightarrow A$ is an endomorphism in \mathbf{S} , then the symmetric monoidal trace of $\Sigma(f)$ factors as a composite*

$$I_\star \xrightarrow{\mathrm{tr}(\tilde{f})} \langle\langle A_f \rangle\rangle \longrightarrow I_\star.$$

Here, it is the *first* morphism in the factorization which should be regarded as a refined trace of f , while the second morphism forgets the additional information contained therein (although in this case, the intermediate object $\langle\langle A_f \rangle\rangle$ also depends on f). In examples, the object $\langle\langle A_f \rangle\rangle$ is “generated by” the “fixed-point classes” of f , and the refined trace $\mathrm{tr}(\tilde{f})$ separates out the contributions to the fixed-point index of f depending on which fixed-point class they belong to. In particular, in the case of spectra parametrized over spaces, we obtain the Reidemeister trace, and Theorem 1.2 says that the Reidemeister trace refines the fixed-point index.

As with Theorem 1.1, Theorem 1.2 is a special case of a stronger theorem about “partial traces” and arbitrary totally dualizable objects. We can also exploit this generalization to describe a further connection to the classical symmetric monoidal theory. Perhaps the most important “partial” or “twisted” trace is the trace of the composite

$$\Sigma(A) \xrightarrow{\Sigma(f)} \Sigma(A) \xrightarrow{\Sigma(\Delta_A)} \Sigma(A) \otimes \Sigma(A)$$

which is a map $I_\star \rightarrow \Sigma(A)$ called the **transfer of f** (or the “trace of f with respect to Δ ”). The transfer of f is also a refinement of $\text{tr}(\Sigma(f))$, in that when composed with the augmentation

$$\Sigma(\pi_A): \Sigma(A) \rightarrow \Sigma(\star) = I_\star$$

it reproduces the symmetric monoidal trace of f . The generalized version of Theorem 1.2 then implies that $\text{tr}(\tilde{f})$ refines not only $\text{tr}(\Sigma(f))$, but also the trace of f with respect to Δ .

1.3. THEOREM. *In the situation of Theorem 1.2, the transfer of f factors as a composite*

$$I_\star \xrightarrow{\text{tr}(\tilde{f})} \langle\langle A_f \rangle\rangle \rightarrow \Sigma(A).$$

Although they may seem different on the surface, Theorems 1.1 and 1.2–1.3 actually apply in *formally dual* situations (although their conclusions and proofs are not dual). This observation is originally due to May and Sigurdsson [22], who constructed a *bicategory* out of parametrized spectra, and identified fiberwise and Costenoble-Waner duality as cases of the general notion of duality in this bicategory (which comes in dual flavors, since composition in a bicategory is not symmetric). In [33], the second author generalized their construction to any indexed symmetric monoidal category. Part of proving the above theorems, therefore, will be to extend the results of [22] on duality to the case of a general indexed symmetric monoidal category.

The consideration of *traces* for bicategorical duality, on the other hand, requires an additional structure called a *shadow*, introduced by the first author in [27] and studied further in [29]. Thus, another necessary preliminary will be to prove that the bicategory arising from any indexed symmetric monoidal category has a canonical shadow. This done, we will be able to identify the morphisms $\text{tr}(\hat{f})$ and $\text{tr}(\tilde{f})$ as traces relative to the bicategorical incarnations of fiberwise and total duality, respectively, and deduce Theorems 1.1, 1.2, and 1.3.

Finally, there is one further ingredient in this paper: the use of a *string diagram* calculus for indexed monoidal categories. In general, string diagram calculus is a “Poincaré dual” way of drawing composition in categorical structures, which tends to make complicated computations much more visually evident. In particular, many basic equalities, such as the naturality of tensor products, are realized by simple isotopies. String diagrams for monoidal categories and bicategories are described in [14–17, 24, 31, 36], and a generalization for bicategories with shadows was given in [29].

Several of the results of this paper require fairly involved computations which are made much more tractable by an appropriate string diagram calculus. However, for clarity of exposition, we postpone the introduction of string diagrams (along with the proofs which depend on them, of course) to the very end of the paper. Thus, the reader can avoid string diagrams altogether by stopping after §8.

The organization of this paper is as follows. In §§2–3 we introduce indexed symmetric monoidal categories. Then in §4 we recall the classical notion of trace in symmetric monoidal categories, and construct the functor Σ referred to above. In §5 we describe the construction of a bicategory with a shadow from an indexed symmetric monoidal category.

In §6 we state the “fiberwise” duality and trace theorems—Theorem 1.1 and its generalizations—although the proofs are postponed until §11. Next, §7 is devoted to the consideration of “base change objects”, an additional bit of structure that exists in bicategories arising from indexed monoidal categories. This is then used in §8, where we state and prove the “total” duality and trace theorems, 1.2 and 1.3 and their generalizations. The proofs in this case are actually easier than the fiberwise case, although some calculations still have to be postponed to §12.

Finally, in §§9–10 we introduce our string diagram calculus, and in §§11–12 we apply it to the postponed calculations.

Throughout the paper, we make use of three primary examples:

- (i) $\mathbf{S} = \text{sets}$, $\mathcal{C}^A = A$ -indexed families of abelian groups.
- (ii) $\mathbf{S} = \text{topological spaces}$, $\mathcal{C}^A = \text{spectra parametrized over } A$.
- (iii) $\mathbf{S} = \text{groupoids}$, $\mathcal{C}^A = A$ -indexed diagrams of chain complexes.

The first is a “toy” example, which is easy to compute with, but which is so degenerate that it fails to display all of the interesting phenomena. The second is the motivating example which matters most in applications (together with various generalizations), but it is technically fairly complicated, so we omit all proofs relating to it; many of them can be found in [26]. (In particular, no knowledge of spectra is necessary to read this paper.) The third is an intermediate example which is easier to understand, but which still displays most of the interesting phenomena.

We would like to thank David Corfield, Todd Trimble, and Daniel Sch appi for helpful suggestions about string diagrams and monoidal bicategories. The second-named author gratefully acknowledges the hospitality of the University of Kentucky.

2. Indexed monoidal categories

We begin with the following standard definition (cf. for instance [23] or [13, B1.2]).

2.1. DEFINITION. Let \mathbf{S} be a category. An **\mathbf{S} -indexed category** \mathcal{C} is a pseudofunctor from \mathbf{S}^{op} to $\mathcal{C}at$.

In elementary terms, this means we have a category for each object $A \in \mathbf{S}$, which we write as \mathcal{C}^A , and a functor for each morphism $f: A \rightarrow B$ in \mathbf{S} , which we write as $f^*: \mathcal{C}^B \rightarrow \mathcal{C}^A$, such that composition and identities are preserved up to coherent natural isomorphism. We sometimes refer to \mathbf{S} as the *base category* and the \mathcal{C}^A as the *fiber categories*, and we refer to the functors f^* as *reindexing functors*.

2.2. **EXAMPLE.** If $\mathbf{S} = \mathbf{Ring}$ is the category of rings, there is an \mathbf{S} -indexed category sending a ring A to \mathbf{Mod}_A , with f^* given by restriction of scalars. There are similar examples using chain complexes, DGAs, or ring spectra.

2.3. **EXAMPLE.** For any category \mathbf{C} , there is a \mathbf{Set} -indexed category sending each set A to the category \mathbf{C}^A of A -indexed families of objects of \mathbf{C} .

2.4. **EXAMPLE.** If \mathbf{S} has finite limits, then there is an \mathbf{S} -indexed category sending each object A to its slice category \mathbf{S}/A , with the functors f^* given by pullback.

In the important special case when \mathbf{S} is the category \mathbf{Top} of topological spaces, we also have a “homotopy” version $A \mapsto \mathbf{Ho}(\mathbf{Top}/A)$, in which we invert the weak homotopy equivalences in each fiber category. See [22] for an extensive formal development of this example. Similar examples can be constructed whenever \mathbf{S} has a “homotopy theory” (e.g. when it is a Quillen model category).

“Derived” examples such as the last one are of particular interest to us. Here are two more such examples.

2.5. **EXAMPLE.** If \mathbf{Top} denotes a suitably nice category of topological spaces, there is a \mathbf{Top} -indexed category defined by $A \mapsto \mathbf{Sp}_A$, where \mathbf{Sp}_A denotes a point-set-level category of spectra parametrized over A , such as the parametrized orthogonal spectra used in [22]. We can similarly invert the weak equivalences of spectra to obtain a derived \mathbf{Top} -indexed category $A \mapsto \mathbf{Ho}(\mathbf{Sp}_A)$.

2.6. **EXAMPLE.** If the category \mathbf{C} in Example 2.3 has a homotopy theory, then we can pass to homotopy categories in that example to obtain another \mathbf{Set} -indexed category $\mathbf{Ho}(\mathbf{C}^A)$. However, since $\mathbf{Ho}(\mathbf{C}^A) \simeq (\mathbf{Ho}(\mathbf{C}))^A$ for any set A , we gain no extra generality thereby.

We will see in later sections that qualitatively different phenomena arise in “derived” situations, when the base category \mathbf{S} also has a “homotopy theory” which is taken into account somehow in the fibers. This is the case in Examples 2.4 and 2.5, but not in Example 2.6. Since Examples 2.4 and 2.5 are somewhat technically complicated, it will be useful to have a simpler example which exhibits some of the same derived phenomena. We can obtain such examples by replacing spaces by groupoids (which, up to homotopy, can be identified with homotopy 1-types).

2.7. **EXAMPLE.** If $\mathbf{S} = \mathbf{Gpd}$ is the category of groupoids and \mathbf{C} is any category, we can define $\mathcal{C}^A = \mathbf{C}^A$ to be the category of functors from the groupoid A to \mathbf{C} . For simplicity, we usually take \mathbf{C} to be abelian groups. This is an enlargement of Example 2.3, if we

consider sets as discrete groupoids. On the other hand, if A is a one-object groupoid, i.e. a group G , then \mathbf{Ab}^A can be identified with the category of modules over the group ring $\mathbb{Z}[G]$.

2.8. **EXAMPLE.** We have “derived phenomena” in Example 2.7 even when \mathbf{C} does not have its own homotopy theory, because the construction automatically “sees” the homotopy theory of groupoids. (For instance, we have $\mathbf{C}^A \simeq \mathbf{C}^B$ whenever $A \simeq B$ are *equivalent* groupoids, not only when they are isomorphic). However, we can also “derive it further” if \mathbf{C} *does* have a homotopy theory, obtaining a \mathbf{Gpd} -indexed category with $\mathcal{C}^A = \mathrm{Ho}(\mathbf{C}^A)$, where we invert the objectwise weak equivalences in \mathbf{C}^A . To maximize concreteness and familiarity, we may take $\mathbf{C} = \mathbf{Ch}_{\mathbb{Z}}$ to be the category of (unbounded) chain complexes, with its usual homotopy theory.

Note that in contrast to Example 2.6, when A is not discrete, $\mathrm{Ho}(\mathbf{C}^A)$ will generally be different from $(\mathrm{Ho}(\mathbf{C}))^A$. Thus, this example is genuinely different from Example 2.7.

Now in most of these examples, each category \mathcal{C}^A has a monoidal structure, which is respected by the transition functors. Namely:

- If \mathbf{C} is a monoidal category (such as \mathbf{Ab} or $\mathbf{Ch}_{\mathbb{Z}}$ with tensor product), then so is \mathbf{C}^A for any set or groupoid A ;
- When \mathbf{S} has finite limits, each slice category \mathbf{S}/A is cartesian monoidal;
- Each category \mathbf{Sp}_A has a parametrized smash product; and
- All of these monoidal structures descend to homotopy categories.

This “fiberwise” monoidal structure is simply described by the following definition.

2.9. **DEFINITION.** For a category \mathbf{S} , an **\mathbf{S} -indexed symmetric monoidal category** is a pseudofunctor from \mathbf{S}^{op} to the 2-category $\mathit{SymMonCat}$ of symmetric monoidal categories, strong symmetric monoidal functors, and monoidal natural transformations.

In elementary terms, this means an indexed category such that each \mathcal{C}^A is a symmetric monoidal category, each reindexing functor is strong symmetric monoidal, and each constraint isomorphism is a monoidal transformation. We write \otimes_A and I_A for the tensor product and unit object of the monoidal category \mathcal{C}^A , and refer to them as the *fiberwise* monoidal structure.

However, for many purposes it is more effective to express the monoidal structure differently. If \mathbf{S} has finite products, including a terminal object \star , then in any \mathbf{S} -indexed monoidal category \mathcal{C} we can define an *external product* functor

$$\begin{aligned} \mathcal{C}^A \times \mathcal{C}^B &\rightarrow \mathcal{C}^{A \times B} \\ (M, N) &\mapsto M \boxtimes N := (\pi_B^* M) \otimes_{A \times B} (\pi_A^* N). \end{aligned}$$

(Here $\pi_A: A \times B \rightarrow B$ and $\pi_B: A \times B \rightarrow A$ are the projections from the cartesian product.) This external product is coherently associative and unital, in a suitable sense (see [33]),

with unit object $U = I_*$. Moreover, we can recover the fiberwise monoidal structures (or *internal products*) from the external products, via the isomorphisms

$$M \otimes_A N \cong \Delta_A^*(M \boxtimes N) \tag{2.10}$$

$$I_A \cong \pi_A^* U. \tag{2.11}$$

(Here $\Delta_A: A \rightarrow A \times A$ is the diagonal of the cartesian product.) These hold for any $A \in \mathbf{S}$ and $M, N \in \mathcal{C}^A$, by monoidality of the functors f^* . In the same way we can construct natural isomorphisms

$$f^* M \boxtimes g^* N \cong (f \times g)^*(M \boxtimes N) \tag{2.12}$$

for any M, N, f, g for which this makes sense.

2.13. EXAMPLE. If \mathbf{C} is a symmetric monoidal category, then in the **Set**-indexed symmetric monoidal category $A \mapsto \mathbf{C}^A$ of Example 2.3, the fiberwise product of $M = (M_a)$ and $N = (N_a)$ in \mathbf{C}^A is defined by

$$(M \otimes_A N)_a = M_a \otimes N_a$$

whereas the external product of $M = (M_a) \in \mathbf{C}^A$ and $N = (N_b) \in \mathbf{C}^B$ is defined by

$$(M \boxtimes N)_{(a,b)} = M_a \otimes N_b.$$

The case of Example 2.7 is similar. Note that if A is one-object groupoid, hence a group G , and we identify \mathbf{Ab}^A with the category of $\mathbb{Z}[G]$ -modules, then its fiberwise monoidal structure is the tensor product over \mathbb{Z} , made into a $\mathbb{Z}[G]$ -module using the fact that $\mathbb{Z}[G]$ is a bialgebra. It is *not* a tensor product over $\mathbb{Z}[G]$, which wouldn't make sense anyway since $\mathbb{Z}[G]$ is not commutative.

2.14. EXAMPLE. If \mathbf{S} has finite limits, then in the \mathbf{S} -indexed symmetric monoidal category $A \mapsto \mathbf{S}/A$ of Example 2.4, the fiberwise product of $M, N \in \mathbf{S}/A$ is their fiber product (pullback):

$$M \otimes_A N = M \times_A N$$

whereas the external product of $M \in \mathbf{S}/A$ and $N \in \mathbf{S}/B$ is just their cartesian product, with the induced projection to $A \times B$:

$$M \boxtimes N = M \times N.$$

The case of Example 2.5 is similar, with cartesian products replaced by smash products. Both the fiberwise and external products of parametrized spectra are used in [22].

2.15. REMARK. When the base category \mathbf{S} is monoidal but not cartesian monoidal, we can still define “an external product” for \mathcal{C} to consist of functors $\mathcal{C}^A \times \mathcal{C}^B \rightarrow \mathcal{C}^{A \otimes B}$ which are coherently associative and unital. For instance, Example 2.2 has an external product, but not an internal one. However, our interest here is solely in the case when \mathbf{S} is cartesian monoidal.

3. Indexed coproducts

In order to construct a bicategory from an indexed symmetric monoidal category, and thereby prove our refinements of the symmetric monoidal trace, we will need one further piece of structure.

3.1. DEFINITION. Let \mathbf{S} be a cartesian monoidal category, and \mathcal{C} an \mathbf{S} -indexed category. We say that \mathcal{C} has **\mathbf{S} -indexed coproducts** if

- (i) Each reindexing functor f^* has a left adjoint $f_!$, and
- (ii) For any pullback square

$$\begin{array}{ccc} A & \xrightarrow{f} & B \\ h \downarrow & & \downarrow g \\ C & \xrightarrow{k} & D \end{array}$$

in \mathbf{S} , the composite

$$f_!h^* \longrightarrow f_!h^*k^*k_! \xrightarrow{\cong} f_!f^*g^*k_! \longrightarrow g^*k_!$$

is an isomorphism (the *Beck-Chevalley condition*).

If \mathcal{C} is symmetric monoidal, we say that \otimes **preserves indexed coproducts** (in each variable separately), or that the **projection formula holds**, if

- (iii) for any $f: A \rightarrow B$ in \mathbf{S} and any $M \in \mathcal{C}^B, N \in \mathcal{C}^A$, the canonical map

$$f_!(f^*M \otimes N) \rightarrow f_!(f^*M \otimes f^*f_!N) \cong f_!f^*(M \otimes f_!N) \rightarrow M \otimes f_!N$$

is an isomorphism.¹

We will only use the Beck-Chevalley condition for a few types of pullback squares. The basic such squares are shown in Figure 1. (These are all actually pullback squares in any cartesian monoidal category, whether or not it has pullbacks in general. See also [20, 30, 37].) We will also consider the transposes of Figures 1(b) and 1(c), as well as squares obtained from one of these by taking a cartesian product with a fixed object.

For ease of reference, we have assigned a name to each of these Beck-Chevalley conditions. We call Figure 1(a) “commutativity with reindexing” because the condition $(\text{id} \times g)_!(f \times \text{id})^* \cong (f \times \text{id})^*(\text{id} \times g)_!$ says that the indexed-coproduct functor $g_!$ commutes with the reindexing functor f^* . We call Figure 1(b) the “Frobenius axiom” because the condition $\Delta_!\Delta^* \cong (\Delta \times \text{id})^*(\text{id} \times \Delta)_!$ has the same form as one of the axioms of a Frobenius algebra. The name of Figure 1(c) will make more sense once we introduce string diagrams; see §9. Finally, we call Figure 1(d) “monic diagonals” because the fact that that square is a pullback says precisely that Δ_A is a monomorphism.

We have stated the definition of “ \otimes preserves indexed coproducts” in a form which may be most familiar, but we care most about the following equivalent statement.

¹If \mathcal{C} is not symmetric, we must assert also the analogous condition on the other side.

$$\begin{array}{ccc}
 \begin{array}{ccc}
 A \times C & \xrightarrow{f \times \text{id}_C} & B \times C \\
 \text{id}_A \times g \downarrow & & \downarrow \text{id}_B \times g \\
 A \times D & \xrightarrow{f \times \text{id}_D} & B \times D
 \end{array} & & \begin{array}{ccc}
 A & \xrightarrow{\Delta} & A \times A \\
 \Delta \downarrow & & \downarrow \text{id}_A \times \Delta \\
 A \times A & \xrightarrow{\Delta \times \text{id}_A} & A \times A \times A
 \end{array} \\
 \text{(a) Commutativity with reindexing} & & \text{(b) The Frobenius axiom}
 \end{array}$$

$$\begin{array}{ccc}
 \begin{array}{ccc}
 A & \xrightarrow{(\text{id}_A, f)} & A \times B \\
 f \downarrow & & \downarrow f \times \text{id}_B \\
 B & \xrightarrow{\Delta_B} & B \times B
 \end{array} & & \begin{array}{ccc}
 A & \xrightarrow{\text{id}_A} & A \\
 \text{id}_A \downarrow & & \downarrow \Delta \\
 A & \xrightarrow{\Delta} & A \times A
 \end{array} \\
 \text{(c) Sliding and splitting} & & \text{(d) Monic diagonals}
 \end{array}$$

Figure 1: Pullback squares involving products

3.2. LEMMA. *If \mathcal{C} is an indexed symmetric monoidal category with \mathbf{S} -indexed coproducts, then these are preserved by \otimes if and only if for any $f: A \rightarrow B$ and $g: C \rightarrow D$ in \mathbf{S} and any $M \in \mathcal{C}^A$, $N \in \mathcal{C}^C$, the composite*

$$\begin{aligned}
 (f \times g)_!(M \boxtimes N) &\longrightarrow (f \times g)_!(f^* f_! M \boxtimes g^* g_! N) \\
 &\xrightarrow{\cong} (f \times g)_!(f \times g)^*(f_! M \boxtimes g_! N) \\
 &\longrightarrow f_! M \boxtimes g_! N
 \end{aligned}$$

is an isomorphism.

PROOF (SKETCH) We will show that each of the two families of isomorphisms

$$f_!(f^* M \otimes N) \cong (M \otimes f_! N) \quad \text{and} \quad (f \times g)_!(M \boxtimes N) \cong (f_! M \boxtimes g_! N)$$

can be constructed from the other. We omit the proof that the constructed isomorphism in each case is in fact the canonical morphism exhibited above and in Definition 3.1; in each case this can be shown by a diagram chase, or by invoking the technology of “mates” from [19].

First, we observe that to prove the second isomorphism above, it suffices to consider the case when f or g is an identity, since then we can conclude

$$(f \times g)_!(M \boxtimes N) \cong (f \times \text{id})_!(\text{id} \times g)_!(M \boxtimes N) \cong (f \times \text{id})_!(M \boxtimes g_! N) \cong (f_! M \boxtimes g_! N).$$

Now assuming that \otimes preserves indexed coproducts, for any $f: A \rightarrow B$, $M \in \mathcal{C}^A$, and $N \in \mathcal{C}^C$, we have

$$\begin{aligned}
 (f \times \text{id}_C)_!(M \boxtimes N) &= (f \times \text{id}_C)_!(\pi_C^* M \otimes (f \times \text{id}_C)^* \pi_B^* N) \\
 &\cong (f \times \text{id}_C)_! \pi_C^* M \otimes \pi_A^* N \\
 &\cong \pi_C^* f_! M \otimes \pi_A^* N \\
 &= f_! M \boxtimes N
 \end{aligned}$$

using the assumption and the “commutativity with reindexing” Beck-Chevalley condition. Conversely, assuming the desired condition, then for any $f: A \rightarrow B$, $M \in \mathcal{C}^A$, and $N \in \mathcal{C}^B$, we have

$$\begin{aligned} f_! (M \otimes f^* N) &= f_! \Delta^* (M \boxtimes f^* N) \\ &\cong f_! (\text{id}_A, f)^* (M \boxtimes N) \\ &\cong \Delta^* (f \times \text{id}_B)_! (M \boxtimes N) \\ &\cong \Delta^* (f_! M \boxtimes N) \\ &= f_! M \otimes N \end{aligned}$$

using (2.12), the assumption, and the “sliding and splitting” Beck-Chevalley condition. ■

3.3. REMARK. In the case when the fiber categories are cartesian monoidal, the projection formula is also called the “Frobenius condition”. As remarked above, however, we reserve the adjective “Frobenius” for the Beck-Chevalley condition associated to Figure 1(b). The two are closely related, however:

- (i) Trimble has shown that the “Frobenius” Beck-Chevalley condition follows from either
 - (a) The “commutativity with reindexing” Beck-Chevalley condition and the projection formula (see [38]), or
 - (b) The Beck-Chevalley conditions “commutativity with reindexing” and “sliding and splitting” (see [37]).
- (ii) Walters has shown that in a context different than ours (a “cartesian bicategory”), the “Frobenius” and “sliding and splitting” Beck-Chevalley conditions imply the projection formula (as a special case of the “modular law”); see [39].

We now consider some examples of indexed categories with indexed coproducts.

3.4. EXAMPLE. If \mathbf{C} is a cocomplete symmetric monoidal category with ordinary coproducts that are preserved on both sides by \otimes (such as if it is closed), then the \mathbf{Set} -indexed category $A \mapsto \mathbf{C}^A$ has indexed coproducts preserved by \otimes , given by taking ordinary coproducts along the fibers of a set-function.

3.5. EXAMPLE. In the \mathbf{S} -indexed category $A \mapsto \mathbf{S}/A$, the left adjoints $f_!$ are given by composition with f , and the compatibility conditions are elementary lemmas about pullback squares.

In derived situations, the adjunctions $f_! \dashv f^*$ are usually unproblematic to obtain, as is the projection formula, but the Beck-Chevalley conditions are somewhat more subtle. In general, when \mathbf{S} has a homotopy theory that is “seen” by $A \mapsto \mathcal{C}^A$, we can usually only expect the Beck-Chevalley condition to hold for *homotopy* pullback squares in \mathbf{S} (that is, commutative squares for which the canonical map from the vertex to “the” homotopy

pullback is a suitable sort of equivalence). The pullback squares in Figures 1(a), 1(b), and 1(c) are always homotopy pullback squares, but the one in Figure 1(d) (monic diagonals) is not.

Motivated by these examples, we define an \mathbf{S} -indexed category to have **indexed homotopy coproducts** if the reindexing functors have left adjoints which satisfy the Beck-Chevalley condition for all homotopy pullback squares, including particularly those in Figures 1(a), 1(b), and 1(c) (and its dual), and all squares obtained from them by taking cartesian products with a fixed object. In order to ensure our results remain valid in derived contexts, we will never assume more than this, although we will see that some theorems reduce to a slightly simpler form if the Beck-Chevalley condition for Figure 1(d) also holds. We will refer to this latter case by saying that *diagonals are monic*. (Of course, diagonals are always monic in the base category \mathbf{S} ; the question is whether that monicity is “visible” to the fiber categories \mathcal{C}^A .)

3.6. EXAMPLE. In the examples $A \mapsto \mathbf{Top}/A$ and $A \mapsto \mathbf{Sp}_A$ of Examples 2.4 and 2.5, the adjunctions $f_! \dashv f^*$ are Quillen adjunctions, and thus descend to homotopy categories. The Beck-Chevalley condition is proven in [22] for pullbacks of fibrations (see also [34]). This includes “commutativity with reindexing” (Figure 1(a)) if B or D is a terminal object, but never the Frobenius axiom (Figure 1(b)).

For this reason, in [22] and [33], the presence of closed structure was invoked to avoid the Frobenius axiom. In hindsight, the reason this works is that closedness of the fibers and the reindexing functors implies the projection formula, by a standard argument—and together with “commutativity of reindexing” this actually implies the Frobenius axiom (see Remark 3.3).

However, there is a more direct argument: Figures 1(b) and 1(c) are *homotopy* pullback squares, and it is straightforward to show that if the Beck-Chevalley condition holds for pullbacks of fibrations, it also holds for all homotopy pullback squares. Thus, these two examples have indexed homotopy coproducts; the projection formula is also proven in [22].

3.7. EXAMPLE. In Example 2.7 of diagrams indexed over groupoids, the left adjoints $f_!$ are given by left Kan extension. If \mathbf{C} has a homotopy theory as in Example 2.8, then these adjunctions are also Quillen, and therefore descend to homotopy categories. In both cases, the Beck-Chevalley condition for homotopy pullback squares (which is to say, pseudo-pullbacks of groupoids) is straightforward to verify, as is the projection formula.

Note that this would not be true if instead of groupoids we allowed \mathbf{S} to consist of arbitrary small *categories*. In that case, the Beck-Chevalley condition would hold only for *comma squares* (squares containing a natural transformation which exhibits the upper-left vertex as (equivalent to) the comma category of the functors on the right and the bottom). In general, none of the squares in Figure 1 are comma squares.

Note that diagonals are not generally monic in Example 3.7, even when \mathbf{C} has no homotopy theory itself. As we remarked in §2, for “derived phenomena” it suffices that the homotopy theory of \mathbf{S} is “visible” to the indexed category.

Here are a couple additional examples of interest.

3.8. **EXAMPLE.** If \mathbf{S} is a category with pullbacks and a factorization system $(\mathcal{E}, \mathcal{M})$, then \mathcal{M} is automatically stable under pullback and composition, and so $A \mapsto \mathcal{M}/A$ defines an \mathbf{S} -indexed symmetric monoidal subcategory of $A \mapsto \mathbf{S}/A$. The $(\mathcal{E}, \mathcal{M})$ -factorizations give left adjoints $f_!$ for this indexed category, and it has indexed coproducts preserved by \times if \mathcal{E} is stable under pullback.

For instance, $(\mathcal{E}, \mathcal{M})$ could be the (regular epi, mono) factorization system on a regular category, such as **Set** or another topos. In this case we can also write this indexed category as $A \mapsto \text{Sub}(A)$, where $\text{Sub}(A)$ is the poset of subobjects of A .

3.9. **EXAMPLE.** The *hyperdoctrines* of Lawvere [20, 21] are, in particular, indexed cartesian monoidal categories with indexed coproducts preserved by \times . The Beck-Chevalley conditions for the squares in Figures 1(a) and 1(c) appear in [20, p. 8–9]. In this case we think of \mathbf{S} as a category of types (or contexts) and terms in a type theory, and the fiber categories as categories of propositions and proofs in a given context.

From now on, \mathcal{C} will always denote an \mathbf{S} -indexed symmetric monoidal category which has indexed homotopy coproducts preserved by \otimes .

3.10. **REMARK.** As mentioned in the introduction, in §§9–10 we will introduce a string diagram calculus for reasoning about indexed monoidal categories. This calculus greatly simplifies the constructions to be performed in subsequent sections, and is necessary (as a practical matter, though not a mathematical one) for the proofs of our main theorems in §§11–12. Some readers may find it helpful to have the string diagram calculus in mind all through the paper, and we encourage such readers to jump forward and read §§9–10 now.

4. Symmetric monoidal traces

As a preliminary to refining the symmetric monoidal trace, in this section we recall the definition of the latter and explain how it interacts with the indexed situation. Recall that an object M of a symmetric monoidal category is said to be **dualizable** if there exists an object M^\star , its **dual**, and evaluation and coevaluation morphisms $\eta: I \rightarrow M \otimes M^\star$ and $\epsilon: M^\star \otimes M \rightarrow I$ satisfying the usual triangle identities. In this case, the **trace** of a morphism $f: Q \otimes M \rightarrow M \otimes P$ is defined to be the composite:

$$Q \xrightarrow{\text{id} \otimes \eta} Q \otimes M \otimes M^\star \xrightarrow{f \otimes \text{id}} M \otimes P \otimes M^\star \xrightarrow{\cong} M^\star \otimes M \otimes P \xrightarrow{\epsilon \otimes \text{id}} P$$

The most basic case is when Q and P are the unit object I , so that the trace of an endomorphism $f: M \rightarrow M$ is a morphism $\text{tr}(f): I \rightarrow I$. References include [8, 17, 18].

4.1. **EXAMPLE.** Any finitely generated free abelian group is dualizable in **Ab**, and the trace of an endomorphism is the usual trace of its matrix with respect to any basis. (To be precise, it is the endomorphism $\mathbb{Z} \rightarrow \mathbb{Z}$ determined by *multiplying* by the usual numerical trace.) Similarly, in **Ch $_{\mathbb{Z}}$** , any bounded chain complex of finitely generated free abelian

groups is dualizable, and the trace of an endomorphism is (multiplying by) its *Lefschetz number* (the alternating sum of its degreewise traces).

4.2. EXAMPLE. A “homotopical” version of this takes place in the stable homotopy category of spectra. Any topological space gives rise to a spectrum called its *suspension spectrum*, and if the space was a finite-dimensional manifold, then its suspension spectrum is dualizable. Its dual is a desuspension of the stable normal bundle of an embedding of the manifold into a suitably-high-dimensional Euclidean space; the evaluation and coevaluation are Thom collapse maps.

Thus, any endomorphism of such a manifold gives rise to an endomorphism of its suspension spectrum. It turns out that the trace of this endomorphism can be identified with the *fixed-point index* of the original map; see [8]. The fixed-point index is a classical invariant which sums the index of the induced vector field in the neighborhood of each fixed point of the endomap.

It is easy to check that in a *cartesian* monoidal category, the only dualizable object is the terminal object. However, as remarked in the introduction, we often want to extract trace-like information from endomorphisms of objects in a cartesian monoidal category. Thus, to get out of the cartesian situation, we apply a monoidal functor landing in a non-cartesian monoidal category.

If the cartesian monoidal category \mathbf{S} is the base category of some indexed symmetric monoidal category with indexed coproducts preserved by \otimes , then there is a canonical such functor $\Sigma: \mathbf{S} \rightarrow \mathcal{C}^*$, defined as follows. We send an object A to

$$\Sigma(A) = (\pi_A)_! I_A \cong (\pi_A)_! (\pi_A)^* I_\star$$

and a morphism $\phi: A \rightarrow B$ to the composite

$$\Sigma(A) = (\pi_A)_! (\pi_A)^* I_\star \cong (\pi_B)_! \phi_! \phi^* (\pi_B)^* I_\star \longrightarrow (\pi_B)_! (\pi_B)^* I_\star = \Sigma(B). \tag{4.3}$$

Moreover, this functor Σ is strong symmetric monoidal:

$$\begin{aligned} \Sigma(A \times B) &= (\pi_{A \times B})_! \pi_{A \times B}^* I_\star \\ &\cong (\pi_{A \times B})_! \pi_{A \times B}^* (I_\star \otimes I_\star) \\ &\cong (\pi_{A \times B})_! (\pi_{A \times B}^* I_\star \otimes \pi_{A \times B}^* I_\star) \\ &\cong (\pi_A \times \pi_B)_! (\pi_B^* \pi_A^* I_\star \otimes \pi_A^* \pi_B^* I_\star) \\ &\cong (\pi_A)_! \pi_A^* I_\star \otimes (\pi_B)_! \pi_B^* I_\star \\ &= \Sigma A \otimes \Sigma B \end{aligned}$$

(This is especially obvious in string diagram notation; see Figure 6 on page 628. We leave the verification of the coherence of these isomorphisms to the reader.) If $\Sigma(A)$ is dualizable, for some $A \in \mathbf{S}$, then we can ask about the trace of $\Sigma(f)$.

4.4. **EXAMPLE.** For a cocomplete symmetric monoidal category \mathbf{C} and the **Set**-indexed category $A \mapsto \mathbf{C}^A$, we have $\mathbf{C}^* \cong \mathbf{C}$, and the functor Σ takes a set A to the *copower* $A \cdot I$ of the unit object $I \in \mathbf{C}$ by the set A (that is, the coproduct of A copies of I). If \mathbf{C} is \mathbf{Ab} , then $\Sigma(A)$ is the free abelian group on A , and similarly for modules, chain complexes, and so on.

In the case of abelian groups, if A is finite, then the abelian group $\Sigma(A) = \mathbb{Z}[A]$ is dualizable. And if $f: A \rightarrow A$ is an endofunction, then the trace of $\Sigma(f)$ is just the number of fixed points of f .

4.5. **EXAMPLE.** For the **Top**-indexed monoidal category $A \mapsto \mathrm{Ho}(\mathbf{Sp}_A)$, the category \mathcal{C}^* is the stable homotopy category of spectra. For a space A , we have $\Sigma(A) = \Sigma^\infty(A_+)$, the suspension spectrum of A with a disjoint basepoint. This should be regarded as a homotopical version of the “free abelian group” functor.

We have already remarked that if A is a finite-dimensional closed smooth manifold, then $\Sigma(A)$ is dualizable, and if $f: A \rightarrow A$ is an endomorphism, then the trace of $\Sigma(f)$ is the fixed-point index of f .

4.6. **EXAMPLE.** In the case of the underived groupoid-indexed category $A \mapsto \mathbf{Ab}^A$ from Example 2.7, we again have $\mathbf{Ab}^* \cong \mathbf{Ab}$, and $\Sigma(A)$ is just the free abelian group on the set of connected components of A . If A has finitely many connected components, then $\Sigma(A)$ is dualizable, and the trace of $\Sigma(f)$ is the number of “fixed components,” i.e. the number of isomorphism classes of objects x such that $f(x) \cong x$.

4.7. **EXAMPLE.** By contrast, for the derived version $A \mapsto \mathrm{Ho}(\mathbf{Ch}_{\mathbb{Z}}^A)$, the fiber over \star is $\mathrm{Ho}(\mathbf{Ch}_{\mathbb{Z}})$, and $\Sigma(A)$ is the homotopy colimit of the constant A -diagram of shape \mathbb{Z} . This can be represented concretely by the complex of chains on the nerve of A .

For an example of duality and trace, suppose that A is a *finitely generated free groupoid*; that is, a groupoid freely generated by some finite directed graph. Thus, it has finitely many objects, and the group of automorphisms of any object is a finitely generated free group. Then $\Sigma(A)$ is equivalent to the following chain complex concentrated in degrees 1 and 0:

$$\mathbb{Z}[A_1] \rightarrow \mathbb{Z}[A_0].$$

Here A_0 is the (finite) set of objects of A and A_1 a (finite) set of *generating* morphisms, and the differential sends each generator γ to $t(\gamma) - s(\gamma)$, the difference between its source and target objects. Since this complex is bounded and finitely generated free, it is dualizable in $\mathrm{Ho}(\mathbf{Ch}_{\mathbb{Z}})$; its dual can be identified with

$$\mathbb{Z}[A_0] \rightarrow \mathbb{Z}[A_1]$$

in degrees 0 and -1 , where now the differential sends an object x to the sum of all generating morphisms having target x , minus the sum of all generators having source x .

Now suppose $f: A \rightarrow A$ is an endomorphism of A . Therefore, it takes each object to another object, and each generating morphism to a composite of other generators

and inverses of generators. The induced endomorphism $\Sigma(f)$ corresponds, in the above representation, to the endomorphism

$$\begin{array}{ccc} \mathbb{Z}[A_1] & \longrightarrow & \mathbb{Z}[A_0] \\ \downarrow & & \downarrow \\ \mathbb{Z}[A_1] & \longrightarrow & \mathbb{Z}[A_0] \end{array}$$

which acts as f on objects, and sends each generating morphism to the *sum* of the generators occurring in its image, counted with multiplicity (where inverses of generators contribute negatively). Therefore, the trace $\text{tr}(f)$ is the sum of

- (i) the number of objects (literally) fixed by f , and
- (ii) for each generating morphism γ , the number of occurrences of γ^{-1} in the image $f(\gamma)$, minus the number of occurrences of γ in $f(\gamma)$.

(The perhaps-surprising signs in (ii) come from the sign in the symmetry isomorphism for the tensor product of chain complexes.) As it must be, the result is invariant under equivalence of groupoids (though not manifestly so from the above description).

Note that a finitely generated free groupoid is essentially the same thing as a finite 1-dimensional CW complex, up to homotopy. It is straightforward to check that under this equivalence, the trace calculated above agrees with the topological fixed-point index.

As mentioned at the beginning of this section, we can also consider traces of more general morphisms of the form $Q \otimes M \rightarrow M \otimes P$. Probably the most important symmetric monoidal trace of this form is the trace of

$$\Sigma(A) \xrightarrow{\Sigma(f)} \Sigma(A) \xrightarrow{\Sigma(\Delta_A)} \Sigma(A) \otimes \Sigma(A)$$

for some endomorphism $f: A \rightarrow A$ in \mathbf{S} , which we call the **transfer of f** . Note that the transfer is a morphism $I \rightarrow \Sigma(A)$.

4.8. EXAMPLE. Considering the **Set**-indexed category $A \mapsto \mathbf{Ab}^A$, the transfer of an endomorphism $f: A \rightarrow A$ of a finite set is a morphism $\mathbb{Z} \rightarrow \mathbb{Z}[A]$. This is equivalent to a single element of $\mathbb{Z}[A]$, which turns out to be just the formal sum of all the fixed points of f .

4.9. EXAMPLE. Considering the derived groupoid-indexed category $A \mapsto \text{Ho}(\mathbf{Ch}_{\mathbb{Z}}^A)$, if A is a finitely generated free groupoid, then using the small chain complex representing $\Sigma(A)$ from Example 4.7, the diagonal $\Sigma(A) \rightarrow \Sigma(A) \otimes \Sigma(A)$ can be represented by the morphism

$$\begin{array}{ccccc} 0 & \longrightarrow & \mathbb{Z}[A_1] & \longrightarrow & \mathbb{Z}[A_0] \\ \downarrow & & \downarrow & & \downarrow \\ \mathbb{Z}[A_1] \otimes \mathbb{Z}[A_1] & \longrightarrow & (\mathbb{Z}[A_1] \otimes \mathbb{Z}[A_0]) \oplus (\mathbb{Z}[A_0] \otimes \mathbb{Z}[A_1]) & \longrightarrow & \mathbb{Z}[A_0] \otimes \mathbb{Z}[A_0] \end{array}$$

which sends each object x to $x \otimes x$, and each generating morphism γ to

$$\gamma \otimes s(\gamma) + t(\gamma) \otimes \gamma$$

(where $s(\gamma)$ and $t(\gamma)$ are the source and target objects of γ , respectively). The transfer of an endomorphism f is then a morphism $\mathbb{Z} \rightarrow \Sigma(A)$ in $\mathrm{Ho}(\mathbf{Ch}_{\mathbb{Z}}^A)$, i.e. an element of $H_0(\Sigma(A))$, which is the free abelian group on the set of connected components of A . The coefficient of each component in this trace is 0 if that component is not mapped to itself, and otherwise it is the trace, as in Example 4.7, of f restricted to that component.

4.10. **EXAMPLE.** If M is a closed smooth manifold, the transfer of $f: M \rightarrow M$ is an element of the 0th stable homotopy group of M_+ . This latter group can be identified with the free abelian group on the set of connected components of M , and as in the previous example, the coefficient of each component in the trace is the sum of the indices of the fixed points in that component.

Thus, in general, we expect that the transfer of f separates out the contributions to $\mathrm{tr}(f)$ based on in which connected component of A they lie. (In the case of a plain set, of course, each element is its own connected component.)

In particular, the transfer is itself a refinement of the ordinary trace of $\Sigma(f)$. Note that the unique map $A \rightarrow \star$ to the terminal object induces an augmentation $\Sigma(A) \rightarrow \Sigma(\star) = I$; standard facts about the functoriality of traces then imply that the composite

$$I \xrightarrow{\mathrm{tr}(\Sigma(\Delta \circ f))} \Sigma(A) \longrightarrow I$$

is simply the trace of $\Sigma(f)$. In the above examples, the augmentation simply adds up all the coefficients, and this equality is then obvious.

5. Shadows from indexed monoidal categories

We now move on to our new refinements of the symmetric monoidal trace, which we will obtain by constructing a *bicategory* out of an indexed monoidal category and making use of the general notion of bicategorical trace introduced in [27, 29]. Bicategorical traces require some extra structure on the bicategory, however, so we begin by recalling that.

The notion of *duality* in a symmetric monoidal category, which we recalled in the previous section, generalizes easily to bicategories. A 1-cell $M: R \rightarrow S$ in a bicategory is **right dualizable** if there is a 1-cell $M^\star: S \rightarrow R$ called its **right dual**, and evaluation and coevaluation 2-cells $\eta: U_R \rightarrow M \odot M^\star$ and $\epsilon: M^\star \odot M \rightarrow U_S$ satisfying the usual triangle identities. (Here \odot denotes the bicategory composition and U_R is the unit 1-cell associated to the 0-cell R .) Dual pairs in a bicategory are often also called *adjoints*, since in the bicategory \mathcal{Cat} of categories, functors, and natural transformations they are precisely adjoint functors.

The definition of *trace* in a symmetric monoidal category requires the symmetry isomorphism, which is not present in a bicategory. In fact, it wouldn't even make sense to

ask for it, since in general $M \odot N$ and $N \odot M$ live in different hom-categories. However, as described in [27, 29], if we impose an extra structure on a bicategory, we can define an analogous notion of trace.

Specifically, we define a **shadow functor** on a bicategory \mathcal{B} to consist of functors

$$\langle\langle - \rangle\rangle: \mathcal{B}(R, R) \rightarrow \mathbf{T}$$

for each object R of \mathcal{B} and some fixed category \mathbf{T} , equipped with a natural isomorphism

$$\theta: \langle\langle M \odot N \rangle\rangle \xrightarrow{\cong} \langle\langle N \odot M \rangle\rangle$$

for $M: R \rightarrow S$ and $N: S \rightarrow R$, such that the following diagrams commute whenever they make sense:

$$\begin{array}{ccccc} \langle\langle (M \odot N) \odot P \rangle\rangle & \xrightarrow{\theta} & \langle\langle P \odot (M \odot N) \rangle\rangle & \xrightarrow{\langle\langle a \rangle\rangle} & \langle\langle (P \odot M) \odot N \rangle\rangle \\ \langle\langle a \rangle\rangle \downarrow & & & & \uparrow \theta \\ \langle\langle M \odot (N \odot P) \rangle\rangle & \xrightarrow{\theta} & \langle\langle (N \odot P) \odot M \rangle\rangle & \xrightarrow{\langle\langle a \rangle\rangle} & \langle\langle N \odot (P \odot M) \rangle\rangle \end{array}$$

$$\begin{array}{ccccc} \langle\langle M \odot U_R \rangle\rangle & \xrightarrow{\theta} & \langle\langle U_R \odot M \rangle\rangle & \xrightarrow{\theta} & \langle\langle M \odot U_R \rangle\rangle \\ & \searrow \langle\langle \tau \rangle\rangle & \downarrow \langle\langle t \rangle\rangle & \swarrow \langle\langle \tau \rangle\rangle & \\ & & \langle\langle M \rangle\rangle & & \end{array}$$

If \mathcal{B} is equipped with a shadow functor and M is a right dualizable 1-cell in \mathcal{B} , then the **trace** of a 2-cell $f: Q \odot M \rightarrow M \odot P$ is defined to be the composite:

$$\langle\langle Q \rangle\rangle \xrightarrow{\langle\langle \text{id} \odot \eta \rangle\rangle} \langle\langle Q \odot M \odot M^\star \rangle\rangle \xrightarrow{\langle\langle f \odot \text{id} \rangle\rangle} \langle\langle M \odot P \odot M^\star \rangle\rangle \xrightarrow{\theta} \langle\langle M^\star \odot M \odot P \rangle\rangle \xrightarrow{\langle\langle \epsilon \odot \text{id} \rangle\rangle} \langle\langle P \rangle\rangle$$

The most basic case is when Q and P are unit 1-cells, so the shadows of such units are particularly important; we write $\langle\langle A \rangle\rangle = \langle\langle U_A \rangle\rangle$ and call it *the shadow of A* .

The following example generally provides the best intuition.

5.1. EXAMPLE. There is a bicategory whose 0-cells are rings (not necessarily commutative), whose 1-cells are bimodules, and whose 2-cells are bimodule homomorphisms. Composition of 1-cells is done with the tensor product of bimodules, and the right dualizable bimodules $\mathbb{Z} \rightarrow R$ are precisely the finitely generated projective right R -modules. The shadow of an R - R -bimodule M is the abelian group $M/(r \cdot m = m \cdot r)$. The bicategorical trace specializes to the *Hattori-Stallings trace* from [11, 35], which takes values in $\langle\langle R \rangle\rangle$.

There are similar bicategories consisting of chain complexes of bimodules over rings, or DGAs. In this case the shadow is essentially Hochschild homology, and the bicategorical trace is the alternating sum of the levelwise Hattori-Stallings traces, just as in the symmetric monoidal category of chain complexes.

Now we turn to the task of constructing a bicategory from an indexed symmetric monoidal category. For motivation, let \mathbf{S} be a category with finite limits and consider the indexed symmetric monoidal category $A \mapsto \mathbf{S}/A$, whose fiberwise monoidal structures are given by pullback. There is also a bicategory whose composition operation is given by pullback in \mathbf{S} : its objects are those of \mathbf{S} and its 1-cells are *spans* $A \leftarrow M \rightarrow B$ in \mathbf{S} . Thus, let us consider how we might derive the structure of this bicategory from that of $A \mapsto \mathbf{S}/A$.

The category of 1-cells from A to B is isomorphic to $\mathbf{S}/(A \times B)$, which is just the fiber category over $A \times B$, so all we need to do is construct the units and composition. The central observation is that if $A \leftarrow M \rightarrow B$ and $B \leftarrow N \rightarrow C$ are spans, then their composite $M \times_B N$ is isomorphic to $\Delta_B^*(M \boxtimes N)$, where \boxtimes is the external (cartesian) product of our indexed category. Of course, $\Delta_B^*(M \boxtimes N)$ is actually an object of $\mathbf{S}/(A \times B \times C)$, so to make it into an object of $\mathbf{S}/(A \times C)$, we need to forget the map to B by pushing forward along the projection $\pi_B: A \times B \times C \rightarrow A \times C$; thus we have $M \times_B N \cong (\pi_B)_! \Delta_B^*(M \boxtimes N)$. Similarly, the unit span $A \leftarrow A \rightarrow A$ can be described (somewhat perversely) as $(\Delta_A)_! I_A$, where I_A is the unit object of the symmetric monoidal category \mathbf{S}/A (namely, the identity $A \rightarrow A$).

These considerations motivate the following theorem. Minus the statement about the shadow, this theorem was first observed by [22] in a particular case, and then generalized in [33].

5.2. THEOREM. *Let \mathbf{S} be a cartesian monoidal category, and let \mathcal{C} be an \mathbf{S} -indexed symmetric monoidal category with indexed homotopy coproducts preserved by \otimes . Then there is a bicategory \mathcal{C}/\mathbf{S} , whose 0-cells are the objects of \mathbf{S} , with*

$$\mathcal{C}/\mathbf{S}(A, B) = \mathcal{C}^{A \times B},$$

and with composition and units defined by

$$\begin{aligned} M \odot N &= (\mathrm{id}_A \times \pi_B \times \mathrm{id}_C)_! (\mathrm{id}_A \times \Delta_B \times \mathrm{id}_C)^*(M \boxtimes N) \quad \text{and} \\ U_A &= (\Delta_A)_! \pi_A^*(U) \end{aligned}$$

Moreover, \mathcal{C}/\mathbf{S} has a shadow with values in \mathcal{C}^* , defined by

$$\langle\langle M \rangle\rangle = (\pi_A)_! (\Delta_A)^* M.$$

Note that we can equivalently write the composition and units in terms of the internal monoidal structure, as $M \odot N = (\pi_B)_! (\pi_C^* M \otimes \pi_A^* N)$ and $U_A = (\Delta_A)_! I_A$.

PROOF. The associativity isomorphism is the composite

$$\begin{aligned} & (\mathrm{id}_A \times \pi_C \times \mathrm{id}_D)_! (\mathrm{id}_A \times \Delta_C \times \mathrm{id}_D)^* \left(\left((\mathrm{id}_A \times \pi_B \times \mathrm{id}_C)_! (\mathrm{id}_A \times \Delta_B \times \mathrm{id}_C)^*(M \boxtimes N) \right) \boxtimes P \right) \\ & \xrightarrow{\cong} (\mathrm{id}_A \times \pi_B \times \pi_C \times \mathrm{id}_D)_! (\mathrm{id}_A \times \Delta_B \times \Delta_C \times \mathrm{id}_D)^*(M \boxtimes N \boxtimes P) \\ & \xrightarrow{\cong} (\mathrm{id}_A \times \pi_B \times \mathrm{id}_D)_! (\mathrm{id}_A \times \Delta_B \times \mathrm{id}_D)^* \left(M \boxtimes \left((\mathrm{id}_B \times \pi_C \times \mathrm{id}_D)_! (\mathrm{id}_B \times \Delta_C \times \mathrm{id}_D)^*(N \boxtimes P) \right) \right). \end{aligned}$$

This uses the “commutativity with reindexing” Beck-Chevalley condition from Figure 1(a), along with pseudofunctoriality isomorphisms for the functors f^* and $f_!$. The unit isomorphism is

$$\begin{aligned} & (\mathrm{id}_A \times \pi_B \times \mathrm{id}_B)_!(\mathrm{id}_A \times \Delta_B \times \mathrm{id}_B)^*(M \boxtimes (\Delta_B)_!\pi_B^*(U)) \\ & \xrightarrow{\cong} (\mathrm{id}_A \times \pi_B \times \mathrm{id}_B)_!(\mathrm{id}_A \times \Delta_B)_!(\mathrm{id}_A \times \Delta_B)^*(\mathrm{id}_A \times \mathrm{id}_B \times \pi_B)^*(M \boxtimes U) \\ & \xrightarrow{\cong} M \end{aligned}$$

This uses the “Frobenius” isomorphism from Figure 1(b), together with pseudofunctoriality for the equality $(\pi \times \mathrm{id})\Delta = \mathrm{id}$. More details, including proofs of the coherence axioms, can be found in [33].

To define the isomorphism $\langle\langle M \odot N \rangle\rangle \cong \langle\langle N \odot M \rangle\rangle$, first note that for $P \in \mathcal{C}^A$ and $Q \in \mathcal{C}^B$ there is an isomorphism

$$P \boxtimes Q \rightarrow \gamma^*(Q \boxtimes P), \quad (5.3)$$

where $\gamma: A \times B \cong B \times A$ is the symmetry isomorphism of \mathbf{S} . The isomorphism (5.3) is defined by

$$\begin{aligned} P \boxtimes Q & := (\mathrm{id}_A \times \pi_B)^*P \otimes_{A \times B} (\pi_A \times \mathrm{id}_B)^*Q \\ & \xrightarrow{\gamma} (\pi_A \times \mathrm{id}_B)^*Q \otimes_{A \times B} (\mathrm{id}_A \times \pi_B)^*P \\ & \cong \gamma^*(\mathrm{id}_B \times \pi_A)^*Q \otimes_{A \times B} \gamma^*(\pi_B \times \mathrm{id}_A)^*P \\ & \cong \gamma^*((\mathrm{id}_B \times \pi_A)^*Q \otimes_{B \times A} (\pi_B \times \mathrm{id}_A)^*P) \\ & \cong \gamma^*(Q \boxtimes P) \end{aligned}$$

where the arrow labeled γ denotes the symmetry isomorphism of $\mathcal{C}^{A \times B}$. Given this, we can define the isomorphism θ to be the composite

$$\begin{aligned} & (\pi_A)_!\Delta_A^*((\mathrm{id}_A \times \pi_B \times \mathrm{id}_A)_!(\mathrm{id}_A \times \Delta_B \times \mathrm{id}_A)^*(M \boxtimes N)) \\ & \cong (\pi_A)_!\Delta_A^*(\mathrm{id}_A \times \mathrm{id}_A \times \pi_B)_!\gamma_!(\mathrm{id}_A \times \Delta_B \times \mathrm{id}_A)^*(M \boxtimes N) \\ & \cong (\pi_A)_!(\mathrm{id}_A \times \pi_B)_!(\Delta_A \times \mathrm{id}_B)^*\gamma_!(\mathrm{id}_A \times \Delta_B \times \mathrm{id}_A)^*(M \boxtimes N) \\ & \cong (\pi_A)_!(\mathrm{id}_A \times \pi_B)_!(\Delta_A \times \mathrm{id}_B)^*(\mathrm{id}_A \times \mathrm{id}_A \times \Delta_B)^*(\mathrm{id}_A \times \gamma)_!(M \boxtimes N) \\ & \cong (\pi_A \times \pi_B)_!(\Delta_A \times \Delta_B)^*(\mathrm{id}_A \times \gamma)_!(M \boxtimes N) \\ & \xrightarrow{(5.3)} (\pi_A \times \pi_B)_!(\Delta_A \times \Delta_B)^*(\mathrm{id}_A \times \gamma)_!\gamma^*(N \boxtimes M) \\ & \cong (\pi_B)_!(\pi_A \times \mathrm{id}_B)_!(\mathrm{id}_A \times \Delta_B)^*(\Delta_A \times \mathrm{id}_B \times \mathrm{id}_B)^*\gamma^*(N \boxtimes M) \\ & \cong (\pi_B)_!(\pi_A \times \mathrm{id}_B)_!(\mathrm{id}_A \times \Delta_B)^*\gamma^*(\mathrm{id}_B \times \Delta_A \times \mathrm{id}_B)^*(N \boxtimes M) \\ & \cong (\pi_B)_!(\Delta_B)^*(\pi_A \times \mathrm{id}_B \times \mathrm{id}_B)_!\gamma^*(\mathrm{id}_B \times \Delta_A \times \mathrm{id}_B)^*(N \boxtimes M) \\ & \cong (\pi_B)_!(\Delta_B)^*(\mathrm{id}_B \times \pi_A \times \mathrm{id}_B)_!(\mathrm{id}_B \times \Delta_A \times \mathrm{id}_B)^*(N \boxtimes M) \end{aligned}$$

where γ denotes various symmetry isomorphisms in \mathcal{C} . The axioms of a shadow functor can be proven by adapting the methods of [33]. \blacksquare

5.4. **REMARK.** We will see in §9 that the isomorphisms in the proof of Theorem 5.2 are *dramatically* simplified by the use of string diagram notation. Figure 5 on page 628 shows the operations of \mathcal{C}/\mathbf{S} ; Figure 9 on page 629 shows the associativity and unit isomorphisms; and Figure 10 on page 630 shows the shadow isomorphism.

5.5. **REMARK.** The bicategory constructed from an indexed symmetric monoidal category as in Theorem 5.2 has additional structure: it is a symmetric monoidal bicategory in which each object is its own dual. (In [33] it is shown to be a “fibrant” symmetric monoidal double category, and in [32] it is shown how this structure gives rise to a symmetric monoidal bicategory.) The shadow defined above can also be constructed from this additional structure, as suggested in [29], but for our purposes it is easier to construct it directly.

We now consider some examples of Theorem 5.2.

5.6. **EXAMPLE.** If \mathbf{S} has finite limits, then from the indexed symmetric monoidal category $A \mapsto \mathbf{S}/A$, Theorem 5.2 produces the bicategory of spans in \mathbf{S} . The shadow of an endospan $A \leftarrow M \rightarrow A$ is the pullback $(\Delta_A)^*M$, regarded as an object of $\mathbf{S} = \mathbf{S}/\star$.

5.7. **EXAMPLE.** If \mathbf{C} is a symmetric monoidal category with ordinary coproducts preserved by \otimes , then from the **Set**-indexed symmetric monoidal category $A \mapsto \mathbf{C}^A$, this theorem produces the bicategory of \mathbf{C} -valued *matrices*. Its objects are sets, of course, and its 1-cells $A \rightarrow B$ are $(A \times B)$ -indexed families of objects of \mathbf{C} , while its composition is by “matrix multiplication.”

The shadow of an A -by- A matrix (M_{a_1, a_2}) is its “trace” $\coprod_a M_{a, a}$. In particular, the shadow of a set A is $\coprod_{a \in A} I$, which is isomorphic to the copower $A \cdot I$.

5.8. **EXAMPLE.** If \mathbf{S} is a regular category, then from the \mathbf{S} -indexed monoidal category $A \mapsto \text{Sub}(A)$, Theorem 5.2 produces the bicategory of *relations* in \mathbf{S} . This bicategory reflects all the logical structure of subobjects in \mathbf{S} ; see for instance [10]. The shadow of a relation $R \hookrightarrow A \times A$ is again the pullback Δ^*R , which we can interpret as “the object of all $a \in A$ such that $R(a, a)$ ”.

5.9. **EXAMPLE.** From Example 2.7, Theorem 5.2 produces a bicategory whose objects are groupoids and whose 1-cells $A \rightarrow B$ form the diagram category $\mathbf{C}^{A \times B}$. Since every groupoid is canonically isomorphic to its opposite, we can equivalently regard this category as $\mathbf{C}^{A^{op} \times B}$, whose objects are variously called (\mathbf{C} -valued) “profunctors”, “distributors”, “bimodules”, or “relators” from A to B . When we do this, the composition of 1-cells produced by Theorem 5.2 becomes identified with the usual *tensor product of functors* construction with which we compose profunctors. The unit object is the profunctor defined by $U_A(a_1, a_2) = \text{hom}_A(a_1, a_2) \cdot I$, where I is the unit object of \mathbf{C} .

Similarly, the shadow of a profunctor $M: A \rightarrow A$ is the coend

$$\int^{a \in A} M(a, a).$$

In particular, the shadow of the unit U_A is

$$\int^{a \in A} \text{hom}_A(a, a) \cdot I \cong \left(\int^{a \in A} \text{hom}_A(a, a) \right) \cdot I.$$

The set $\int^{a \in A} \text{hom}_A(a, a)$ is the quotient of the set $\coprod_a \text{hom}_A(a, a)$ of all automorphisms of objects of A by the “conjugacy” relation $\gamma \sim \alpha^{-1}\gamma\alpha$. Note that this set decomposes into a disjoint union, over all connected components of A , of the set of conjugacy classes of the isotropy group² of that connected component.

This is the usual bicategory of groupoids and \mathbf{C} -valued profunctors, with its usual shadow (as discussed in [29]). Of course, this bicategory sits in a larger bicategory of *categories* and profunctors, but for the reasons given in Example 3.7, we cannot produce the latter using Theorem 5.2.

An important special case occurs when $\mathbf{C} = \mathbf{Ab}$ is the category of abelian groups, and we restrict to groups (that is, one-object groupoids). In that case, an \mathbf{Ab} -valued profunctor $G \leftrightarrow H$ can be identified with a bimodule between the group rings $\mathbb{Z}[G]$ and $\mathbb{Z}[H]$. The above formula for the shadow of a group, in the bicategory of profunctors, gives us the free abelian group on its set of conjugacy classes:

$$\langle\langle G \rangle\rangle = \mathbb{Z}[\text{Conj}(G)]$$

which is also the shadow $\langle\langle \mathbb{Z}[G] \rangle\rangle$ of its group ring in the bicategory of bimodules. Thus, the sub-bicategory of \mathbf{Ab} -valued profunctors between groups can be identified with the sub-bicategory of Example 5.1 determined by group rings. (Of course, we can also replace \mathbb{Z} by any commutative ring.)

Note that for this example, it is important that the proof of Theorem 5.2 only used the Beck-Chevalley condition for *homotopy* pullback squares. The same is true of the next example.

5.10. EXAMPLE. The indexed monoidal categories $A \mapsto \mathbf{Sp}_A$ and $A \mapsto \text{Ho}(\mathbf{Sp}_A)$ of parametrized spectra give rise to point-set-level and derived bicategories. The latter bicategory is the one studied in [22].

In general, shadows in Example 5.10 do not have a simple description, but in the important case of the shadow of unit 1-cells, we can say more. In fact, there is a general way to compute the shadow of a unit 1-cell which works in most examples. The definition gives us:

$$\langle\langle A \rangle\rangle = \langle\langle U_A \rangle\rangle = (\pi_A)_! (\Delta_A)^* U_A = (\pi_A)_! (\Delta_A)^* (\Delta_A)_! I_A.$$

Recalling the functor $\Sigma(A) = (\pi_A)_! I_A$ from §4, we see that there is a canonical morphism $\Sigma(A) \rightarrow \langle\langle A \rangle\rangle$ induced by the unit of the adjunction $\Delta_! \dashv \Delta^*$. If diagonals are monic, this is

²The isotropy group of a connected component of A is just the group of automorphisms of any object in that component. It is well-defined up to conjugacy, so its set of conjugacy classes is well-defined up to isomorphism.

an isomorphism, so that we can identify $\langle\langle A \rangle\rangle$ with $\Sigma(A)$. This is the case in Examples 5.6, 5.7, and 5.8.

On the other hand, if diagonals are not monic, as in Examples 5.9 and 5.10, then $\langle\langle A \rangle\rangle$ can be noticeably different from $\Sigma(A)$. However, we can compute $\langle\langle A \rangle\rangle$ if we can find a different square

$$\begin{array}{ccc} LA & \xrightarrow{p} & A \\ q \downarrow & & \downarrow \Delta \\ A & \xrightarrow{\Delta} & A \times A, \end{array}$$

for some object LA , which is a homotopy pullback (and hence will usually satisfy the Beck-Chevalley condition, although it is not one of the squares listed in Figure 1). For if this is the case, we have

$$\langle\langle A \rangle\rangle = (\pi_A)_! \Delta_A^* (\Delta_A)_! I_A \cong (\pi_A)_! p_! q^* I_A \cong (\pi_{LA})_! I_{LA} = \Sigma(LA).$$

Moreover, in this case the map $\Sigma(A) \rightarrow \langle\langle A \rangle\rangle = \Sigma(LA)$ is simply the image by Σ of the comparison map $A \rightarrow LA$ (which is induced by the homotopy pullback property of LA).

5.11. **EXAMPLE.** In **Top**, the homotopy pullback of Δ_A with itself is the *free loop space* LA : its points are continuous maps $S^1 \rightarrow A$ (no basepoints involved). Therefore, in the bicategory of parametrized spectra, the shadow $\langle\langle A \rangle\rangle$ is $\Sigma(LA) = \Sigma_+^\infty(LA)$, the suspension spectrum of the free loop space of A . The map $A \rightarrow LA$ sends each point $x \in A$ to the constant loop at x .

5.12. **EXAMPLE.** We can compute the shadow in Example 5.9 in this way too. When A is a groupoid, the homotopy pullback (or pseudo-pullback) of Δ_A with itself is a groupoid LA whose objects are pairs (x, γ) , where x is an object of A and $\gamma \in \text{hom}_A(x, x)$, and whose morphisms are “conjugations”. The map $A \rightarrow LA$ sends each object x to (x, id_x) .

Now recall that in the underived case of **Ab**-valued profunctors, $\Sigma(B)$ is the free abelian group on the set of connected components of B . Therefore, we recover the fact that $\langle\langle A \rangle\rangle$ is the free abelian group on the set of conjugacy classes of automorphisms in A .

5.13. **EXAMPLE.** The derived version of the profunctors example is perhaps easier to see from the free-loop-space perspective. Now the shadow of A is the homotopy quotient of the LA -diagram constant at I . When **C** is chain complexes, this just gives the complex of chains on the nerve of LA .

The nerve of LA , however, is isomorphic to what is called the *cyclic nerve* of A . This is a simplicial set ZA whose n -simplices are “composable loops” of $n + 1$ morphisms in A :

$$x_0 \xrightarrow{\alpha_0} x_1 \xrightarrow{\alpha_1} \cdots \xrightarrow{\alpha_{n-1}} x_n \xrightarrow{\alpha_n} x_0$$

(note that the starting and ending objects are the same). The face maps of ZA compose pairs of adjacent morphisms, with the final face map composing around the loop:

$$(\alpha_0, \dots, \alpha_{n-1}, \alpha_n) \mapsto (\alpha_n \alpha_0, \dots, \alpha_{n-1}).$$

The isomorphism $N(LA) \cong ZA$ is as follows: given an n -simplex

$$(x_0, \gamma_0) \xrightarrow{\alpha_1} (x_1, \gamma_1) \xrightarrow{\alpha_2} \cdots \xrightarrow{\alpha_n} (x_n, \gamma_n)$$

in $N(LA)$, where by definition $\alpha_{i+1}^{-1}\gamma_i\alpha_{i+1} = \gamma_{i+1}$, we send it to the n -simplex

$$(\alpha_0, \alpha_1, \dots, \alpha_n)$$

in ZA , where by definition

$$\alpha_0 := \alpha_n^{-1} \cdots \alpha_1^{-1} \gamma_0.$$

It is straightforward to check that this is an isomorphism of simplicial sets (in fact, an isomorphism of “cyclic sets”). See, for instance, [2].

The reason for passing across this isomorphism is that when A is a group G , the chains on ZG form exactly the *Hochschild complex* of the group ring $\mathbb{Z}[G]$ (as a bimodule over itself). More generally, when A is a skeletal groupoid, the chains on ZA are the direct sum of the Hochschild complexes of $\mathbb{Z}[G]$, as G runs over the isotropy groups of connected components of A . If A is not skeletal, then the chains on ZA are homotopy equivalent to those on its skeleton. Thus, for any groupoid A , we have a quasi-isomorphism

$$\langle\langle A \rangle\rangle \simeq \bigoplus_{x \in \pi_0(A)} HH_*\left(\mathbb{Z}[\text{hom}_A(x, x)]\right).$$

Note that when using $\langle\langle G \rangle\rangle$ as the target of a map into or out of \mathbb{Z} , the difference between the derived and underived cases is negligible. This is because maps into and out of \mathbb{Z} are determined, up to homotopy, by the 0th homology of a chain complex, and the 0th Hochschild homology of $\mathbb{Z}[G]$ is exactly its underived shadow: the free abelian group on its set of conjugacy classes. These two cases cover most of our examples, so higher Hochschild homology will not make much of an appearance hereafter.

6. Fiberwise duality

At this point we have all the machinery necessary to prove the “fiberwise” comparison Theorem 1.1 and its generalizations, by considering duality and trace in the bicategory \mathcal{C}/\mathcal{S} . From now on, we will mostly restrict attention to the three examples mentioned in the introduction:

- (i) The **Set**-indexed category $A \mapsto \mathbf{Ab}^A$, where f^* is given by reindexing and $f_!$ is given by coproducts over the fibers of f . In this case \mathcal{C}/\mathcal{S} is the bicategory of **Ab**-valued matrices.
- (ii) The **Top**-indexed category $A \mapsto \text{Ho}(\mathbf{Sp}_A)$ of parametrized spectra, where f^* is given by pullback and $f_!$ by pushout along f . In this case \mathcal{C}/\mathcal{S} is the bicategory of parametrized spectra from [22].

- (iii) The **Gpd**-indexed category $A \mapsto \text{Ho}(\mathbf{Ch}_{\mathbb{Z}}^A)$, where f^* is given by reindexing and $f_!$ by homotopy left Kan extension. In this case \mathcal{C}/\mathbf{s} is equivalent to the derived bicategory of $\mathbf{Ch}_{\mathbb{Z}}$ -valued profunctors over groupoids.

Until now we have also considered other examples, such as $A \mapsto \mathbf{S}/A$ and $A \mapsto \text{Ho}(\mathbf{Top}/A)$. However, in order to have interesting dualities, it is generally necessary for the fibers to be “additive” in some sense, as is the case in the examples above.

We now observe that there are two canonical “embeddings” of the fiber categories \mathcal{C}^A into \mathcal{C}/\mathbf{s} . Namely, we can consider an object $M \in \mathcal{C}^A$ either as a 1-cell $\widehat{M}: A \rightarrow \star$ or a 1-cell $\widetilde{M}: \star \rightarrow A$ in \mathcal{C}/\mathbf{s} , since the isomorphisms $\star \times A \cong A \cong A \times \star$ induce equivalences

$$\begin{aligned} \mathcal{C}^A &\simeq \mathcal{C}^{A \times \star} = \mathcal{C}/\mathbf{s}(A, \star) && \text{and} \\ \mathcal{C}^A &\simeq \mathcal{C}^{\star \times A} = \mathcal{C}/\mathbf{s}(\star, A). \end{aligned}$$

However, unlike \mathcal{C}^A , which is of course a symmetric monoidal category, the bicategory structure of \mathcal{C}/\mathbf{s} does not endow $\mathcal{C}/\mathbf{s}(A, \star)$ or $\mathcal{C}/\mathbf{s}(\star, A)$ with monoidal structures; rather, it equips them with two composition functors

$$\begin{aligned} \odot: \mathcal{C}/\mathbf{s}(A, \star) \times \mathcal{C}/\mathbf{s}(\star, A) &\longrightarrow \mathcal{C}/\mathbf{s}(A, A) \simeq \mathcal{C}^{A \times A} \\ \odot: \mathcal{C}/\mathbf{s}(\star, A) \times \mathcal{C}/\mathbf{s}(A, \star) &\longrightarrow \mathcal{C}/\mathbf{s}(\star, \star) \simeq \mathcal{C}^{\star}. \end{aligned}$$

The relationship of these functors to the monoidal structure of \mathcal{C}^A is easily obtained from the definition of \odot ; we have

$$\begin{aligned} \widehat{M} \odot \check{N} &\cong M \boxtimes N \in \mathcal{C}^{A \times A} \\ \widetilde{M} \odot \widehat{N} &\cong (\pi_A)_!(M \otimes_A N) \in \mathcal{C}^{\star} \end{aligned}$$

From this we can deduce fundamental relationships between duality and trace in the fiber categories of \mathcal{C} versus the bicategory \mathcal{C}/\mathbf{s} . All proofs in this section involve fairly lengthy string diagram calculations, so we defer them to §11.

The following theorem was proven, for parametrized spectra, in [22].

6.1. THEOREM. *An object $M \in \mathcal{C}^A$ is dualizable in the symmetric monoidal category \mathcal{C}^A if and only if $\widehat{M}: A \rightarrow \star$ is right dualizable in the bicategory \mathcal{C}/\mathbf{s} . Moreover, we have $(\widehat{M})^{\star} \cong \widetilde{M^{\star}}$.*

Therefore, duality in \mathcal{C}/\mathbf{s} includes, as a special case, duality in the fiber categories \mathcal{C}^A . The following proposition helps to clarify the nature of this duality.

6.2. PROPOSITION.

- (i) *If $M \in \mathcal{C}^A$ is dualizable in \mathcal{C}^A , then for any morphism $a: \star \rightarrow A$, we have that $a^*(M) \in \mathcal{C}^{\star}$ is dualizable in \mathcal{C}^{\star} .*
- (ii) *Suppose that*

- (a) the fiber categories of \mathcal{C} are all closed monoidal, as are the reindexing functors f^* , and
- (b) the collection of all functors $a^*: \mathcal{C}^A \rightarrow \mathcal{C}^*$ is jointly conservative (isomorphism-reflecting).

Then if $a^*(M) \in \mathcal{C}^*$ is dualizable for every $a: \star \rightarrow A$, it follows that M is dualizable in \mathcal{C}^A .

PROOF. The first statement is easy, since strong monoidal functors (like a^*) always preserve dualizability. The second is proven in [22, 15.1.1] for parametrized spectra, but the proof requires only the two properties mentioned above. ■

In our examples, a morphism $a: \star \rightarrow A$ is the same as a “point” of A , and the functor a^* computes the “fiber” of M over that point. Thus, since conditions (ii)a and (ii)b above hold quite frequently (in particular, they hold in our three primary examples), it is usually the case that M is dualizable in \mathcal{C}^A if and only if each of its fibers is dualizable in \mathcal{C}^* . Thus (following [22]), in the situation of Theorem 6.1 we say that M is **fiberwise dualizable**.

We can now state an equivalent form of Theorem 1.1.

6.3. THEOREM. *Let $M \in \mathcal{C}^A$ be fiberwise dualizable and let $f: M \rightarrow M$ be an endomorphism in \mathcal{C}^A . Then the diagram*

$$\begin{array}{ccc}
 (\pi_A)_! I_A & \longrightarrow & \langle\langle A \rangle\rangle \\
 (\pi_A)_! \text{tr}(f) \downarrow & & \downarrow \text{tr}(\widehat{f}) \\
 (\pi_A)_! I_A & \longrightarrow & I_\star
 \end{array} \tag{6.4}$$

commutes.

Note that the lower-left composite in (6.4) is simply the adjunct of

$$\text{tr}(f): I_A \rightarrow I_A \cong \pi_A^* I_\star$$

under the adjunction $(\pi_A)_! \dashv \pi_A^*$, so the conclusion of the theorem is equivalent to the assertion that the symmetric monoidal trace of $f: M \rightarrow M$ is equal to the composite

$$I_A \rightarrow (\pi_A)^*(\pi_A)_!(\Delta_A)^*(\Delta_A)_! I_A = (\pi_A)^* \langle\langle A \rangle\rangle \xrightarrow{(\pi_A)^* \text{tr}(\widehat{f})} (\pi_A)^* I_\star = I_A.$$

(This is the form in which we stated Theorem 1.1.) In particular, $\text{tr}(f)$ can be recovered from $\text{tr}(\widehat{f})$. Thus, the bicategorical trace $\text{tr}(\widehat{f})$ carries at least as much information as the fiberwise trace $\text{tr}(f)$.

Moreover, the top morphism in (6.4) is an instance of the “monic diagonals” Beck-Chevalley morphism. (In fact, it is exactly the comparison morphism $\Sigma(A) \rightarrow \langle\langle A \rangle\rangle$ that we saw in §5.) Thus, if diagonals are monic, then the two traces carry exactly the same information, while otherwise the bicategorical trace can be strictly more informative.

We now consider fiberwise traces in our three primary examples.

6.5. **EXAMPLE.** By Proposition 6.2, a **Set**-indexed family of abelian groups $(M_a)_{a \in A} \in \mathbf{Ab}^A$ is dualizable just when each M_a is a dualizable abelian group, which is to say it is finitely generated and projective. If $f = (f_a): M \rightarrow M$ is an endomorphism, then its trace in \mathbf{Ab}^A is the family of traces of the endomorphisms $f_a: M_a \rightarrow M_a$:

$$\mathrm{tr}(f) = (\mathrm{tr} f_a)_{a \in A}: (\mathbb{Z})_{a \in A} \longrightarrow (\mathbb{Z})_{a \in A}.$$

Since diagonals are monic in this case, the trace of \widehat{f} is just the adjunct of this under the adjunction $(\pi_A)_! \dashv (\pi_A)^*$, which turns out to be the induced map

$$\bigoplus_a \mathbb{Z} \xrightarrow{[\mathrm{tr}(f_a)]} \mathbb{Z}.$$

Of course, by the universal property of a coproduct, knowing this morphism is the same as knowing the individual morphisms $\mathrm{tr}(f_a)$.

6.6. **EXAMPLE.** Again, by Proposition 6.2, a **Gpd**-indexed diagram M of chain complexes is dualizable just when each chain complex $M(a)$ is dualizable. In the underived context, this means it is finitely generated and projective, while in the derived case it just means it is quasi-isomorphic to such a complex. The symmetric monoidal unit $I_A \in \mathbf{Ch}_{\mathbb{Z}}^A$ is just the constant functor at the unit object $\mathbb{Z} \in \mathbf{Ch}_{\mathbb{Z}}$, and for an endomorphism $f: M \rightarrow M$, the symmetric monoidal trace is the natural transformation $I_A \rightarrow I_A$ consisting of the individual traces of the morphisms $f_a: M(a) \rightarrow M(a)$.

As for the bicategorical trace, recall that the shadow of a groupoid A is the copower of the unit $I = \mathbb{Z}$ by the set of conjugacy classes of automorphisms in A . A computation shows that $\mathrm{tr}(\widehat{f}): \langle\langle A \rangle\rangle \rightarrow \mathbb{Z}$ sends each automorphism $\gamma \in \mathrm{hom}_A(a, a)$ to the ordinary symmetric monoidal trace of the composite

$$M(a) \xrightarrow{M(\gamma)} M(a) \xrightarrow{f_a} M(a).$$

(Cyclicity of the trace implies that this is invariant under conjugacy.) Since the unit $I_A \rightarrow (\pi_A)^*\langle\langle A \rangle\rangle$ picks out the identities, it is clear that the composite of these two will find exactly the traces of the f_a 's. As we saw above, this is the symmetric monoidal traces in $\mathbf{Ch}_{\mathbb{Z}}^A$, as asserted by Theorem 6.1. Note that in this case, the bicategorical trace does carry strictly more information.

6.7. **EXAMPLE.** Once again, by Proposition 6.2, a parameterized spectrum E over B is fiberwise dualizable if and only if each of its fibers is dualizable in the usual stable homotopy category $\mathrm{Ho}(\mathbf{Sp})$.

In particular, if $p: E \rightarrow B$ is a fibration with fiber F such that $\Sigma^\infty(F_+)$ is dualizable, then the “fiberwise suspension spectrum” $\Sigma_B^\infty(E \amalg B)$ is fiberwise dualizable over B . In this case, for a fiberwise map $f: E \rightarrow E$, the symmetric monoidal trace of $\Sigma_B^\infty(f \amalg \mathrm{id}_B)$ in $\mathrm{Ho}(\mathbf{Sp}_B)$ is the *fiberwise fixed point index* of f , [7]. This is a fiberwise endomorphism of the “parametrized sphere spectrum” S_B over B (this is the unit object I_A). Since $S_B \simeq$

$(\pi_B)^*S$, where S is the ordinary sphere spectrum, by adjunction this map is equivalent to a map

$$(\pi_B)_!S_B \cong \Sigma^\infty(B_+) \rightarrow S.$$

The homotopy classes of maps $\Sigma^\infty(B_+) \rightarrow S$ make up the 0^{th} stable cohomotopy of B_+ . If $b: \star \rightarrow B$ is the inclusion of a point b in B , the composite

$$S = \Sigma^\infty(\star_+) \xrightarrow{\Sigma^\infty(b_+)} \Sigma^\infty(B_+) \xrightarrow{\text{tr}(\Sigma_B^\infty(f|_{p^{-1}(b)}))} S$$

is the symmetric monoidal trace of the induced map $\Sigma^\infty((f|_{p^{-1}(b)})_+)$ on the fiber over b . Thus, just as in the previous examples, the symmetric monoidal fiberwise trace consists of all the traces on all the fibers, “put together” in a suitable way (here, in a way “continuously parametrized” by B).

As for the bicategorical trace, recall from Example 5.11 that the shadow of U_B is the suspension spectrum of the free loop space of B . Thus, Theorem 6.3 gives a factorization of the fiberwise trace as

$$\Sigma^\infty(B_+) \rightarrow \Sigma^\infty(LB_+) \rightarrow S.$$

The first map is induced by the inclusion of B into LB as constant loops. As for the second, a loop γ in B based at b induces an endomorphism E_γ of $p^{-1}(b)$, and the trace of $(\Sigma_+^\infty$ applied to) the composite

$$p^{-1}(b) \xrightarrow{E_\gamma} p^{-1}(b) \xrightarrow{f|_{p^{-1}(b)}} p^{-1}(b)$$

gives an endomorphism $S \rightarrow S$ of the sphere spectrum. Together, these maps comprise the bicategorical trace.

6.8. REMARK. As remarked previously, the unit object I_A of \mathcal{C}^A is always fiberwise dualizable. The symmetric monoidal trace of id_{I_A} is just itself, but its bicategorical trace is a nontrivial morphism $\langle\langle A \rangle\rangle \rightarrow I_\star$, which we can view as an “augmentation” of $\langle\langle A \rangle\rangle$. In §8 we will see that this augmentation plays an important role in comparing the two types of traces appropriate for total duality.

We would also like a version of Theorem 6.3 for twisted traces. There are various forms of this, depending on where we choose the twisting objects Q and P to live.

6.9. THEOREM. *Let $M \in \mathcal{C}^A$ be fiberwise dualizable.*

(i) *For any $Q \in \mathcal{C}^{A \times A}$, $P \in \mathcal{C}^\star$, and $g: Q \odot \widehat{M} \rightarrow \widehat{M} \odot P$, there is a corresponding morphism $\bar{g}: (\Delta_A)^*Q \otimes M \rightarrow M \otimes \pi_A^*P$ in \mathcal{C}^A , such that the bicategorical trace*

$$\text{tr}(g): (\pi_A)_!(\Delta_A)^*Q = \langle\langle Q \rangle\rangle \longrightarrow \langle\langle P \rangle\rangle = P$$

and the symmetric monoidal trace

$$\text{tr}(\bar{g}): (\Delta_A)^*Q \longrightarrow (\pi_A)^*P$$

are adjoints under the adjunction $(\pi_A)_! \dashv (\pi_A)^*$. In other words, the following triangles commute.

$$\begin{array}{ccc}
 (\pi_A)_!(\Delta_A)^*Q & \xrightarrow{\text{tr}(g)} & (\Delta_A)^*Q \longrightarrow (\pi_A)^*(\pi_A)_!(\Delta_A)^*Q \\
 (\pi_A)_! \text{tr}(\bar{g}) \downarrow & \searrow & \searrow \text{tr}(\bar{g}) \downarrow (\pi_A)^* \text{tr}(g) \\
 (\pi_A)_!(\pi_A)^*P & \longrightarrow & P \longrightarrow (\pi_A)^*P
 \end{array} \quad (6.10)$$

(ii) For any $Q, P \in \mathcal{C}^A$, and $f: Q \otimes M \rightarrow M \otimes P$, there is a corresponding morphism $\tilde{f}: (\Delta_A)_!Q \odot \widehat{M} \rightarrow \widehat{M} \odot (\pi_A)_!P$ such that the following triangle commutes.

$$\begin{array}{ccc}
 (\pi_A)_!Q & \longrightarrow & (\pi_A)_!(\Delta_A)^*(\Delta_A)_!Q \\
 & \searrow (\pi_A)_! \text{tr}(f) & \downarrow \text{tr}(\tilde{f}) \\
 & & (\pi_A)_!P
 \end{array} \quad (6.11)$$

(iii) For any $Q \in \mathcal{C}^A$ and $P \in \mathcal{C}^*$, there is a bijection between morphisms $f: Q \otimes M \rightarrow M \otimes (\pi_A)^*P$ and morphisms $\tilde{f}: (\Delta_A)_!Q \odot \widehat{M} \rightarrow \widehat{M} \odot P$, and for a corresponding pair of such morphisms, the following square commutes.

$$\begin{array}{ccc}
 (\pi_A)_!Q & \longrightarrow & (\pi_A)_!(\Delta_A)^*(\Delta_A)_!Q \\
 (\pi_A)_! \text{tr}(f) \downarrow & & \downarrow \text{tr}(\tilde{f}) \\
 (\pi_A)_!(\pi_A)^*P & \longrightarrow & P
 \end{array} \quad (6.12)$$

Note that g in (i) is of the maximally general form for a morphism of which we could take the bicategorical trace with respect to \widehat{M} . Thus, the conclusion of (i) says that for any bicategorical trace with respect to \widehat{M} , there is a symmetric monoidal trace with respect to M which carries exactly the same information.

By contrast, in (ii), f is of the maximally general form for a morphism of which we could take the symmetric monoidal trace with respect to M . Thus, the conclusion of (ii) says that for any symmetric monoidal trace with respect to M , there is a bicategorical trace with respect to \widehat{M} which is related to it in a suitable way.

Unlike the situation of (i), neither of these traces can be recovered from the other in general. However, if diagonals are monic, then the top map in (6.11) is an isomorphism, and thus the bicategorical trace $\text{tr}(\tilde{f})$ can be recovered from the symmetric monoidal trace $\text{tr}(f)$; hence the latter carries at least as much information as the former.

In the case of (iii), the lower-left composite

$$(\pi_A)_!Q \xrightarrow{(\pi_A)_! \text{tr}(f)} (\pi_A)_!(\pi_A)^*P \longrightarrow P$$

is the adjunct of $\text{tr}(f)$ under the adjunction $(\pi_A)_! \dashv (\pi_A)^*$, and thus carries exactly the same information. Therefore, in the situation of (iii), the bicategorical trace carries at

least as much information than the symmetric monoidal one. If diagonals are monic, then the top morphism in (6.12) is an isomorphism, and so the two traces carry exactly the same information.

Note that Theorem 6.3 is a special case of Theorem 6.9(iii), taking $Q = I_A$ and $P = I_*$; thus we only need to prove Theorems 6.1 and 6.9. In §11, we will do this using string diagram calculations.

6.13. EXAMPLE. Let A be a set and $F \in \mathbf{FinSet}^A$ be an A -indexed family of finite sets, and define $M(a) = \mathbb{Z}[F(a)]$. Then $M \in \mathbf{Ab}^A$ and is fiberwise dualizable, since each $M(a)$ is finitely generated and free. Moreover, we have a diagonal morphism

$$\Delta: M \rightarrow M \otimes M$$

induced by the diagonal $F \rightarrow F \times F$.

Now if $f: M \rightarrow M$ is any endomorphism, then the composite $\Delta \circ f: M \rightarrow M \otimes M$ is of the form assumed in Theorem 6.9(ii), with $Q = I_A$ and $P = M$. Its symmetric monoidal trace, of course, is the transfer of f in the symmetric monoidal category \mathbf{Ab}^A . This is a morphism $I_A \rightarrow M$, which simply picks out at each $a \in A$ the transfer of f_a , as in Example 4.8. The image of this under $(\pi_A)_!$ is a morphism $\mathbb{Z}[A] \rightarrow \bigoplus_{a \in A} M(a)$, which of course sends each generator $a \in A$ to the transfer of f_a . Since diagonals are monic in this case, the top morphism in (6.11) is an isomorphism, and so the bicategorical trace of \tilde{f} is exactly the same.

6.14. EXAMPLE. We can perform the same construction as in the previous example, but now starting with a *groupoid* A and a finite-set-valued functor $F \in \mathbf{FinSet}^A$. Again we obtain a fiberwise dualizable object M equipped with a diagonal, so we can apply Theorem 6.9(ii) to $\Delta \circ f$ for any $f: M \rightarrow M$. The symmetric monoidal transfer will, again, consist exactly of all the transfers of the fiber maps $f_a: M(a) \rightarrow M(a)$, and its image under $(\pi_A)_!$ will again be the sum of all of these.

Since $Q = I_A$, the domain $(\pi_A)_!(\Delta_A)^*(\Delta_A)_!Q$ of the bicategorical trace is isomorphic to $\langle\langle A \rangle\rangle$. Unsurprisingly, the bicategorical trace $\mathrm{tr}(\tilde{f}): \langle\langle A \rangle\rangle \rightarrow (\pi_A)_!M$ sends each conjugacy class $[\gamma]$ to the symmetric monoidal transfer of the composite

$$M(a) \xrightarrow{M(\gamma)} M(a) \xrightarrow{f_a} M(a)$$

thereby combining Examples 6.6 and 6.13.

7. Base change objects

In the previous section we stated our first comparison theorem for traces, with the proof deferred to §11. In §8 we will state and prove our second such theorem, but first we need to introduce some more structure implied by an indexed symmetric monoidal category.

Recall that we have equivalences $\mathcal{C}^A \simeq \mathcal{C}/\mathbf{S}(A, \star) \simeq \mathcal{C}/\mathbf{S}(\star, A)$. In fact, the action of the reindexing and indexed-coproduct functors is also visible in \mathcal{C}/\mathbf{S} , as follows. For any morphism $f: A \rightarrow B$ in \mathbf{S} , we define its **base change objects** to be

$$\begin{aligned} B_f &= (\mathrm{id}_B \times f)^* U_B & \text{and} \\ {}_f B &= (f \times \mathrm{id}_B)^* U_B, \end{aligned}$$

regarded as 1-cells $B \rightarrow A$ and $A \rightarrow B$ in \mathcal{C}/\mathbf{S} , respectively. Note that by the Beck-Chevalley condition from Figure 7(c) and its dual (and using the definition of U_B), we have isomorphisms

$$\begin{aligned} B_f &= (\mathrm{id} \times f)^* U_B \\ &= (\mathrm{id} \times f)^* (\Delta_B)_! \pi_B^*(U) \\ &\cong (f \times \mathrm{id})_! (\Delta_A)_! f^* \pi_B^*(U) \\ &\cong (f \times \mathrm{id})_! (\Delta_A)_! \pi_A^*(U) \\ &\cong (f \times \mathrm{id})_! U_A \end{aligned}$$

and ${}_f B \cong (\mathrm{id} \times f)_! U_A$. This equivalence for ${}_f B$ is shown using string diagrams in Figure 11 on page 630.

7.1. EXAMPLE. In the bicategory of spans in \mathbf{S} , the base change objects of a map $f: A \rightarrow B$ in \mathbf{S} are the spans $A \xleftarrow{\mathrm{id}} A \xrightarrow{f} B$ and $B \xleftarrow{f} A \xrightarrow{\mathrm{id}} A$.

7.2. EXAMPLE. In the bicategory of \mathbf{C} -valued matrices, the base change objects of a set-function $f: A \rightarrow B$ are the matrix

$$({}_f B)_{a,b} = \begin{cases} I & \text{if } b = f(a) \\ \emptyset & \text{otherwise} \end{cases}$$

and its transpose.

7.3. EXAMPLE. In the bicategory of \mathbf{C} -valued profunctors, the base change objects of a functor $f: A \rightarrow B$ are defined by

$$({}_f B)(a, b) = \mathrm{hom}_B(f(a), b) \cdot I \quad \text{and} \quad (B_f)(b, a) = \mathrm{hom}_B(b, f(a)) \cdot I$$

The purpose of introducing the base change objects is to prove the following lemma.

7.4. LEMMA. For any $f: A \rightarrow B$, $M \in \mathcal{C}^B$, and $N \in \mathcal{C}^A$, we have isomorphisms

$$\begin{aligned} \widehat{f^* M} &\cong {}_f B \odot \widehat{M} & \widehat{f_! N} &\cong B_f \odot \widehat{N} \\ \widetilde{f^* M} &\cong \widetilde{M} \odot B_f & \widetilde{f_! N} &\cong \widetilde{N} \odot {}_f B \end{aligned}$$

PROOF. The first isomorphism is the composite

$$\begin{aligned}
 \widehat{f^*M} &\cong f^*(\mathrm{id}_B \times \pi_B)_!(\Delta_B)_!(U \boxtimes M) \\
 &\cong (\mathrm{id}_A \times \pi_B)_!(f \times \mathrm{id}_B)^*(\Delta_B)_!(U \boxtimes M) \\
 &\cong (\mathrm{id}_A \times \pi_B)_!(f \times \mathrm{id}_B)^*(\Delta_B)_!(\Delta_B)^*(\pi_B \times \mathrm{id}_B)^*(U \boxtimes M) \\
 &\cong (\mathrm{id}_A \times \pi_B)_!(f \times \mathrm{id}_B)^*(\mathrm{id}_B \times \Delta_B)^*(\Delta_B \times \mathrm{id}_B)_!(\pi_B \times \mathrm{id}_B)^*(U \boxtimes M) \\
 &\cong (\mathrm{id}_A \times \pi_B)_!(\mathrm{id}_A \times \Delta_B)^*(f \times \mathrm{id}_B \times \mathrm{id}_B)^*(\Delta_B \times \mathrm{id}_B)_!(\pi_B \times \mathrm{id}_B)^*(U \boxtimes M) \\
 &\cong (\mathrm{id}_A \times \pi_B)_!(\mathrm{id}_A \times \Delta_B)^*(((f \times \mathrm{id}_B)^*(\Delta_B)_!\pi_B^*(U)) \boxtimes M) \\
 &\cong {}_fB \odot \widehat{M}.
 \end{aligned}$$

These isomorphisms come from the Frobenius axiom and the equality $(\pi \times \mathrm{id})\Delta = \mathrm{id}$. The other three are analogous. \blacksquare

The first isomorphism in Lemma 7.4 is shown using string diagrams in Figure 12 on page 630 (and the others are analogous). As usual, the string diagram version is considerably simpler.

7.5. REMARK. In particular, this means that the indexed category $\mathcal{C}: \mathbf{S}^{op} \rightarrow \mathcal{C}at$ is recoverable from the bicategory \mathcal{C}/\mathbf{S} together with the base change objects. If we recall from Remark 5.5 that \mathcal{C}/\mathbf{S} is actually a symmetric monoidal bicategory, then we can recover the monoidal structure of \mathcal{C} from it as well. The external product $\boxtimes: \mathcal{C}^A \times \mathcal{C}^B \rightarrow \mathcal{C}^{A \times B}$ can be identified with the functor

$$\boxtimes: \mathcal{C}/\mathbf{S}(A, \star) \times \mathcal{C}/\mathbf{S}(B, \star) \longrightarrow \mathcal{C}/\mathbf{S}(A \times B, \star)$$

arising from the monoidal structure of \mathcal{C}/\mathbf{S} .

In particular, since $M \otimes_A N \cong (\Delta_A)^*(M \boxtimes N)$, we also have

$$\widehat{M \otimes_A N} \cong_{\Delta}(A \times A) \odot (\widehat{M} \boxtimes \widehat{N}).$$

In the language of [6, 9], this means that \otimes_A is the “convolution monoidal structure” on $\mathcal{C}/\mathbf{S}(A, \star)$ induced by the “autonomous map pseudo-comonoid structure” of A arising from Δ . Under this identification, Theorem 6.1 becomes a special case of [9, Prop. 4.6]. (We are indebted to Daniel Sch appi for pointing out this connection.) It seems likely that versions of Theorems 6.3 and 6.9 are also true in that generality.

Essentially the same proof as of Lemma 7.4 shows that more generally, for any $f: A \rightarrow B$ and $M \in \mathcal{C}^{B \times C} \simeq \mathcal{C}/\mathbf{S}(B, C)$, we have ${}_fB \odot M \cong (f \times \mathrm{id})^*M$. In particular, if $M = {}_gC$ for some $g: B \rightarrow C$, we have

$${}_fB \odot {}_gC \cong (f \times \mathrm{id})^*({}_gC) \cong (f \times \mathrm{id})^*(g \times \mathrm{id})^*U_C \cong (gf \times \mathrm{id})^*U_C \cong {}_{gf}C.$$

It is easy to verify coherence of these isomorphisms, so that the assignment $f \mapsto {}_fB$ defines a pseudofunctor $\mathbf{S} \rightarrow \mathcal{C}/\mathbf{S}$ which is the identity on objects.

We can also conclude:

7.6. LEMMA. *For any $f: A \rightarrow B$ in \mathbf{S} , we have a dual pair $({}_fB, B_f)$.*

PROOF. The remarks above show that the functors ${}_fB \odot -$ and $B_f \odot -$ are naturally adjoint. The result then follows from the bicategorical Yoneda lemma. ■

Alternative proofs of Lemmas 7.4 and 7.6 can be found in [33], using the language of double categories. Together, they imply that \mathcal{C}/\mathbf{S} is a *proarrow equipment* in the sense of [41] (called a *framed bicategory* in [33]).

8. Total duality

In §6, we saw that duality in the symmetric monoidal category \mathcal{C}^A can be identified with a special case of duality in the bicategory \mathcal{C}/\mathbf{S} . However, even for objects of \mathcal{C}^A , the bicategory \mathcal{C}/\mathbf{S} introduces an additional, new type of duality: we can ask whether \widetilde{M} , rather than \widehat{M} , is right dualizable. In this case we say that M is **totally dualizable**.

In contrast to fiberwise duality, total duality does not take place entirely within \mathcal{C}^A , and thus can incorporate information about the object A as well. This is made precise by the following theorems, whose proofs are surprisingly easier than the corresponding ones in §6. (However, we will still need to postpone some computations to be done with string diagrams in §12.) The first theorem was proven by [22] in the case of parametrized spectra, and we give the same proof here.

8.1. THEOREM. *If $M \in \mathcal{C}^A$ is totally dualizable, then $(\pi_A)_!M$ is dualizable in \mathcal{C}^* .*

PROOF. By construction, the base change objects for $\pi_A: A \rightarrow \star$ can be identified with \widehat{I}_A and \widetilde{I}_A , and in particular we have a dual pair $(\widehat{I}_A, \widetilde{I}_A)$. Therefore, by Lemma 7.4 we have $(\pi_A)_!M \cong \widetilde{M} \odot \widehat{I}_A$. But since the composite of dual pairs is again a dual pair, if \widetilde{M} is right dualizable then so must $(\pi_A)_!M$ be, as a 1-cell $\star \rightarrow \star$. However, it is easy to verify that $\mathcal{C}/\mathbf{S}(\star, \star) \simeq \mathcal{C}^*$ as monoidal categories; thus $(\pi_A)_!M$ is dualizable in \mathcal{C}^* as desired. ■

In particular, for $M = I_A$ we have:

8.2. COROLLARY. *If $I_A \in \mathcal{C}^A$ is totally dualizable, then $\Sigma(A)$ is dualizable in \mathcal{C}^* .*

This is in sharp contrast to fiberwise duality, since I_A (being the unit object of a symmetric monoidal category) is always fiberwise dualizable. However, we will see later that objects $M \in \mathcal{C}^A$ other than I_A can be totally dualizable without implying any finiteness conditions on A .

The relationship between bicategorical and symmetric monoidal traces for totally dualizable objects is quite simple.

8.3. THEOREM. *If $M \in \mathcal{C}^A$ is totally dualizable and $f: M \rightarrow M$ is an endomorphism in \mathcal{C}^A , then the following triangle commutes.*

$$\begin{array}{ccc} I_\star & \xrightarrow{\text{tr}(\tilde{f})} & \langle\langle A \rangle\rangle \\ & \searrow & \downarrow \\ & \text{tr}((\pi_A)!f) & I_\star \end{array}$$

Here the right-hand vertical map is the augmentation of the shadow from Remark 6.8.

We will prove a more general version of this theorem momentarily, but first we consider some examples.

8.4. EXAMPLE. We have seen in Example 6.5 that an A -indexed family of abelian groups $M = (M_a)_{a \in A} \in \mathbf{Ab}^A$ is fiberwise dualizable just when each M_a is dualizable, which is to say, finitely generated and free. On the other hand, if M is totally dualizable, then Theorem 8.1 implies that $\bigoplus_a M_a$ must be dualizable, which implies that all but finitely many of the M_a must be zero and the rest must be dualizable.

In fact, this latter condition is also sufficient. For total dualizability of M means that there is an A -indexed family $(N_a)_{a \in A}$ and morphisms

$$\begin{aligned} \eta: U_\star &\longrightarrow \widetilde{M} \odot \widehat{N} \\ \varepsilon: \widehat{N} \odot \widetilde{M} &\longrightarrow U_A. \end{aligned}$$

satisfying appropriate triangle identities. Under the assumption that $\bigoplus_a M_a$ is dualizable, we may take $N_a = M_a^\star$ and define

$$\eta: \mathbb{Z} \longrightarrow \bigoplus_{a \in A} M_a \otimes N_a,$$

to be the sum of all the coevaluations of the M_a , and

$$\varepsilon: N_{a_1} \otimes M_{a_2} \longrightarrow \begin{cases} \mathbb{Z} & \text{if } a_1 = a_2 \\ 0 & \text{if } a_1 \neq a_2. \end{cases}$$

to be the evaluation of M_a if $a_1 = a_2$, and zero otherwise. The same approach works for a finite family of dualizable objects in any \mathbf{C} , as long as \mathbf{C} is additive so that we can add up the coevaluations.

Note that in particular, this means that the unit object I_A is totally dualizable if and only if A is finite. On the other hand, there can be totally dualizable objects in \mathbf{C}^A for arbitrarily large A , as long as their “support” is a finite subset of A .

Finally, if M is totally dualizable as above, and $f: M \rightarrow M$ is an endomorphism, then the trace of \tilde{f} is the induced map

$$\mathbb{Z} \xrightarrow{\sum_a \text{tr}(f_a)} \bigoplus_a \mathbb{Z}.$$

which is the direct sum of all the traces of the components f_a . The trace of $(\pi_A)_!f$ is the numerical sum of all these traces (as an endomorphism of \mathbb{Z}), and the augmentation $\langle\langle A \rangle\rangle = \bigoplus_a \mathbb{Z} \rightarrow \mathbb{Z}$ is “addition”. Thus, we can see that the bicategorical trace clearly carries more information than the symmetric monoidal one.

8.5. **EXAMPLE.** The finiteness restriction in the previous example arises because in an abelian group (or in a hom-set of any additive category) we can only add up finitely many elements. An example of a situation in which we can “add up” infinitely many elements is the monoidal category $\mathbf{C} = \mathbf{Sup}$ of *suplattices*, i.e. partially ordered sets with arbitrary suprema, and suprema-preserving maps. We think of the supremum of a subset of a suplattice as an infinitary version of the “sum” of that subset.

\mathbf{Sup} is a monoidal category, with a tensor product whose universal property says that it represents “bilinear maps”, i.e. functions that preserve suprema in each variable separately. The unit object is the two-element lattice. Many more suplattices than abelian groups are dualizable, precisely because we can “add up” infinitely many elements: for instance, any power set $\mathcal{P}(A)$ is dualizable as a suplattice. However, traces in \mathbf{Sup} carry correspondingly less information: there are only two maps $I \rightarrow I$, so a trace can only record the presence or absence of a “fixed point” rather than any numerical information.

The same sort of argument as above now shows that $M \in \mathbf{Sup}^A$ is totally dualizable just when each M_a is a dualizable suplattice, irrespective of the cardinality of A . (For the coevaluation, we take a pointwise supremum.) In particular, I_A is totally dualizable for *any* set A .

If $f: M \rightarrow M$ is an endomorphism of such an M , then the trace of \check{f} is the map

$$I \longrightarrow \coprod_a I \cong \mathcal{P}(A)$$

which picks out the subset of those $a \in A$ for which the trace of f_a is nonzero. Its composite with the augmentation $\mathcal{P}(A) \rightarrow I$ remembers only whether the trace of *any* f_a was nonzero.

8.6. **EXAMPLE.** Now we consider the underived example of groupoids and \mathbf{Ab} -valued profunctors. For simplicity, we also consider first the case of groups (one-object groupoids), in which case (as we remarked in Example 5.9) profunctors can be identified with bimodules between group rings. Thus, an object $M \in \mathbf{Ab}^G$ is totally dualizable just when it is right dualizable as a \mathbb{Z} - $\mathbb{Z}[G]$ -bimodule, which is equivalent to its being finitely generated and projective as a $\mathbb{Z}[G]$ -module.

In particular, $\mathbb{Z}[G]$ itself is always totally dualizable, regardless of how large G might be. On the other hand, the trivial module \mathbb{Z} , which is the unit object of \mathbf{Ab}^G , is quite rarely totally dualizable, since it is quite rarely projective. (But if we took $\mathbf{C} = \mathbf{Vect}_{\mathbb{Q}}$ to be the category of rational vector spaces instead of \mathbf{Ab} , then by Maschke’s theorem, the unit object \mathbb{Q} over any finite group G would be totally dualizable [40, 4.2.1, 4.2.2].)

Just as shadows of profunctors in this case can be identified with shadows of bimodules, the resulting traces for totally dualizable G -modules can be identified with the Hattori-Stallings trace (the trace in the bicategory of bimodules; see Example 5.1 and [29]). In

this case, Theorem 8.3 says that if $f: M \rightarrow M$ is an endomorphism with Hattori-Stallings trace $\text{tr}(\check{f}) \in \langle\langle \mathbb{Z}[G] \rangle\rangle$, and $\epsilon: \mathbb{Z}[G] \rightarrow \mathbb{Z}$ is the canonical augmentation of the group ring, then

$$\epsilon(\text{tr}(\check{f})) = \text{tr}(\epsilon_!(f))$$

(where $\epsilon_!$ denotes the “extension of scalars” functor along ϵ).

The case of arbitrary groupoids can be reduced to a combination of the case of groups, as just described, and the case of sets, as in Example 8.4. Namely, for a groupoid A , an object $M \in \mathbf{Ab}^A$ consists essentially of one module over each $\mathbb{Z}[G]$, as G runs through the isotropy groups of the connected components of A . Such an M is totally dualizable just when it is zero at all but finitely many connected components and totally dualizable at the others. As we have seen, the shadow of a groupoid is the direct sum (coproduct) of the shadows of the group rings of each of its isotropy groups:

$$\langle\langle A \rangle\rangle = \bigoplus_{x \in \pi_0(A)} \mathbb{Z}[\text{Conj}(\text{hom}_A(x, x))]$$

Finally, the trace of an endomorphism of a totally dualizable M is the direct sum of its traces at each connected component:

$$\text{tr}(f) = \sum_{x \in \pi_0(A)} \left(\text{tr}(f_x) \in \mathbb{Z}[\text{Conj}(\text{hom}_A(x, x))] \right) \in \langle\langle A \rangle\rangle$$

and Theorem 8.3 says that the sum in \mathbb{Z} of the augmentations of these traces is equal to the trace of the sum of the augmentations of f at each connected component:

$$\sum_{x \in \pi_0(A)} \epsilon(\text{tr}(f_x)) = \text{tr} \left(\sum_{x \in \pi_0(A)} \epsilon_!(f) \right) \in \mathbb{Z}.$$

8.7. EXAMPLE. The **Gpd**-indexed category of chain complexes up to homotopy is similar to that of **Gpd**-indexed abelian groups, but with some important differences. The principal one is that now a chain complex is dualizable if it is *quasi-isomorphic* to a finitely generated complex of projective modules. This makes for many more dualizable objects.

For instance, the unit object over a group G is totally dualizable just when \mathbb{Z} admits a finite projective resolution as a $\mathbb{Z}[G]$ -module. In this case the group G is said to be of *type FP*; see e.g. [3, VIII.6]. Groups of type FP include finitely generated free groups, surface groups, and finitely generated free abelian groups. All groups of type FP are torsion-free.

We can analyze the case of a general groupoid as we did in the previous example, by decomposing a profunctor into a direct sum of modules over group rings. However, for the purposes of computing an explicit example, it is instructive to proceed differently. Given any groupoid A and an object $x \in A$, we write $\mathbb{Z}[A_x]$ and $\mathbb{Z}[{}_x A]$ for the profunctors defined by

$$\mathbb{Z}[A_x](a) = \mathbb{Z}[\text{hom}_A(x, a)] \quad \text{and} \quad \mathbb{Z}[{}_x A](a) = \mathbb{Z}[\text{hom}_A(a, x)].$$

These are the base change objects, as in §7, associated to the functor $x: \star \rightarrow A$ which picks out the object x , relative to the **Gpd**-indexed symmetric monoidal category of families of abelian groups. (The corresponding base change objects for chain complexes are the same profunctors, regarded as concentrated in degree 0.)

In particular, therefore, $\mathbb{Z}[{}_x A]$ is right dualizable, with right dual $\mathbb{Z}[A_x]$. We regard $\mathbb{Z}[{}_x A]$ as the counterpart for groupoids of a rank-one free module. The main difference from the case of rings is that now, there may be more than one isomorphism class of such modules, if A has more than one isomorphism class of objects. Just as a map $R \rightarrow M$ from a rank-one free R -module to any R -module M is determined uniquely by an element of M (the image of $1 \in R$), a map $\mathbb{Z}[{}_x A] \rightarrow M$ of A -modules is determined uniquely by an element of $M(x)$ (the image of $\text{id}_x \in \text{hom}_A(x, x) \subseteq \mathbb{Z}[{}_x A](x)$). (This is essentially just the Yoneda Lemma.)

Now suppose that A is a *finitely generated free groupoid*, as in Example 4.7, with object set A_0 and generating set of morphisms A_1 , with source- and target-assigning maps $s, t: A_1 \rightrightarrows A_0$. Let $M \in \mathbf{Ab}^A$ be an A -indexed diagram of abelian groups such that each abelian group $M(x)$ is finitely generated and free. Write M_x for a basis of $M(x)$; then the action of any generator $\gamma \in A_1$ can be described by a “matrix” $\gamma_{M,p,q}$, with coefficients defined by

$$\gamma(p) = \sum_{q \in M_{t(\gamma)}} \gamma_{M,p,q} \cdot q$$

for $p \in M_{s(\gamma)}$. Then M is quasi-isomorphic to the following chain complex of A -modules concentrated in degrees 1 and 0:

$$\bigoplus_{\gamma \in A_1} \bigoplus_{p \in M_{s(\gamma)}} \mathbb{Z}[t(\gamma)A] \xrightarrow{d} \bigoplus_{x \in A_0} \bigoplus_{p \in M_x} \mathbb{Z}[{}_x A]. \tag{8.8}$$

Here the differential sends the generator $(\gamma, p, \text{id}_{t(\gamma)})$ of the (γ, p) summand to the difference

$$(s(\gamma), p, \gamma) - \sum_{q \in M_{t(\gamma)}} \gamma_{M,p,q} \cdot (t(\gamma), q, \text{id}_{t(\gamma)}).$$

In the case when A_0 has one object, so that A is a finitely generated free group, and M is the trivial module \mathbb{Z} , then the degree-0 part of this complex is just the group ring $\mathbb{Z}[G]$, and the degree-1 part is the *augmentation ideal*. In that case, at least, the fact that the augmentation ideal is also a finitely generated free module is well-known [40, 6.1.5].

Since this complex consists of finite sums of shifts of the dualizable objects $\mathbb{Z}[{}_x A]$, it is dualizable. Therefore, M is totally dualizable in the derived context of chain complexes, when regarded as a chain complex concentrated in degree 0. Its dual is the complex concentrated in degrees 0 and -1 :

$$\bigoplus_{x \in A_0} \bigoplus_{p \in M_x} \mathbb{Z}[A_x] \xrightarrow{\partial} \bigoplus_{\gamma \in A_1} \bigoplus_{p \in M_{s(\gamma)}} \mathbb{Z}[A_{t(\gamma)}]$$

(we leave the computation of the differential to the reader).

Now, if $f: M \rightarrow M$ is an endomorphism, with matrix elements $f_{p,q}$ defined by $f(p) = \sum_q f_{p,q} \cdot q$, then a corresponding endomorphism of (8.8) can be defined by

$$f(x, p, \text{id}_x) = \sum_q f_{p,q} \cdot (x, q, \text{id}_x)$$

$$f(\gamma, p, \text{id}_{t(\gamma)}) = \sum_q f_{p,q} \cdot (\gamma, q, \text{id}_{t(\gamma)}).$$

Therefore, noting that $\sum_{p \in M_x} f_{p,p}$ is the trace $\text{tr}(f_x)$ of f restricted to $M(x)$, we can calculate

$$\text{tr}(f) = \sum_{x \in A_0} \text{tr}(f_x) \cdot [\text{id}_x] - \sum_{\gamma \in A_1} \text{tr}(f_{t(\gamma)}) \cdot [\text{id}_{t(\gamma)}]$$

where each $[\text{id}_x]$ denotes the image of id_x in $\langle\langle A \rangle\rangle$. (As in Example 4.7, the minus sign arises from the symmetry isomorphism for the tensor product of chain complexes.)

Note that this result is invariant under equivalence of groupoids A , as it must be. In fact, it can be rephrased as a sum over the connected components of A :

$$\text{tr}(f) = \sum_{x \in \pi_0(A)} (1 - D_{A,x}) \text{tr}(f_x) \cdot [\text{id}_x]$$

where $D_{A,x}$ denotes the number of generators of the isotropy group of A at x (which is finitely generated and free).

Finally, since the augmentation $\langle\langle A \rangle\rangle \rightarrow \mathbb{Z}$ sends each $[\text{id}_x]$ to 1, Theorem 8.3 says that the trace of $(\pi_A)_!(f)$ must be

$$\sum_{x \in A_0} \text{tr}(f_x) - \sum_{\gamma \in A_1} \text{tr}(f_{t(\gamma)}) = \sum_{x \in \pi_0(A)} (1 - D_{A,x}) \text{tr}(f_x).$$

This is easy to verify directly, using the fact that since the homotopy colimit $(\pi_A)_!(M)$ can be calculated using the projective resolution (8.8) to be

$$\bigoplus_{\gamma \in A_1} \bigoplus_{p \in M_s(\gamma)} \mathbb{Z} \xrightarrow{d} \bigoplus_{x \in A_0} \bigoplus_{p \in M_x} \mathbb{Z}.$$

Note that if M is the constant functor at \mathbb{Z} , then this is exactly the chain complex representing $\Sigma(A)$ which we used in Examples 4.7 and 4.9.

8.9. EXAMPLE. Total duality was first studied in [22] for the derived bicategory of parametrized spectra, where it was called *Costenoble-Waner duality*; see also [29]. In this bicategory, Theorem 8.1 implies that if the parametrized sphere spectrum S_A over A is Costenoble-Waner dualizable, then $\Sigma^\infty(A_+)$ is dualizable. This is the original observation of [22] that Theorem 8.1 generalizes.

Concrete examples of Costenoble-Waner duality can also be found in [22]. For instance, the parametrized sphere spectrum S_A over any closed smooth manifold A is Costenoble-Waner dualizable [22, 18.6.1].

For simplicity, we consider only the trace of its identity map. The trace of the identity of $\Sigma^\infty(A_+)$ can be identified with the *Euler characteristic* of A (as an endomorphism of the sphere spectrum S). Thus, the theorem says that this Euler characteristic factors as

$$S \rightarrow \Sigma^\infty(LA_+) \rightarrow S.$$

The first map turns out to be the composite

$$S \rightarrow \Sigma^\infty(A_+) \rightarrow \Sigma^\infty(LA_+)$$

of the transfer of the identity map with the inclusion $A \rightarrow LA$ as constant paths.

While Theorem 8.3 is a direct analogue of Theorem 6.3, often we are interested in a different situation. As mentioned in the introduction, usually we are given a morphism in the cartesian monoidal base category \mathbf{S} , and we want to compute a trace which gives us information about its fixed points.

Our final theorem, which solves this problem, will be a version of Theorem 8.3 which compares twisted traces. Combined with the base change objects from §7, this will enable us to compare symmetric monoidal and total duality traces involving an endomorphism of the base object.

8.10. THEOREM. *Suppose $M \in \mathcal{C}^A$ is totally dualizable, $Q \in \mathcal{C}^*$, $P \in \mathcal{C}^{A \times A}$, and we have a morphism $f: Q \odot \widetilde{M} \rightarrow \widetilde{M} \odot P$. Suppose furthermore that we are given $R \in \mathcal{C}^*$ and a morphism*

$$\xi: P \odot \widehat{I}_A = (\text{id} \times \pi_A)_! P \longrightarrow (\pi_A)^* R = \widehat{I}_A \odot R.$$

Then the following triangle commutes:

$$\begin{array}{ccc} Q & \xrightarrow{\text{tr}(\tilde{f})} & \langle\langle P \rangle\rangle \\ & \searrow \text{tr}(\xi \circ f) & \downarrow \text{tr}(\xi) \\ & & R \end{array} \tag{8.11}$$

Here $\xi \circ f$ denotes the following composite in \mathcal{C}^* :

$$Q \otimes (\pi_A)_! M \cong Q \odot \widetilde{M} \odot \widehat{I}_A \xrightarrow{f \odot \text{id}} \widetilde{M} \odot P \odot \widehat{I}_A \xrightarrow{\text{id} \odot \xi} \widetilde{M} \odot \widehat{I}_A \odot R \cong (\pi_A)_! M \otimes R$$

PROOF. Continuing from the proof of Theorem 8.1, we observe that the equivalence $\mathcal{C}/\mathbf{S}(\star, \star) \simeq \mathcal{C}^*$ identifies the shadow of \mathcal{C}/\mathbf{S} (restricted to $\mathcal{C}/\mathbf{S}(\star, \star)$) with the identity functor of \mathcal{C}^* . Thus, this equivalence respects traces as well, and so the symmetric monoidal trace of $\xi \circ f$ can be identified with its bicategorical trace (considered as a morphism in $\mathcal{C}/\mathbf{S}(\star, \star)$). But with this identification, (8.11) simply becomes an instance of the functoriality of bicategorical trace [29, Prop. 7.5]. ■

As in the case of untwisted traces, we see that for total duality, bicategorical traces carry more information than the induced symmetric monoidal ones.

Probably the most important case of Theorem 8.10 is the following. Let $\phi: A \rightarrow A$ be an endomorphism of $A \in \mathbf{S}$, and let f be a morphism $M \rightarrow \phi^*M$. We think of such an f as a “ ϕ -equivariant endomorphism of M ”. Moreover, by Lemma 7.4 we can equivalently regard f as a morphism $\widetilde{M} \rightarrow \widetilde{M} \odot A_\phi$; thus its bicategorical trace will be a map $I_\star \rightarrow \langle\langle A_\phi \rangle\rangle$ in \mathcal{C}^\star .

We now want to apply Theorem 8.10 with $Q = R = I_\star$ and $P = A_\phi$. We choose ξ to be the morphism

$$A_\phi \odot \widehat{I}_A \xrightarrow{\cong} \widehat{\phi! I_A} \xrightarrow{\cong} \widehat{\phi! \phi^* I_A} \longrightarrow \widehat{I}_A.$$

The trace of this ξ is an augmentation $\langle\langle A_\phi \rangle\rangle \rightarrow I_\star$, which reduces to the augmentation of $\langle\langle A \rangle\rangle$ if ϕ is the identity. Theorem 8.10 then implies that $\text{tr}(\widetilde{f})$ factors $\text{tr}(\xi \circ f)$ via this augmentation.

Specializing even further, suppose that $M = I_A$ is totally dualizable; in this case we may say that A itself is “totally dualizable”. Then for any ϕ , we can choose f to be the isomorphism

$$I_A \cong \phi^* I_A. \tag{8.12}$$

The bicategorical trace of this f is a morphism $I_\star \rightarrow \langle\langle A_\phi \rangle\rangle$, which we call the **total-duality trace of ϕ** . In Proposition 12.5, we will prove that for this f and the above ξ , we have $\xi \circ f = \Sigma(\phi)$. Thus, we can deduce Theorem 1.2.

8.13. COROLLARY. *For any totally dualizable $A \in \mathbf{S}$ and any $\phi: A \rightarrow A$, the total-duality trace of ϕ is a morphism $I_\star \rightarrow \langle\langle A_\phi \rangle\rangle$ which factors the symmetric monoidal trace $\text{tr}(\Sigma(\phi)): I_\star \rightarrow I_\star$ via an augmentation $\langle\langle A_\phi \rangle\rangle \rightarrow I_\star$.*

In order to see what this means in examples, we need a way to compute the object $\langle\langle A_\phi \rangle\rangle$. We can do this with a generalization of the technique used for $\langle\langle A \rangle\rangle$ in §5 involving free loop spaces. Namely, suppose we have a homotopy pullback

$$\begin{array}{ccc} L_\phi A & \xrightarrow{p} & A \\ q \downarrow & & \downarrow (\text{id}, \phi) \\ A & \xrightarrow{\Delta} & A \times A. \end{array}$$

Then just as before, we have

$$\langle\langle A_\phi \rangle\rangle = (\pi_A)_!(\Delta_A)^*(\text{id}_A \times \phi)^*(\Delta_A)_! I_A \cong (\pi_A)_! p! q^* I_A \cong (\pi_{L_\phi A})_! I_{L_\phi A} = \Sigma(L_\phi A).$$

The actual pullback of Δ and (id, ϕ) is the equalizer of ϕ and the identity. Thus, in non-derived situations, $\langle\langle A_\phi \rangle\rangle$ is Σ applied to this equalizer.

8.14. **EXAMPLE.** Let A be a finite set, so that the unit object I_A in \mathbf{Ab}^A is totally dualizable, and let $\phi: A \rightarrow A$ be an endomorphism. Then the equalizer of ϕ and id is the set $\text{Fix}(\phi)$ of fixed points of ϕ , so that $\langle\langle A_\phi \rangle\rangle = \bigoplus_{\phi(a)=a} \mathbb{Z} = \mathbb{Z}[\text{Fix}(\phi)]$ is the free abelian group on this set. The augmentation $\langle\langle A_\phi \rangle\rangle \rightarrow \mathbb{Z}$ takes each basis element to 1. The total-duality trace of ϕ can then be computed as the homomorphism $\mathbb{Z} \rightarrow \langle\langle A_\phi \rangle\rangle$ which sends 1 to $\sum_{\phi(a)=a} a$. Thus, its image under the augmentation is the number of fixed points of ϕ , which is exactly the trace of $\xi \circ f = \Sigma(\phi)$.

In derived situations, however, $L_\phi A$ will generally be a “twisted free loop space” whose points are “paths” from a point x to $\phi(x)$.

8.15. **EXAMPLE.** For a groupoid A with an endofunctor ϕ , the pseudo-pullback of (id, ϕ) and Δ is the groupoid $L_\phi A$ whose points are pairs (x, γ) where $x \in A$ is an object and $\gamma \in \text{hom}_A(x, \phi(x))$ is a morphism. A morphism in $L_\phi A$ from (x, γ) to (y, δ) is a morphism $\alpha: x \rightarrow y$ in A such that an evident square commutes. Then $\langle\langle A_\phi \rangle\rangle$ is the colimit or homotopy quotient (depending on whether we are in the underived or derived setting) of the constant diagram on $L_\phi A$.

In the underived case of \mathbf{Ab} -valued profunctors, this implies that $\langle\langle A_\phi \rangle\rangle$ is the free abelian group on the set of connected components of $L_\phi A$. Using terminology from fixed-point theory, we may call the connected components of $L_\phi A$ the *fixed-point classes* of ϕ .

Similarly, in the derived case of $\mathbf{Ch}_{\mathbb{Z}}$ -valued profunctors, $\langle\langle A_\phi \rangle\rangle$ is the complex of chains on the nerve of $L_\phi A$. By a straightforward generalization of Example 5.13, we can identify the nerve of $L_\phi A$ with the “ ϕ -twisted cyclic nerve” of A . When A is a group G , the chains on its twisted cyclic nerve form the Hochschild complex of $\mathbb{Z}[G]_\phi$ as a bimodule over $\mathbb{Z}[G]$. As before, in the general case we obtain a direct sum over isotropy groups. Also as before, the derived-underived difference is not very important here, since the 0th homology of the derived version gives us back the underived version.

However, passing to the derived version *is* important in order to have nontrivial totally dualizable objects. As we saw in Examples 8.6 and 8.7, the unit object is rarely totally dualizable as an \mathbf{Ab} -valued profunctor, but as a $\mathbf{Ch}_{\mathbb{Z}}$ -valued profunctor in the derived case, it can sometimes be—for instance, when our groupoid is a group of type FP.

For a concrete example, let A be a finitely generated free groupoid, and let $\phi: A \rightarrow A$ be an endofunctor. As we saw in Example 8.7, the unit object I_A (i.e. the constant functor at \mathbb{Z}) is equivalent to the 2-term chain complex

$$\bigoplus_{\gamma \in A_1} \mathbb{Z}[t(\gamma)A] \xrightarrow{d} \bigoplus_{x \in A_0} \mathbb{Z}[xA].$$

Given $\phi: A \rightarrow A$, the twisted target $\phi^* I_A$ of (8.12) is represented by the same complex, but with the action of A twisted by ϕ . We can write this as

$$\bigoplus_{\gamma \in A_1} \mathbb{Z}[t(\gamma)A_\phi] \xrightarrow{d} \bigoplus_{x \in A_0} \mathbb{Z}[xA_\phi].$$

where for any object x , the profunctor $\mathbb{Z}[{}_xA_\phi]$ is defined by

$$\mathbb{Z}[{}_xA_\phi](y) = \mathbb{Z}[\text{hom}_A(\phi(y), x)].$$

Now the morphism (8.12) can be represented by the chain map

$$\begin{array}{ccc} \bigoplus_{\gamma \in A_1} \mathbb{Z}[t(\gamma)A] & \xrightarrow{d} & \bigoplus_{x \in A_0} \mathbb{Z}[{}_xA] \\ \downarrow & & \downarrow \\ \bigoplus_{\gamma \in A_1} \mathbb{Z}[t(\gamma)A_\phi] & \xrightarrow{d} & \bigoplus_{x \in A_0} \mathbb{Z}[{}_xA_\phi] \end{array}$$

defined as follows:

- Each degree-0 generator (x, id_x) goes to $(\phi(x), \text{id}_{\phi(x)})$.
- Suppose that γ is a generating morphism such that $\phi(\gamma)$ is written in terms of generators as

$$\phi(\gamma) = \alpha_n^{\epsilon_n} \cdots \alpha_1^{\epsilon_1},$$

with each $\epsilon_i \in \{+1, -1\}$. Then the degree-1 generator $(\gamma, \text{id}_{t(\gamma)})$ goes to the sum

$$\sum_{i=1}^n \epsilon_i \cdot (\alpha_i, \beta_i)$$

where $\beta_i \in \text{hom}_A(t(\gamma), t(\alpha_i))$ is defined by

$$\beta_i = \begin{cases} \alpha_{i+1}^{-\epsilon_{i+1}} \cdots \alpha_n^{-\epsilon_n} & \epsilon_i = 1 \\ \alpha_i \alpha_{i+1}^{-\epsilon_{i+1}} \cdots \alpha_n^{-\epsilon_n} & \epsilon_i = -1 \end{cases}$$

By our calculation of $\langle\langle A_\phi \rangle\rangle$, the total-duality trace of ϕ will be a sum of conjugacy classes of morphisms $[\delta]$ such that $\delta \in \text{hom}_A(\phi(x), x)$ for some x (note δ is not necessarily a generator). This can now be computed as a sum of the following terms:

- For every object x , if $\phi(x) = x$, then we have a contribution of $[\text{id}_x]$.
- For every generating morphism $\gamma: x \rightarrow y$, we have a contribution of

$$- \sum_{\alpha_i = \gamma} \epsilon_i \cdot [\beta_i]$$

with β_i defined as above.

The augmentation $\langle\langle A_\phi \rangle\rangle \rightarrow \mathbb{Z}$ takes each generator $[\delta]$ to 1, so applying it to this sum, we recover the trace as computed in Example 4.7.

8.16. **EXAMPLE.** Finally, this factorization is familiar in fixed point theory (the original context that we are working to generalize). Let B be a closed smooth manifold and $\phi: B \rightarrow B$ be an endomorphism. Then working in the derived indexed symmetric monoidal category of parametrized spectra, we have computed that $\langle\langle B_\phi \rangle\rangle$ is the suspension spectrum of the twisted loop space $\Lambda^\phi B = \{\gamma \in B^I \mid \phi(\gamma(0)) = \gamma(1)\}$. The augmentation is Σ_+^∞ applied to the map

$$\Lambda^\phi B \rightarrow *.$$

As remarked in Example 8.9, when B is a closed smooth manifold, its parametrized sphere spectrum S_B is totally dualizable. As usual, ϕ then induces a fiberwise morphism

$$f: S_B \rightarrow S_B \odot B_\phi,$$

whose bicategorical trace is a map $S \rightarrow \Sigma^\infty((\Lambda^\phi B)_+)$, hence an element of the 0th stable homotopy group of $(\Lambda^\phi B)_+$. However, this group is canonically isomorphic to $\mathbb{Z}[\pi_0(\Lambda^\phi B)]$, and $\pi_0(\Lambda^\phi B)$ is the set of *fixed-point classes* of the map ϕ . Thus, the trace of ϕ is equivalently a formal integral combination of fixed-point classes. Under this interpretation, it can be identified with the original definition of the *Reidemeister trace* from [4, 12], which assigns to each fixed-point class the sum of the indices of the fixed points in that class.

Acting on 0th stable homotopy, the augmentation takes each fixed-point class in $\pi_0(\Lambda^\phi B)$ to 1. Therefore, Corollary 8.13 reduces to the obvious fact that if we add up the Reidemeister coefficients over all fixed-point classes, we obtain the sum of the indices of *all* fixed points, i.e. the trace of $\Sigma^\infty(\phi_+)$.

Returning to the general situation, it is also natural to ask how the total-duality trace of ϕ is related to the *transfer* of $\Sigma(\phi)$, as defined in §4. We can compare these by applying Theorem 8.10 with a different choice of R and ξ . We take $R = \Sigma(A)$, of course, and we take ξ to be the following composite:

$$A_\phi \odot \widehat{I}_A \xrightarrow{\cong} \phi_! I_A \xrightarrow{\cong} \phi_! \phi^* I_A \longrightarrow I_A \longrightarrow (\pi_A)^*(\pi_A)_! I_A \xrightarrow{\cong} \widehat{I}_A \odot \Sigma(A)$$

which we denote by ζ . (Note that the previous ξ is a factor of this ζ .)

The trace of ζ is a morphism $\text{tr}(\zeta): \langle\langle A_\phi \rangle\rangle \rightarrow \Sigma(A)$, which factors the augmentation $\langle\langle A_\phi \rangle\rangle \rightarrow I_*$ through the augmentation $\Sigma(A) \rightarrow I_*$ (this follows from a triangle identity for the adjunction $(\pi_A)_! \dashv (\pi_A)^*$). If ϕ is the identity, so that $\langle\langle A_\phi \rangle\rangle = \langle\langle A \rangle\rangle$, then $\text{tr}(\zeta)$ is the retraction of the comparison map $\Sigma(A) \rightarrow \langle\langle A \rangle\rangle$. In Proposition 12.6 we will prove that $\zeta \circ f = \Sigma(\Delta \circ \phi)$. Thus, we obtain Theorem 1.3.

8.17. **COROLLARY.** *For any totally dualizable $A \in \mathbf{S}$ and any $\phi: A \rightarrow A$, the total-duality trace of ϕ factors the symmetric monoidal transfer $\text{tr}(\Sigma(\Delta \circ \phi)): I_* \rightarrow \Sigma(A)$ via the map $\text{tr}(\zeta): \langle\langle A_\phi \rangle\rangle \rightarrow \Sigma(A)$.*

Thus, not only does the total-duality trace carry more information than the symmetric monoidal trace, it also carries more information than the symmetric monoidal transfer.

8.18. **EXAMPLE.** As in Example 8.14, let $\phi: A \rightarrow A$ be an endomorphism of a finite set. Then $\Sigma(A) \cong \langle\langle A \rangle\rangle$ is the free abelian group with basis A , and the morphism $\langle\langle A_\phi \rangle\rangle \rightarrow \Sigma(A)$ maps the basis elements of $\langle\langle A_\phi \rangle\rangle$ (the fixed points of ϕ) to themselves. Thus, the total-duality trace $\sum_{\phi(a)=a} a \in \langle\langle A_\phi \rangle\rangle$ maps to the same sum $\sum_{\phi(a)=a} a \in \Sigma(A)$, which is the transfer $\text{tr}(\Delta \circ \phi)$.

8.19. **EXAMPLE.** As in Example 8.15, let $\phi: A \rightarrow A$ be an endomorphism of a finitely generated free groupoid, and recall from Example 4.9 that $\Sigma(A)$ is the free abelian group on the connected components of A . The morphism $\langle\langle A_\phi \rangle\rangle \rightarrow \Sigma(A)$ takes each conjugacy class $[\delta]$ to its connected component, and we see that the total-duality trace from Example 8.15 maps to the transfer from Example 4.9.

8.20. **EXAMPLE.** As noted before, the transfer of an endomorphism $\phi: M \rightarrow M$ of a closed smooth manifold is an element of $\mathbb{Z}[\pi_0(M)]$. The induced morphism $\pi_0(\Lambda^\phi M) \rightarrow \pi_0(M)$ associates a homotopy class of paths to the component containing it. Thus, the image in $\mathbb{Z}[\pi_0(M)]$ of the Reidemeister trace has the coefficient of a component in $\pi_0(M)$ being the sum of the fixed point indices of the fixed point classes lying in that component.

8.21. **REMARK.** The idea in the proof of Theorem 8.10 can be applied to more general traces in the bicategory \mathcal{C}/\mathbf{s} . Namely, suppose $M \in \mathcal{C}^{A \times B}$ is right dualizable, when regarded as a 1-cell $A \rightarrow B$ in \mathcal{C}/\mathbf{s} . Let $Q \in \mathcal{C}^{A \times A}$ and $P \in \mathcal{C}^{B \times B}$, and let $f: Q \odot M \rightarrow M \odot P$ be a morphism, which therefore has a trace $\text{tr}(f): \langle\langle Q \rangle\rangle \rightarrow \langle\langle P \rangle\rangle$. Suppose furthermore that as in Theorem 8.10, we have an $R \in \mathcal{C}^*$ and a morphism $\xi: P \odot \widehat{I}_A \rightarrow \widehat{I}_A \odot R$. Then by composition of dual pairs, $M \odot \widehat{I}_A \cong (\pi_B)_! M$ is right dualizable, and by the functoriality of bicategorical trace, the following triangle commutes:

$$\begin{array}{ccc} \langle\langle Q \rangle\rangle & \xrightarrow{\text{tr}(f)} & \langle\langle P \rangle\rangle \\ & \searrow \text{tr}(\xi \circ f) & \downarrow \text{tr}(\xi) \\ & & R. \end{array}$$

However, by Theorem 6.1, it follows that $(\pi_B)_! M$ is dualizable in the symmetric monoidal category \mathcal{C}^A , and $\xi \circ f$ is a morphism

$$Q \odot (\pi_B)_! M \rightarrow (\pi_B)_! M \odot R$$

of the sort to which we can apply Theorem 6.9(i). Therefore, there is a morphism

$$\overline{\xi \circ f}: (\Delta_A)^* Q \otimes_A (\pi_B)_! M \rightarrow (\pi_B)_! M \otimes_A (\pi_A)^* R$$

whose symmetric monoidal trace in \mathcal{C}^A carries the same information as $\text{tr}(\xi \circ f)$.

Thus, although it may seem that we have only considered two very special cases of duality and trace in \mathcal{C}/\mathbf{s} , the general case involves no new ideas, being essentially just a combination of these two.

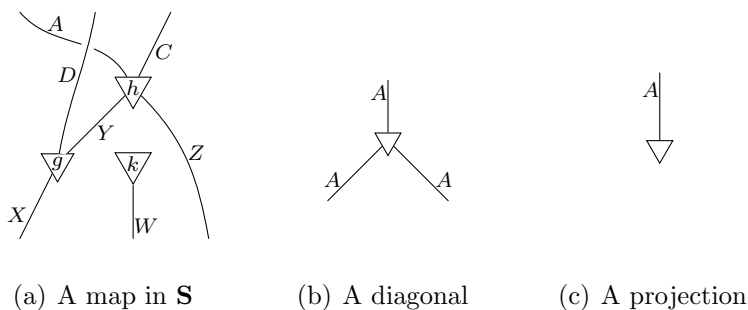

Figure 2: String diagrams in a cartesian monoidal base category

This concludes our results on refinements of the symmetric monoidal trace, and also the main part of the paper. In the subsequent sections, we introduce the string diagram calculus for indexed monoidal categories and apply it to complete the postponed proofs from §6 and §8.

9. String diagrams for objects

Our string diagram calculus for indexed monoidal categories is inherited from a similar calculus used by C. S. Peirce in his “System Beta.” This was given a categorical interpretation in terms of hyperdoctrines (indexed monoidal posets such as Examples 3.8 and 3.9) by [1].

We begin with the usual string diagram calculus for morphisms in the base category \mathbf{S} , drawn proceeding down the page, with the morphisms of \mathbf{S} contained in inverted triangles, as shown in Figure 2(a). Since the diagonal and projection maps $\Delta_A: A \rightarrow A \times A$ and $\pi_A: A \rightarrow \star$ play such an essential role, to reduce clutter we represent them by empty triangles, as in Figures 2(b) and 2(c).

To this string diagram calculus we now add a new type of vertex, which we draw as a square box. Such a vertex can only have strings coming in the top, never out the bottom, and if the strings entering its top are labeled by objects A, B, C of \mathbf{S} , then the box vertex must be labeled by an object of the fiber category $\mathcal{C}^{A \times B \times C}$. Finally, we require that our diagrams have no strings coming out the bottom either; all strings must end at a vertex of one type or the other. Thus we arrive at string diagrams such as in Figure 3(a).

One way to define the *value* of such a diagram is as follows: first we take the external product of all the fiber objects appearing (in box nodes), then we apply the reindexing functor f^* , where f is the composite of the \mathbf{S} -portion of the diagram. Thus, according to this scheme, the diagram in Figure 3(a) would have the value

$$(g \times h \times \text{id}_B)^*(M \boxtimes N).$$

However, there are other natural ways to “compose up” the same diagram, which for

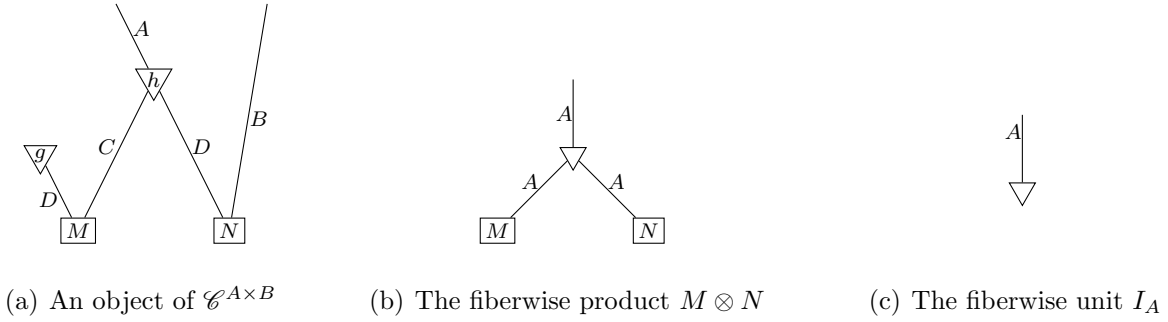

Figure 3: String diagrams in an indexed monoidal category

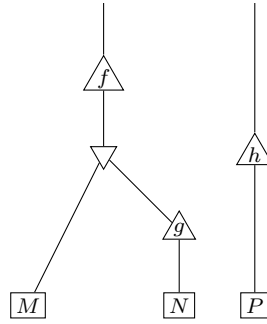

Figure 4: A string diagram involving indexed coproducts

Figure 3(a) give results such as

$$(h \times \text{id})^*(g \times \text{id})^*(M \boxtimes N) \quad \text{and}$$

$$(h \times \text{id})^*\left(\left((g \times \text{id})^*M\right) \boxtimes N\right).$$

The point of the string diagram notation is that all of these are canonically isomorphic (using the coherence isomorphisms for the monoidal structures and reindexing functors). A proper proof of validity for these string diagrams would make this precise, but we do not have space to give such a proof here. Thus, properly speaking our string diagrams are only an informal guide to the necessary calculations.

As a useful example, Figures 3(b) and 3(c) show string diagrams for the expressions (2.10) and (2.11), giving the fiberwise monoidal product and unit in terms of the external ones.

We now need a way to notate the adjoint functors $f_!$. We do this by introducing a third type of node, drawn with an upward-pointing triangle, which is also labeled by a morphism of \mathbf{S} but with the codomain on top and the domain on the bottom. For instance, the diagram in Figure 4 represents the object $(f_! \Delta^*(M \boxtimes g_! N)) \boxtimes h_! P$. The diagrams in Figures 5 and 6 are examples we have used earlier: Figure 5 is the bicategorical product, unit and shadow from Theorem 5.2, while Figure 6 is the functor Σ from §4.

Using this notation, the Beck-Chevalley conditions corresponding to the four pullback diagrams in Figure 1 on page 591 are shown in Figure 7 as isomorphisms between two

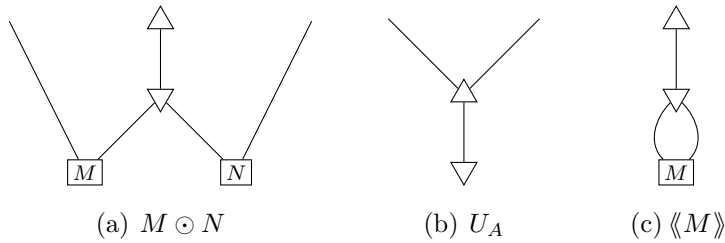

Figure 5: The operations of the bicategory \mathcal{C}/\mathbf{s}

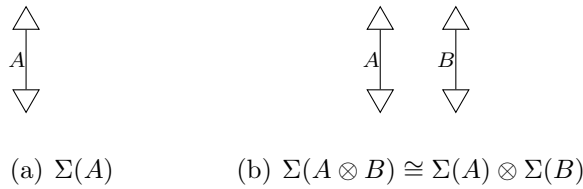

Figure 6: The functor Σ

(fragments of) string diagrams. In all cases, the natural morphism goes in the direction shown, and the content of the Beck-Chevalley condition is that this map is an isomorphism. The assumption that squares satisfying the Beck-Chevalley condition are closed under taking cartesian products with another fixed object implies that these morphisms are still invertible when they occur as fragments of larger diagrams. The transposes of Figures 1(b) and 1(c) are represented by the top-to-bottom reflections of Figures 7(b) and 7(c).

The isomorphism in Figure 7(a) is essential to our ability to make deformation-invariant sense of string diagrams involving f_i nodes. For this we also require that \otimes preserves indexed coproducts, in order that the diagram in Figure 8 have an unambiguous meaning.

As examples of reasoning using these diagrams, the associativity and unit isomorphisms of \mathcal{C}/\mathbf{s} are displayed graphically in Figure 9, while the shadow isomorphism $\langle\langle M \odot N \rangle\rangle \cong \langle\langle N \odot M \rangle\rangle$ is shown in Figure 10. In Figures 9(a) and 10, there are simple deformations connecting the two sides (using the symmetry of \mathbf{S} in the case of the shadow), which involve implicit applications of the “commutativity with reindexing” Beck-Chevalley condition. In Figure 9(b) we also need to use the “Frobenius” Beck-Chevalley condition. The coherence of these isomorphisms would follow from the “general validity” theorem for string diagrams which we have omitted.

Another important example is provided by base change objects. Figure 11 shows the string diagram definition of a base change object, while Figure 12 gives a graphical proof of Lemma 7.4, the interaction between base change object and the bicategory composition.

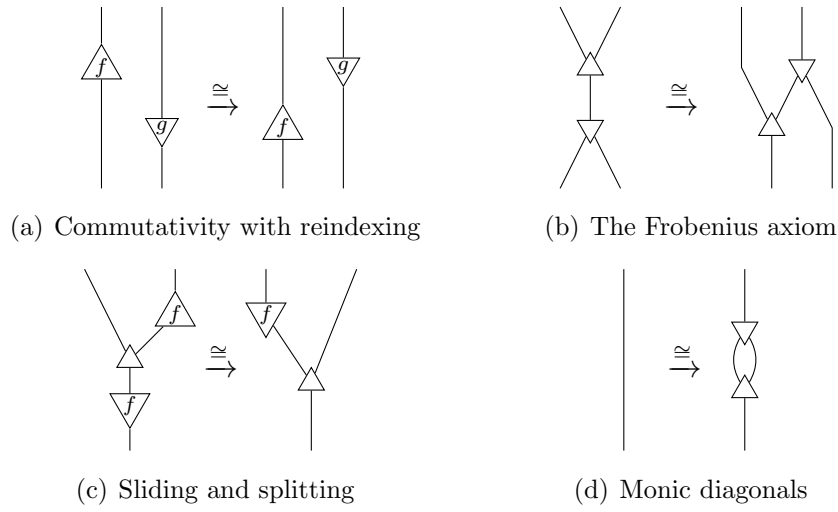

Figure 7: Beck-Chevalley conditions

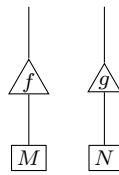
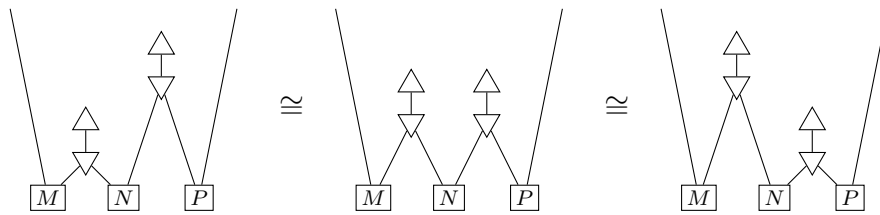
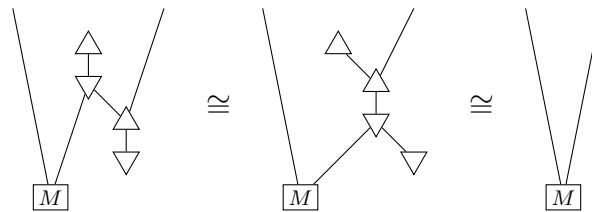

Figure 8: $(f \times g)_!(M \boxtimes N) \cong f_!M \boxtimes g_!N$



(a) Associativity



(b) Unitality

Figure 9: The constraints of the bicategory \mathcal{C}/\mathfrak{s}

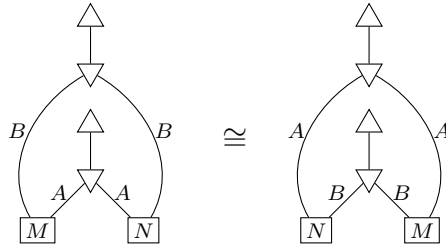

Figure 10: The shadow constraint of \mathcal{C}/\mathbf{s}

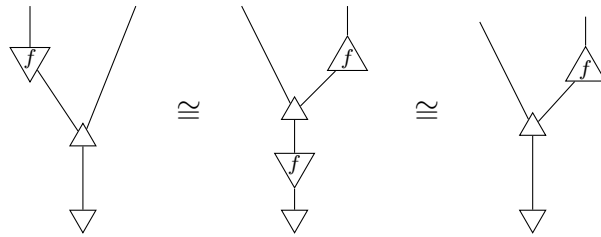

Figure 11: The base change object fB

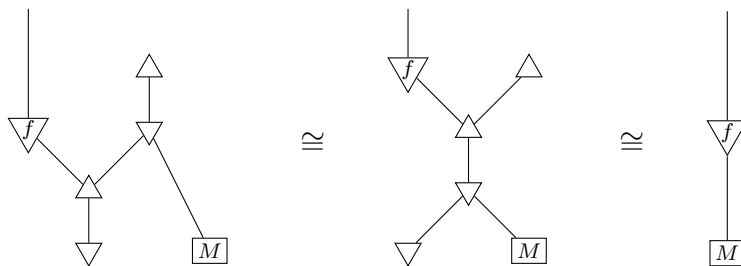

Figure 12: Proof of Lemma 7.4

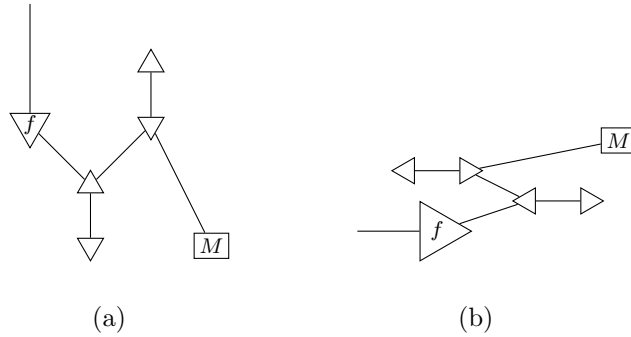

Figure 13: Transition to “slice diagrams”

10. String diagrams for morphisms

There is still something important missing from our string diagrams: morphisms in the fiber categories \mathcal{C}^A . (Here we go beyond [1], since in their posetal setting there were no morphisms to keep track of, only inequalities between objects.) Since we are representing the objects of \mathcal{C}^A by two-dimensional diagrams, we need three dimensions for morphisms between them.

We begin by rotating our string diagrams from the previous section to become horizontal slices, so that we can connect them with vertically drawn strings. For example, the string diagrams in Figures 13(a) and 13(b) represent the same object. Figure 13(a) gives a representation as in the previous section, while Figure 13(b) is the version we will use from now on. In these “slice” diagrams, the triangles for $f_!$ functors point to the left, in contrast with those for f^* functors which point to the right.

The morphisms will be represented by composites of “basic” morphisms, each of which is drawn as a node lying in between the corresponding slices, connected by strings to the nodes above and below which are its “direct” input and output. For other nodes which “do not participate” in the morphism, and thus appear identically above and below, we connect their incarnations in the upper and lower slices by a direct string. Just as with ordinary string diagrams, this allows us to see visually when two basic morphisms “do not interact” at all, and thus can be “slid past each other” by using a naturality property.

As an example, suppose we have morphisms $A \xrightarrow{f} B \xrightarrow{g} C$ in \mathbf{S} , along with a morphism $\phi: M \rightarrow N$ in \mathcal{C}^D . Then the following square commutes, by naturality of the pseudofunctor isomorphism $f^*g^* \cong (gf)^*$:

$$\begin{array}{ccc}
 f^*g^*M & \xrightarrow{\cong} & (gf)^*M \\
 f^*g^*\phi \downarrow & & \downarrow (gf)^*\phi \\
 f^*g^*N & \xrightarrow{\cong} & (gf)^*N.
 \end{array} \tag{10.1}$$

The equality of diagrams representing this commutative square is shown in Figure 14. Hopefully the reader can see the advantage of this over (10.1). To distinguish the strings

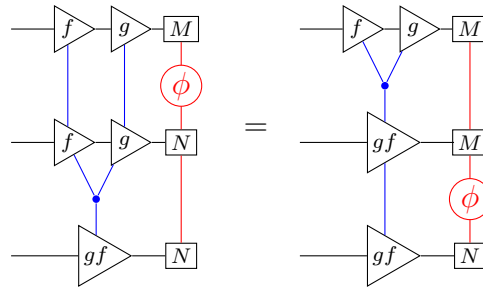
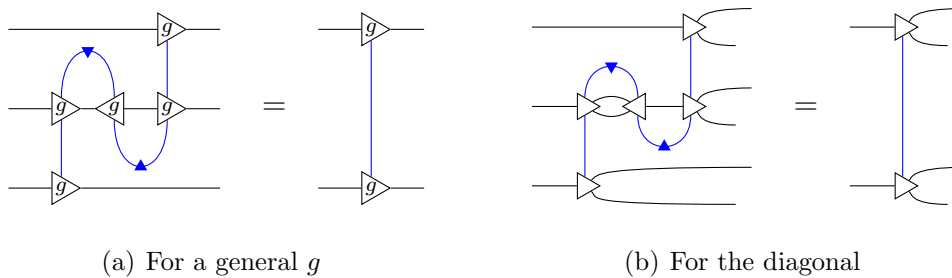

Figure 14: A slice diagram



(a) For a general g

(b) For the diagonal

Figure 15: Triangle identities for the adjunctions $g_l \dashv g^*$

in the slices from the strings that represent slice transitions, we draw the former with black lines and the latter with colored lines. For additional clarity, we further distinguish two different types of transition strings: those which connect to triangle vertices (which represent morphisms of \mathbf{S}) and those which connect to box vertices (which represent objects in fiber categories). We draw the former with blue lines and the latter with red lines.

The units and counits of the adjunctions $f_l \dashv f^*$ will frequently occur as basic morphisms in slice diagrams; we notate these with small blue triangles. As usual in string diagram notations, the triangle identities for these adjunctions look like simple topological deformations; some examples are shown in Figure 15.

In Figure 16 we further illustrate this notation by drawing the evaluation, coevaluation, and one triangle identity for a dual pair in a fiber category. (Recall that unlabeled triangles represent diagonal and projection morphisms.) We use small blue dots to represent the pseudofunctoriality isomorphisms of the indexed category; in Figure 16(c) the blue dots represent the isomorphisms

$$\begin{aligned} \Delta^*(\pi \times \text{id})^* &\cong \text{Id} \\ \Delta^*(\Delta \times \text{id})^* &\cong \Delta^*(\text{id} \times \Delta)^* \\ \Delta^*(\text{id} \times \pi)^* &\cong \text{Id}. \end{aligned}$$

Observe that the red strings connecting the box nodes in Figure 16(c) display the same shape as the usual representation of a triangle identity in a monoidal category.

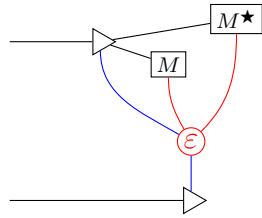

(a) The evaluation

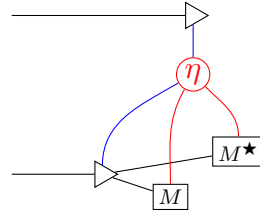

(b) The coevaluation

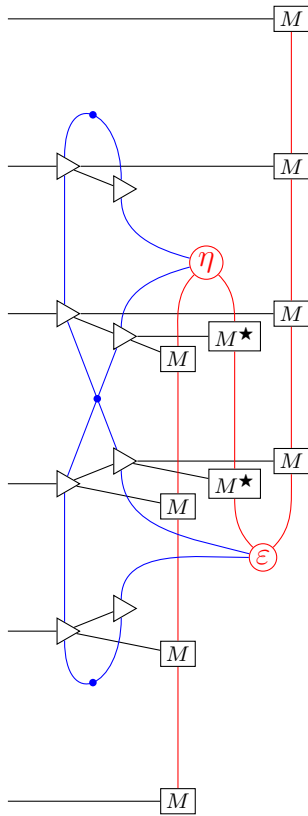

(c) A triangle identity

$$\begin{array}{c}
 M \\
 \downarrow \cong \\
 \Delta^*(\pi^*U \boxtimes M) \\
 \downarrow \Delta^*(\eta \boxtimes \text{id}) \\
 \Delta^*(\Delta^*(M \boxtimes M^*) \boxtimes M) \\
 \downarrow \cong \\
 \Delta^*(M \boxtimes \Delta^*(M^* \boxtimes M)) \\
 \downarrow \Delta^*(\text{id} \boxtimes \varepsilon) \\
 \Delta^*(M \boxtimes \pi^*U) \\
 \downarrow \cong \\
 M
 \end{array}
 = \text{id}_M$$

Figure 16: A dual pair in a fiber category

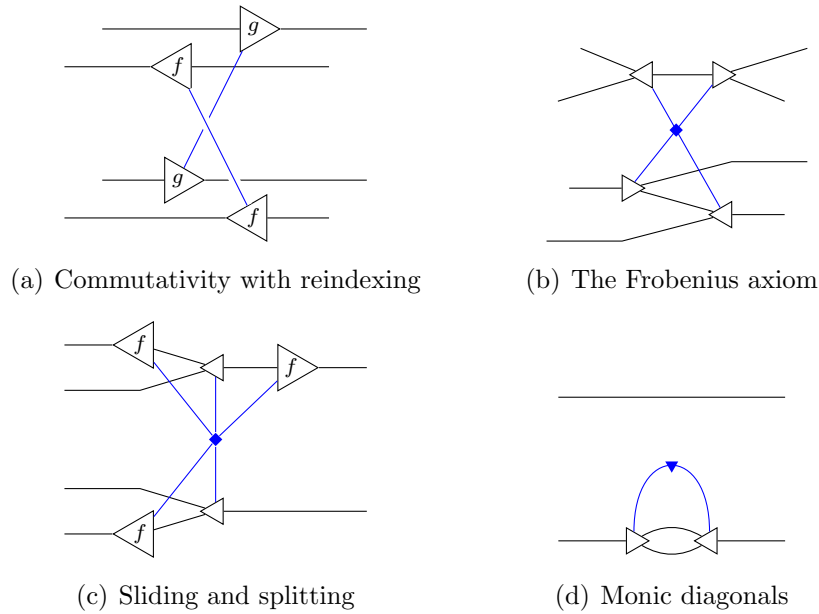

Figure 17: Surfaces for Beck-Chevalley conditions

The Beck-Chevalley conditions corresponding to the four pullback diagrams in Figure 1, and which were shown in Figure 7 as isomorphisms between two (fragments of) string diagrams, are displayed in Figure 17 as morphisms between slices. The transposes of Figures 1(b) and 1(c) are represented by the left-to-right reflections of Figures 17(b) and 17(c), respectively.

In Figure 17(a) we draw the Beck-Chevalley morphism simply as one blue string crossing in front of another, since it represents merely a deformation of the slice diagrams. In Figure 17(d) we denote the Beck-Chevalley morphism with a triangle, since it can be identified with the unit of the adjunction $\Delta_! \dashv \Delta^*$. Finally, for the Beck-Chevalley morphisms in Figures 17(b) and 17(c), and their inverses when these occur, we use a small blue diamond. The isomorphisms in Figures 17(b), 17(c), and 17(d), however, are less “topological” than that in Figure 17(a) (although Figure 17(b) becomes a topological deformation if we replace our strings by *tubes*, as is well-known in the context of Topological Quantum Field Theory).

We end this section with an important computation that will be used many times in the following sections. First of all, since the composite $A \xrightarrow{\Delta_A} A \times A \xrightarrow{\pi_A \times \text{id}_A} A$ is the identity id_A , we have

$$(\Delta_A)^*(\pi_A \times \text{id}_A)^* \cong \text{Id} \quad \text{and} \quad (\pi_A \times \text{id}_A)_!(\Delta_A)_! \cong \text{Id}. \quad (10.2)$$

These isomorphisms already appeared in Figure 16(c); in Figure 18(a) we isolate them.

Secondly, we can say more: the adjunction $(\pi_A \times \text{id}_A)_!(\Delta_A)_! \dashv (\Delta_A)^*(\pi_A \times \text{id}_A)^*$ is isomorphic to the identity adjunction. In particular, its unit

$$\text{Id} \longrightarrow (\Delta_A)^*(\Delta_A)_! \longrightarrow (\Delta_A)^*(\pi_A \times \text{id}_A)^*(\pi_A \times \text{id}_A)_!(\Delta_A)_!$$

is equal to the composite of the inverses of the isomorphisms (10.2). Graphically, this implies that the “blob” in Figure 18(b) is equal to the identity. We obtain Figure 18(c), which we call a *curlycue identity*, by moving one of the isomorphisms (10.2) to the other side.

Finally, in Figure 18(d), we go from the first diagram to the second by adding a triangle identity for the adjunction $\Delta_! \dashv \Delta^*$ at the top and sliding the counit down to the bottom, then to the third diagram by applying the curlycue identity. We will refer to the equality of the first and third diagrams in Figure 18(d) as a *broken zigzag identity*.

10.3. REMARK. We have remarked that the Beck-Chevalley morphism for the non-homotopy-pullback square in Figure 1(d) is simply the unit $\text{Id} \rightarrow (\Delta_A)^*(\Delta_A)_!$ of the adjunction $(\Delta_A)_! \dashv (\Delta_A)^*$. Thus, the fact that Figure 18(b) is the identity means that regardless of whether the Beck-Chevalley condition holds, this morphism is always split monic; the lower 2/3 of Figure 18(b) supplies a retraction. (We would obtain a different retraction, however, by using $\text{id} \times \pi$ instead of $\pi \times \text{id}$.)

10.4. REMARK. There are other ways to depict the adding of a dimension to string diagrams. Rather than using a new type of string as we have done, a more usual approach would be to keep the codimension of all elements constant as we move up in dimension. Thus, we would replace the strings and nodes occurring in the two-dimensional slice diagrams by surfaces and strings, respectively, and then use 0-dimensional nodes for the morphisms in the fiber categories.

Arguably, using surfaces is the “correct” representation, and our “slice” diagrams can in fact be viewed as slices *of* surfaces. The strings and nodes in the slices are slices of surfaces and strings, while the vertically drawn strings are actual strings in the surface diagram (singular junctions of surfaces) and the nodes along them are actual nodes. The reader is welcome to interpret our diagrams in this way. One advantage of this viewpoint is that then pictures such as those in Figure 15(b) are related by a simple topological deformation. Moreover, if we view the an indexed monoidal category as sitting inside the bicategory constructed from it, as suggested in Remark 7.5, then such surface diagrams can be regarded as a fragment of the more traditional surface diagrams for monoidal bicategories. (Our string diagrams are in fact an adaptation of a “schematic” or “hybrid” sort of surface diagram for monoidal bicategories that was suggested to us by Daniel Sch appi.)

However, the authors find it quite difficult to draw and visualize even moderately complicated surface diagrams—whereas we can easily manipulate our “slice-transition” diagrams schematically, without attempting to figure out what sort of “surfaces” they represent.

11. Proofs for fiberwise duality and trace

In this section we will prove Theorems 6.1 and 6.9, using string diagram calculations.

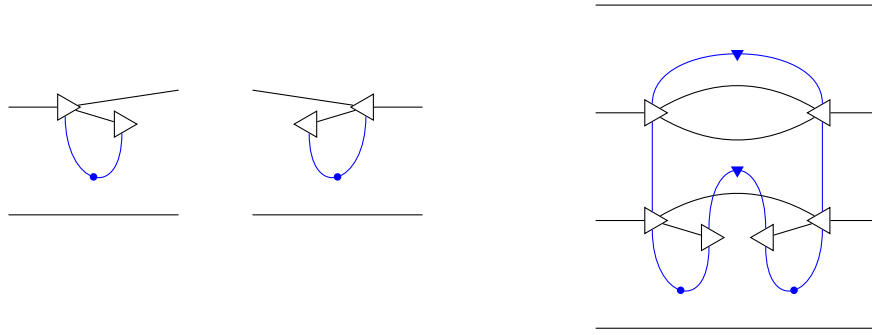

(a) The isomorphisms (10.2)

(b) The blob

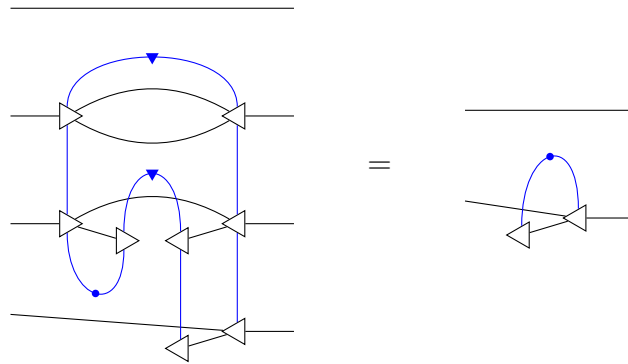

(c) Straightening out a curlycue

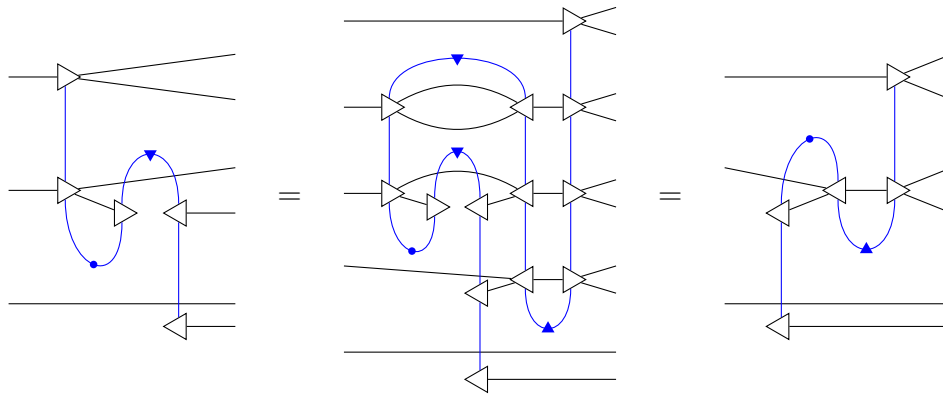

(d) The broken zigzag

Figure 18: Blobs, curlycues, and broken zigzags

PROOF OF THEOREM 6.1 For \widehat{M} to be right dualizable, we require a 1-cell $(\widehat{M})^\star : 1 \rightarrow A$, which of course is of the form \check{N} for some $N \in \mathcal{C}^A$, and morphisms

$$\begin{aligned} \bar{\eta} : U_A &\longrightarrow \widehat{M} \odot \check{N} \\ \bar{\varepsilon} : \check{N} \odot \widehat{M} &\longrightarrow U_\star \end{aligned}$$

satisfying the triangle identities. Substituting in the definitions of the structure of \mathcal{C}/\mathfrak{s} , we can rewrite such maps as

$$\begin{aligned} \bar{\eta} : (\Delta_A)!I_A &\longrightarrow \pi_1^*M \otimes \pi_2^*N \\ \bar{\varepsilon} : (\pi_A)!(M \otimes N) &\longrightarrow I_\star. \end{aligned}$$

These morphisms are depicted in Figures 19(a) and 19(b).

However, giving such maps is equivalent to giving their adjuncts

$$\begin{aligned} \eta : I_A &\longrightarrow \Delta_A^*(\pi_1^*M \otimes \pi_2^*N) \xrightarrow{\cong} \Delta_A^*\pi_1^*M \otimes \Delta_A^*\pi_2^*N \xrightarrow{\cong} M \otimes N \\ \varepsilon : (M \otimes N) &\longrightarrow (\pi_A)^*I_\star \xrightarrow{\cong} I_A \end{aligned}$$

and these are exactly the maps required to make N into a dual of M in \mathcal{C}^A , as shown in Figures 16(a) and 16(b). This gives us a bijection between putative evaluation-coevaluation morphisms for dual pairs (M, N) and (\widehat{M}, \check{N}) . In Figures 19(c), 19(d), 19(e), and 19(f), we show explicitly how this bijection works.

Thus, it remains only to verify that $\bar{\eta}$ and $\bar{\varepsilon}$ satisfy the appropriate triangle identities if and only if η and ε satisfy *their* triangle identities. We will verify this for one triangle identity; the other is similar and left to the reader. Refer to Figures 20 and 21.

In Figure 20(a) we show the composite which the bicategorical triangle identity asserts to be equal to an identity. The morphisms occurring at the top prior to the coevaluation $\bar{\eta}$ comprise the isomorphism from Figure 9(b) (spelled out in more detail), using the definition of the Beck-Chevalley morphism from Figure 7(d). In Figure 20(b) we have replaced $\bar{\eta}$ and $\bar{\varepsilon}$ with their equivalents in terms of the symmetric monoidal η and ε . Then in Figure 20(c), we slide a number of morphisms past each other, in the way which string diagram notation makes easy to see. To get to Figure 21(a), we apply a triangle identity for the adjunction $\Delta_! \dashv \Delta^*$, as in Figure 15(b). In Figure 21(b) we do some more sliding, and then finally in Figure 21(c) we apply (the dual of) the curlycue identity from Figure 18(c). But Figure 21(c) is exactly the composite which the symmetric monoidal triangle identity asserts equal to an identity. Thus, one triangle identity holds if and only if the other does. ■

PROOF OF Theorem 6.9(i) The definition of \bar{g} is shown in Figure 22(a). We must show that the bicategorical trace

$$\text{tr}(g) : (\pi_A)!(\Delta_A)^*Q = \langle\langle Q \rangle\rangle \longrightarrow \langle\langle P \rangle\rangle = P$$

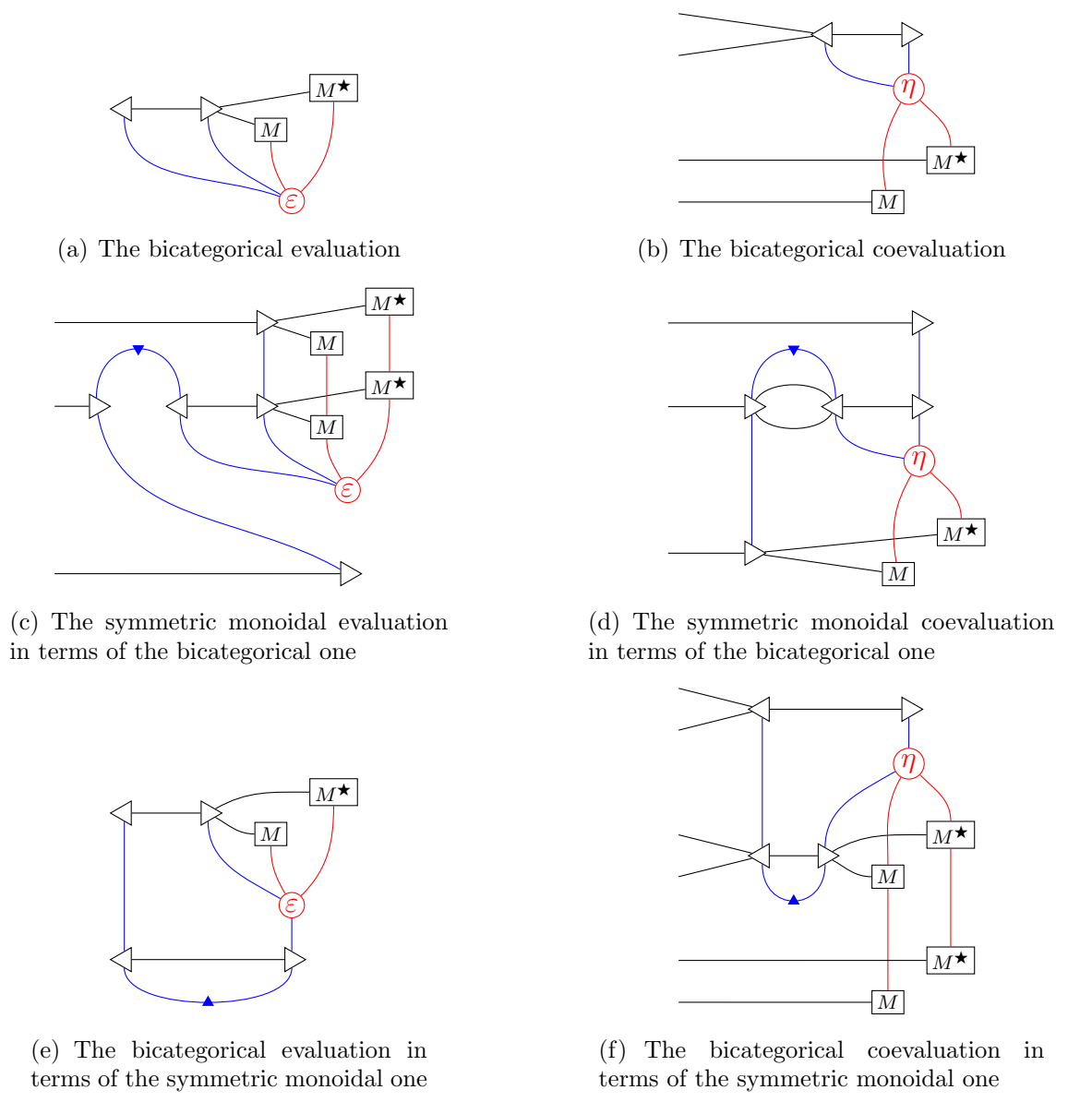

Figure 19: The correspondence between symmetric monoidal and bicategorical evaluation and coevaluation

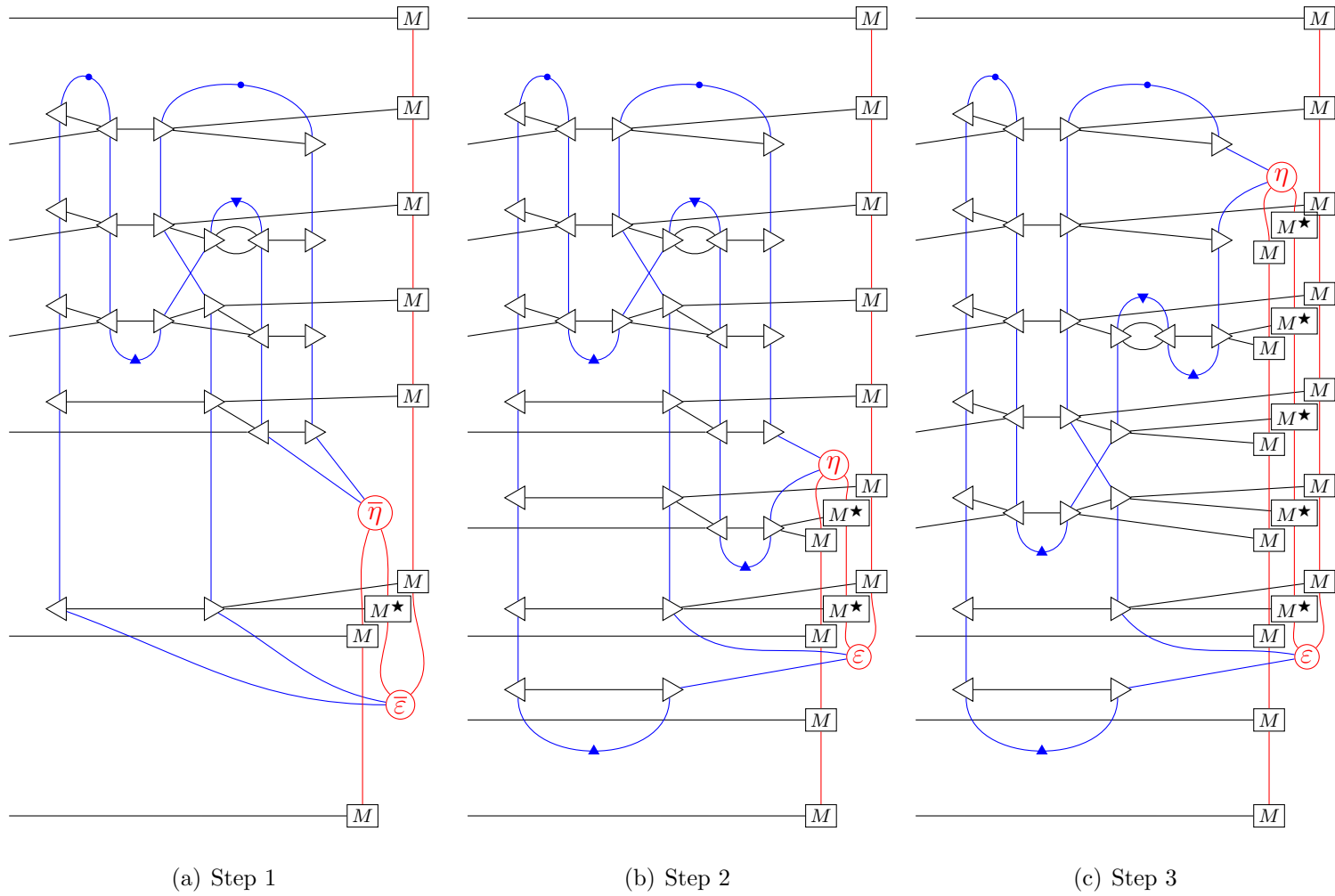

Figure 20: Comparison of fiberwise duals, steps 1–3

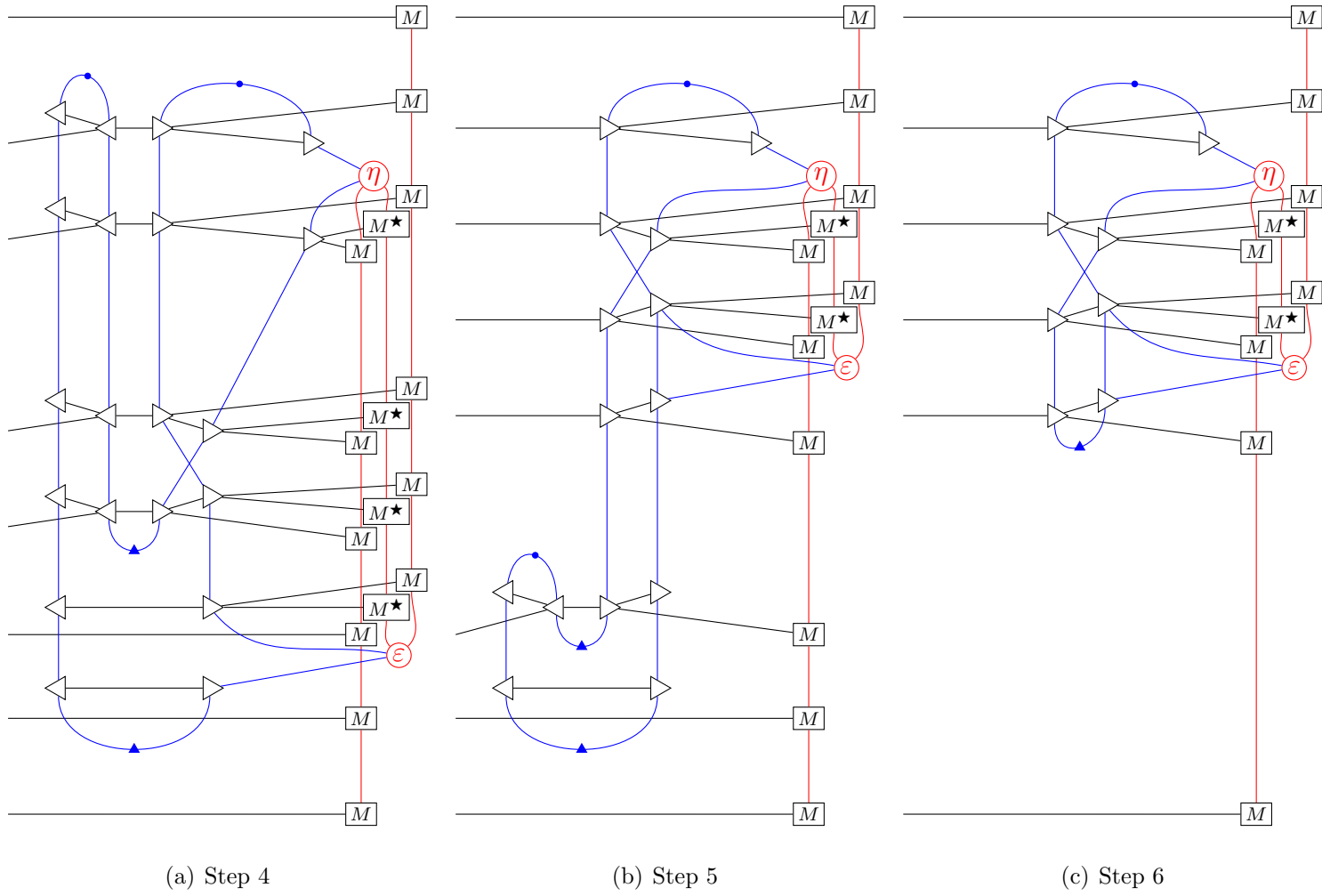

Figure 21: Comparison of fiberwise duals, steps 4–6

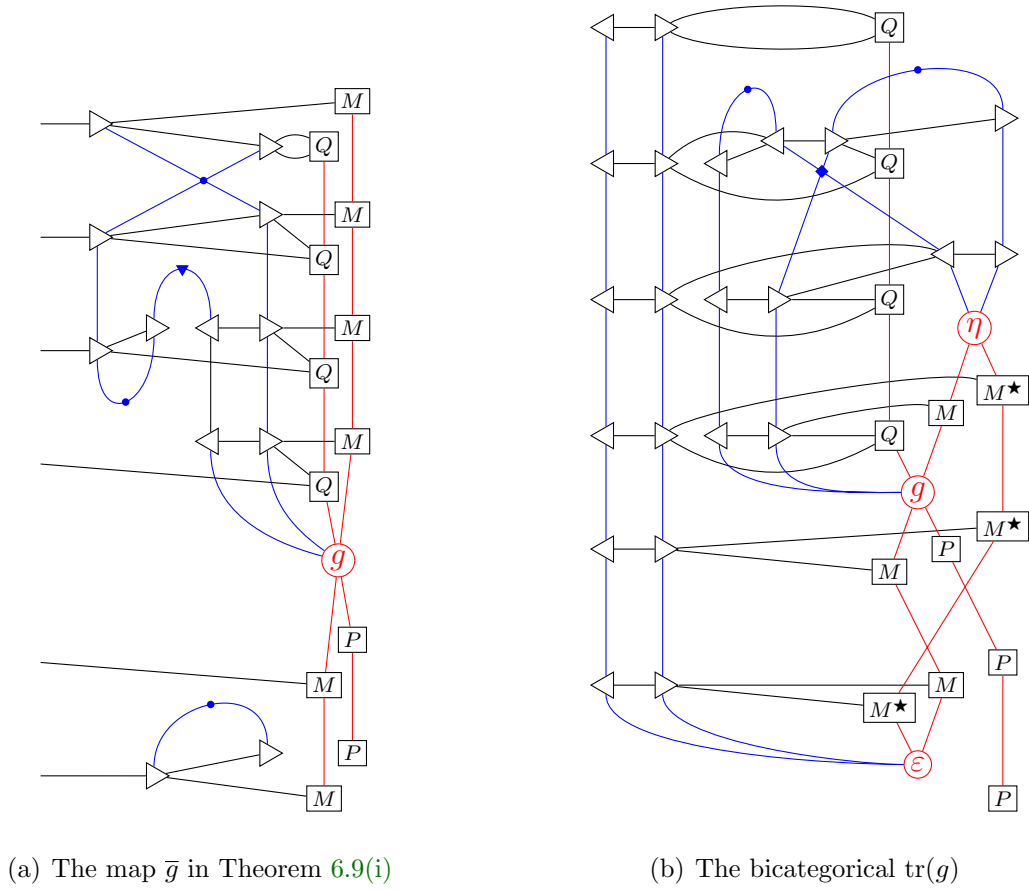

Figure 22: Two morphisms from the proof of Theorem 6.9(i)

is equal to the composite

$$(\pi_A)_!(\Delta_A)^*Q \xrightarrow{(\pi_A)_! \text{tr}(\bar{g})} (\pi_A)_!\pi_A^*P \longrightarrow P. \tag{11.1}$$

In Figure 22(b) we show $\text{tr}(g)$, while in Figure 23 we show (11.1) with the definition of \bar{g} substituted. We can first of all consider the parts of these diagrams occurring above g separately from those occurring below g ; it will clearly suffice to show that each of these pairs are equal.

In Figure 24 we treat the lower parts. Figure 24(a) is the lower part of Figure 23. To obtain Figure 24(b), we change the isomorphism

$$\Delta^*(\text{id} \times \pi^*)\pi^* \cong \pi^*$$

from one which contracts Δ with the second π to one which contracts it with the first. The two are equal by pseudofunctor coherence, since both are induced by the equality $\pi(\text{id} \times \pi)\Delta = \pi$.

Then in Figure 24(c) we slide ε and the symmetry down to the bottom. This yields the lower part of Figure 22(b) (recalling the relationship of the symmetric monoidal and bicategorical evaluations) together with a composite of pseudofunctoriality isomorphisms on top. But by pseudofunctor coherence, this composite is equal to the identity.

Next, in Figure 25 we begin considering the upper parts. In Figure 25(a) we show the upper part of Figure 23, with the symmetric monoidal coevaluation written in terms of the bicategorical one. Then in Figure 25(b) we slide the bicategorical η all the way to the bottom (directly above g , which divides the upper from the lower parts).

Since η also occurs directly above g in Figure 22(b), it suffices to compare the parts of Figures 22(b) and 25(b) occurring above η . Moreover, we may also ignore the Q node and the $(\pi_A)_!$ node on the far left, since neither plays any role in either of these diagrams.

Now, in Figure 26(a) we have copied the part of Figure 22(b) above η , with Q and $(\pi_A)_!$ omitted and the definition of the Frobenius morphism substituted. In Figure 26(b) we simply slide, and then to get to Figure 26(c) we apply the broken zigzag identity (Figure 18(d)).

In Figure 27(a) we replace the isomorphism at the very top by a composite of two other isomorphisms, which is equal to it by pseudofunctor coherence. Figure 27(b) is a simple slide, and then in Figure 27(c) we replace the composite of two associativity isomorphisms by the composite of three (the ‘‘pentagon identity,’’ which also holds by pseudofunctor coherence).

In Figure 28(a) we slide the lower of these associativities past a unit, and finally in Figure 28(b) we compose two isomorphisms at the bottom to obtain a different one (again by pseudofunctor coherence). The result is exactly the part of Figure 25(b) above η , with Q and $(\pi_A)_!$ omitted. ■

PROOF OF Theorem 6.9(ii) We define \tilde{f} to be the composite

$$(\Delta_A)_!Q \odot \widehat{M} \xrightarrow{\cong} Q \otimes M \xrightarrow{f} M \otimes P \rightarrow M \otimes (\pi_A)^*(\pi_A)_!P \xrightarrow{\cong} \widehat{M} \odot (\pi_A)_!P.$$

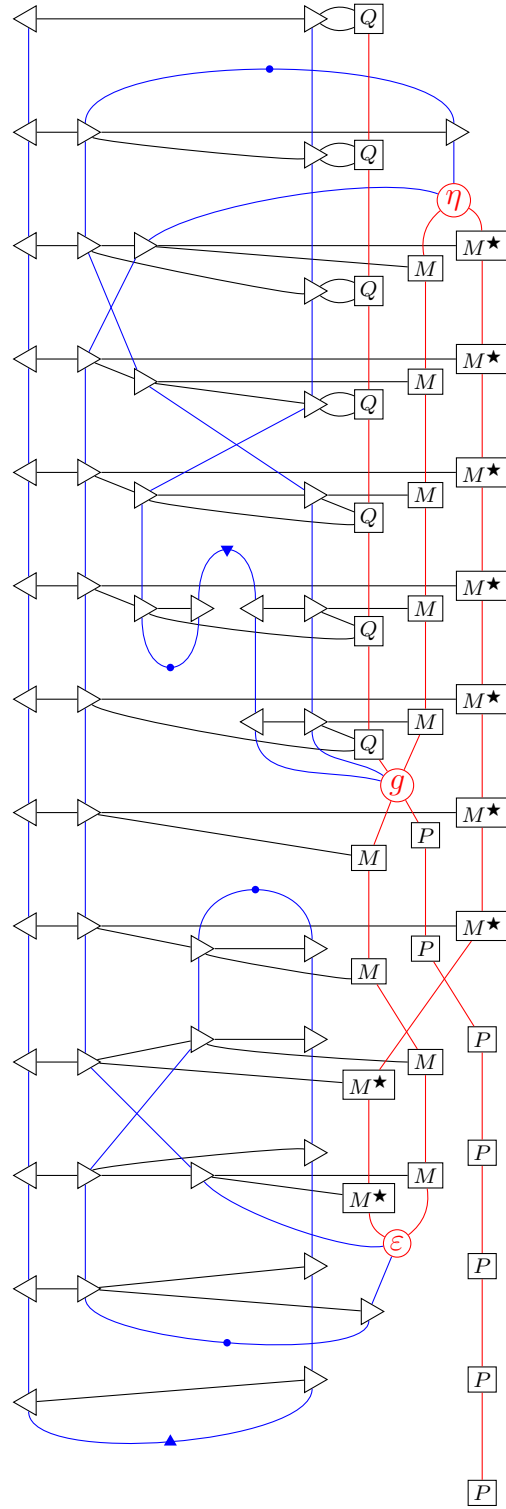

Figure 23: The symmetric monoidal $\epsilon \circ (\pi_1)_! \text{tr}(\bar{g})$

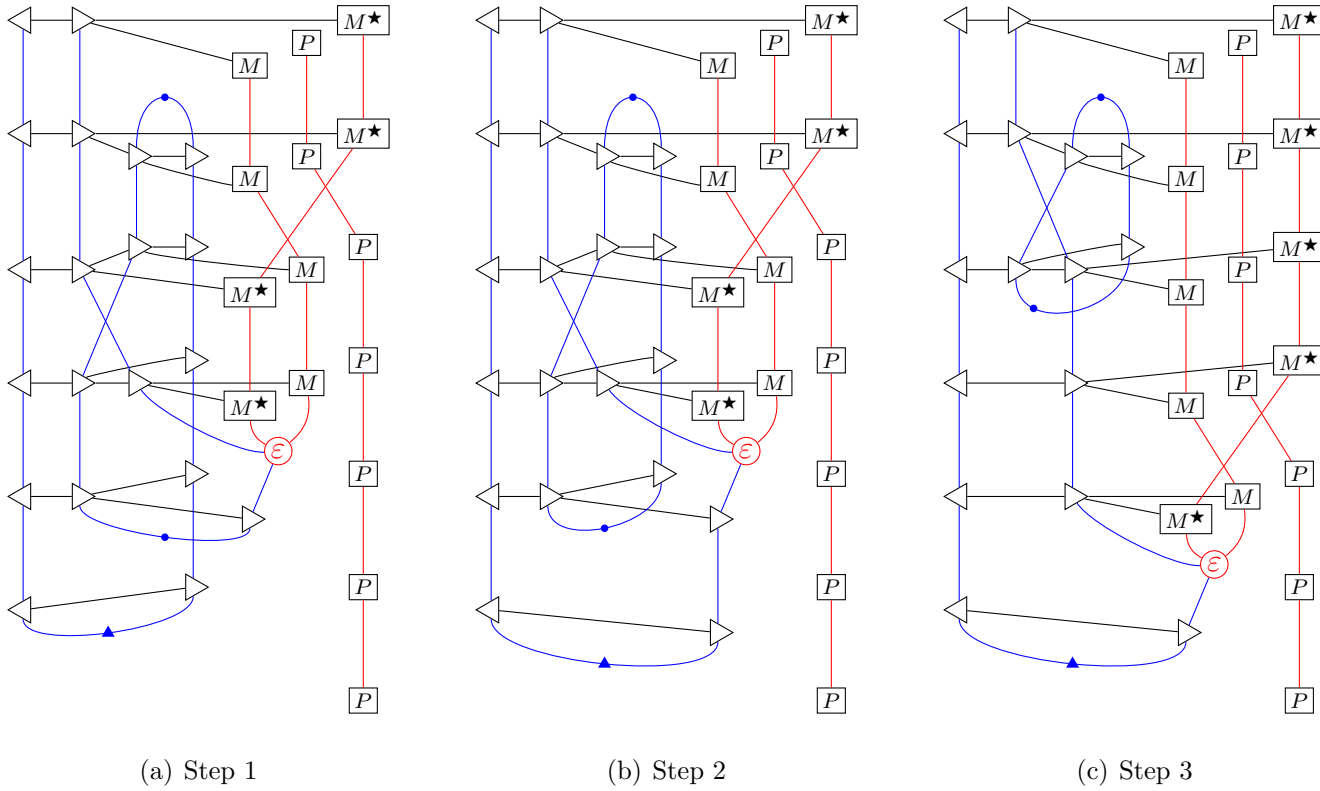

Figure 24: Lower part, from the proof of Theorem 6.9(i)

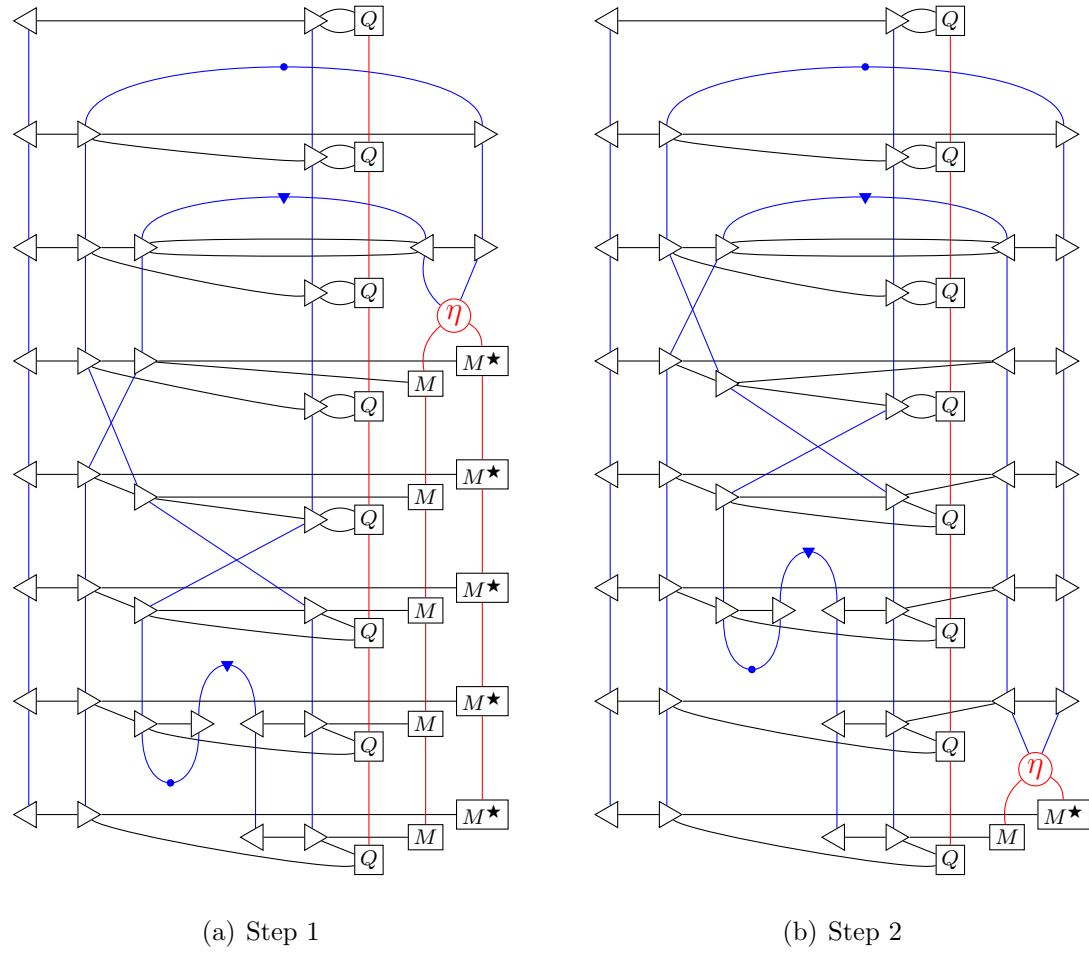
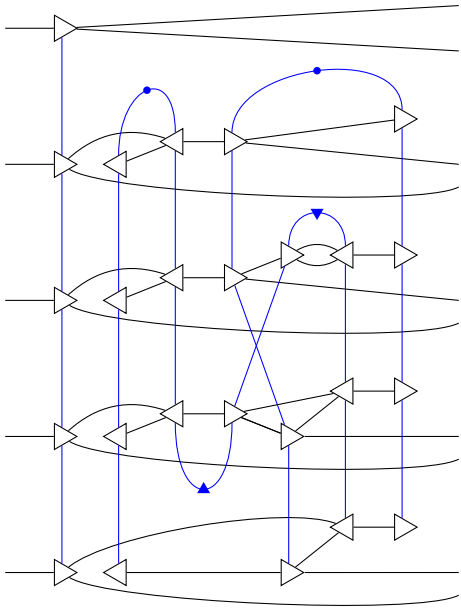
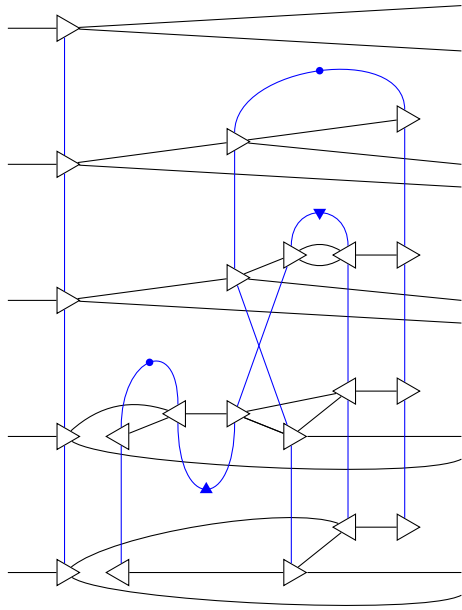

Figure 25: Upper part I, from the proof of Theorem 6.9(i)



(a) Step 1



(b) Step 2

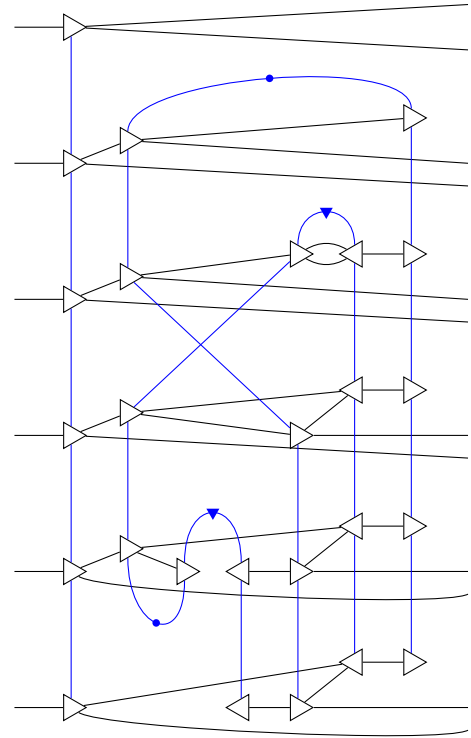

(c) Step 3

Figure 26: Upper part II, from the proof of Theorem 6.9(i)

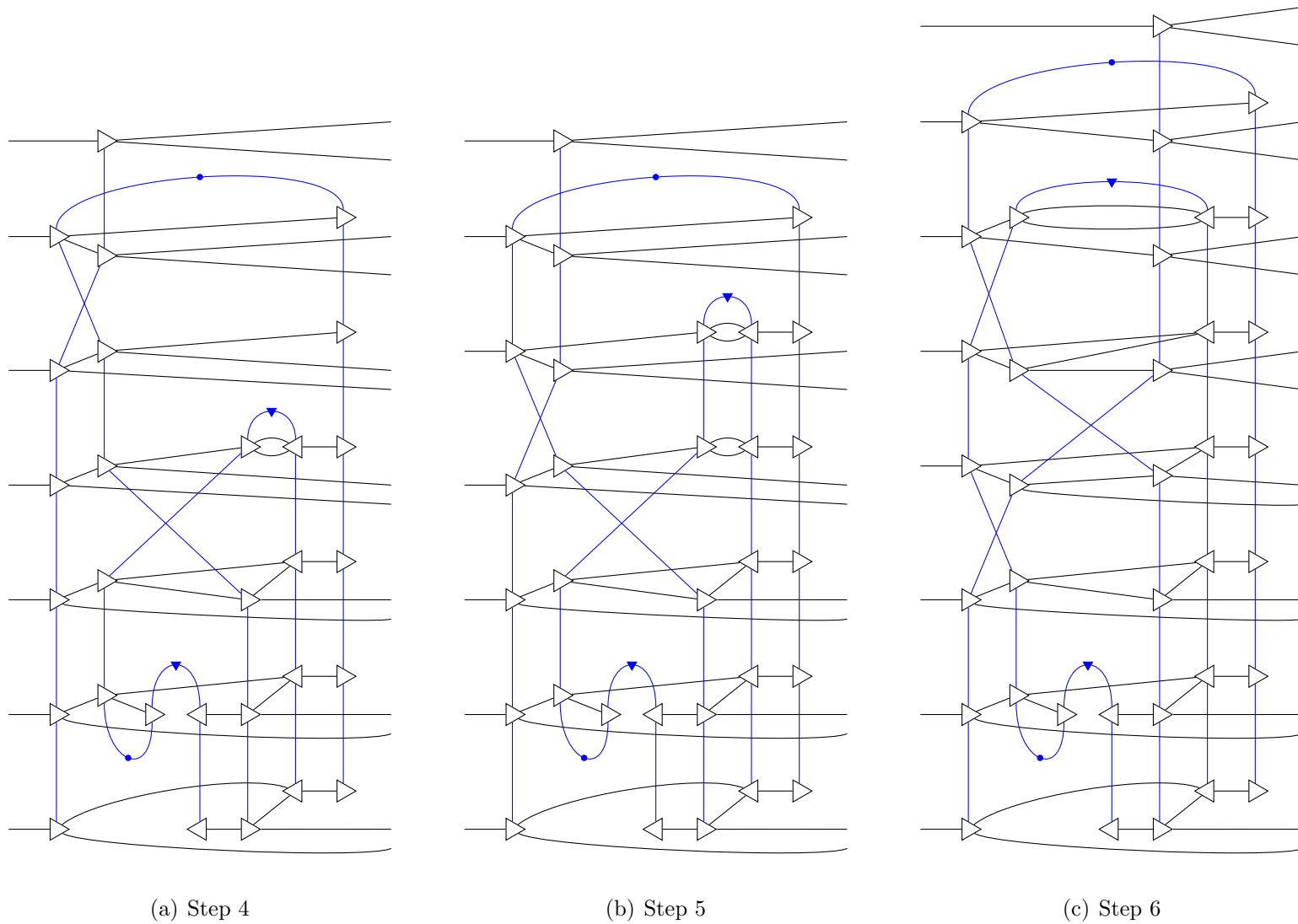
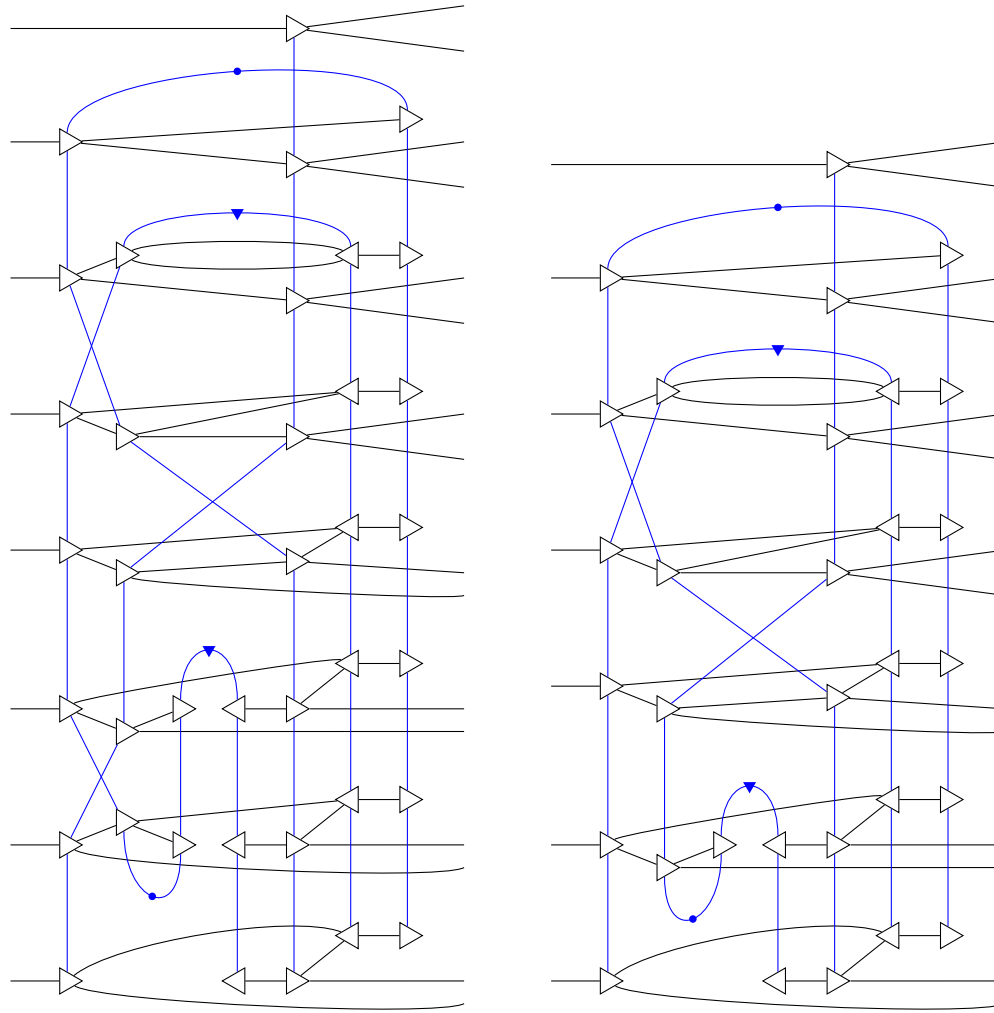

Figure 27: Upper part III, from the proof of Theorem 6.9(i)



(a) Step 7

(b) Step 8

Figure 28: Upper part IV, from the proof of Theorem 6.9(i)

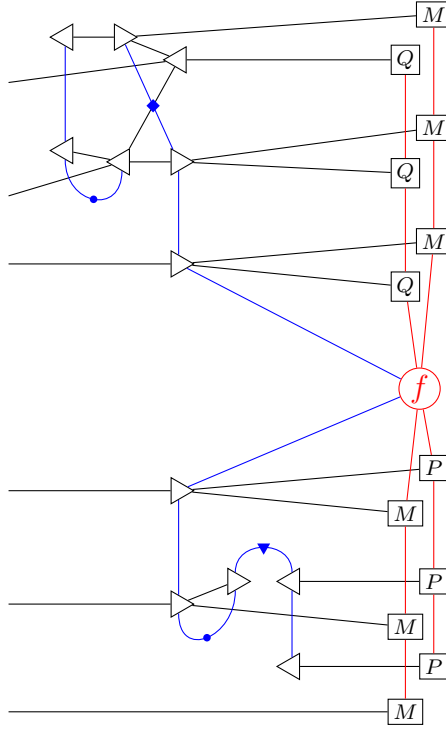

Figure 29: The map \tilde{f} in Theorem 6.9(ii)

This is pictured in Figure 29. We now claim that the following square commutes.

$$\begin{array}{ccc}
 Q \otimes M & \longrightarrow & (\Delta_A)^*(\Delta_A)!Q \otimes M \\
 f \downarrow & & \downarrow \tilde{f} \\
 M \otimes P & \longrightarrow & M \otimes (\pi_A)^*(\pi_A)!P
 \end{array} \tag{11.2}$$

To show this, we substitute \tilde{f} from Figure 29 as g in Figure 22(a) (replacing Q by $\Delta!Q$ and P by $\pi!P$). Canceling the isomorphism $\Delta^*(\text{id} \times \pi)^* \cong \text{Id}$ with its inverse, we see that what is left at the bottom of the resulting diagram is exactly the left-bottom composite of (11.2). Therefore, it suffices to show that what remains above this becomes the identity when composed with the top arrow in (11.2). By inverting the first two transitions in Figure 29, this is equivalent to the equality shown in Figure 30. However, this follows by a simple sliding and the broken zigzag identity from Figure 18(d).

Now, from the conclusion of (i) and the naturality of symmetric monoidal traces, we can conclude that the following diagram commutes.

$$\begin{array}{ccccc}
 (\pi_A)!Q & \longrightarrow & (\pi_A)!(\Delta_A)^*(\Delta_A)!Q & & \\
 (\pi_A)! \text{tr}(f) \downarrow & & (\pi_A)! \text{tr}(\tilde{f}) \downarrow & \searrow \text{tr}(\tilde{f}) & \\
 (\pi_A)!P & \longrightarrow & (\pi_A)!(\pi_A)^*(\pi_A)!P & \longrightarrow & (\pi_A)!P
 \end{array}$$

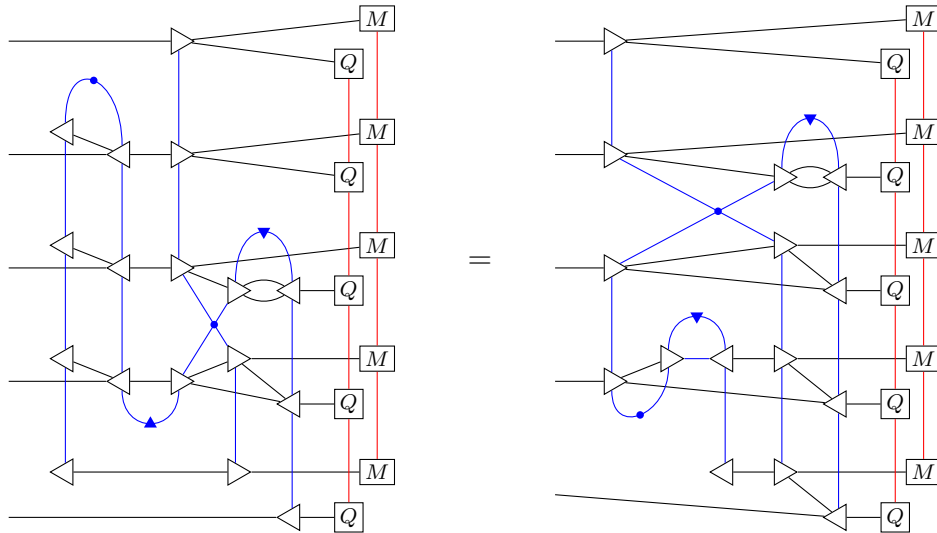

Figure 30: The sufficient condition for Theorem 6.9(ii)

But the composite along the bottom of this diagram is the identity, by a triangle law for the adjunction $(\pi_A)_! \dashv (\pi_A)^*$. This yields the desired result. ■

PROOF OF Theorem 6.9(iii) The bijection between the two types of morphism is immediate, since the respective domains and codomains are isomorphic. For a morphism $f: Q \otimes M \rightarrow M \otimes (\pi_A)^*P$, the corresponding $\tilde{f}: (\Delta_A)_!Q \odot \widehat{M} \rightarrow \widehat{M} \odot P$ is shown on the left side of Figure 31. Moreover, given $f: Q \otimes M \rightarrow M \otimes (\pi_A)^*P$, we can also construct \tilde{f} as in part (ii) (replacing P by $(\pi_A)^*P$), and we claim that \tilde{f} is the composite

$$(\Delta_A)_!Q \odot \widehat{M} \xrightarrow{\tilde{f}} \widehat{M} \odot (\pi_A)_!(\pi_A)^*P \xrightarrow{\text{id} \odot \epsilon} \widehat{M} \odot P. \tag{11.3}$$

This composite is shown on the right side of Figure 31; a slide and a triangle identity suffice to prove the equality. Now the desired result follows from the conclusion of part (ii) together with the naturality of bicategorical traces [29, Prop. 7.1]. ■

12. Proofs for total duality and trace

In contrast to the fiberwise case, our general comparison theorems for total duality traces were completely formal, not requiring any string diagram calculations. However, the two most interesting applications, namely Corollaries 8.13 and 8.17, required identifying the composites $\xi \circ f$ and $\zeta \circ f$ as $\Sigma(f)$ and $\Sigma(\Delta_A \circ f)$, respectively, and for this we do need some calculation.

Recall that we have an endomorphism $\phi: A \rightarrow A$ of $A \in \mathbf{S}$ and that we defined f to be the isomorphism

$$I_A \cong \phi^* I_A \tag{12.1}$$

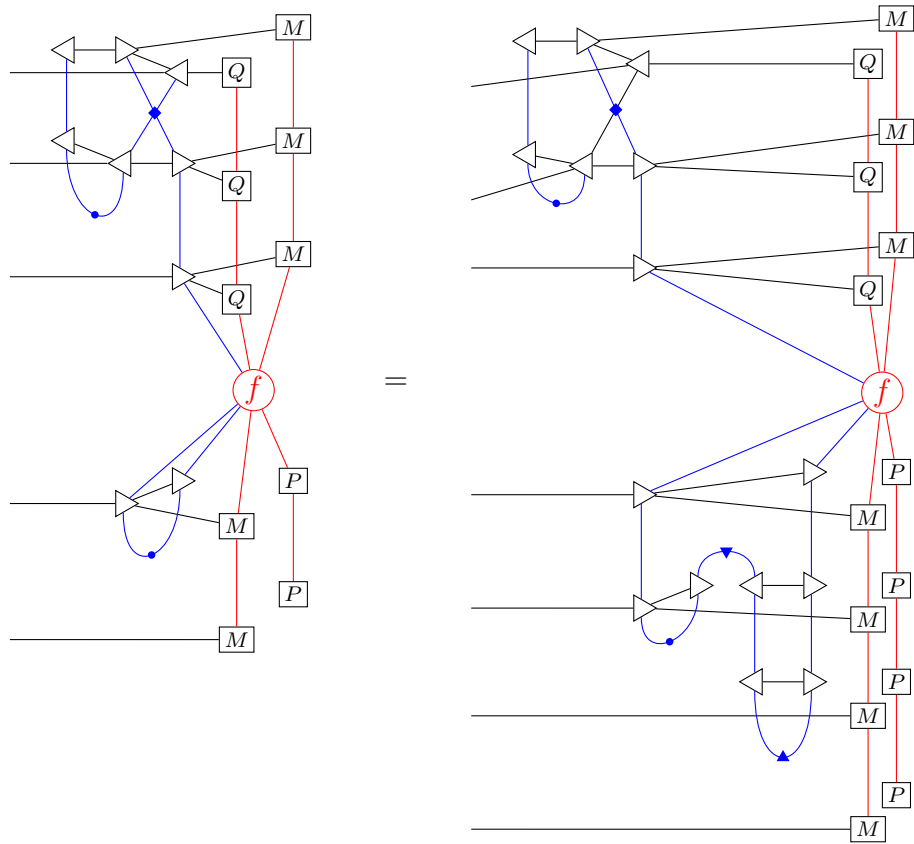

Figure 31: The map \hat{f} in Theorem 6.9(iii)

regarded as a morphism $\widetilde{I}_A \rightarrow \widetilde{I}_A \odot A_\phi$. We defined ξ be the morphism

$$A_\phi \odot \widehat{I}_A \xrightarrow{\cong} \widehat{\phi_! I_A} \xrightarrow{\cong} \widehat{\phi_! \phi^* I_A} \longrightarrow \widehat{I}_A.$$

By definition, then, the composite $\xi \circ f$ becomes

$$\begin{aligned} (\pi_A)_! I_A &\xrightarrow{\cong} \widetilde{I}_A \odot \widehat{I}_A \xrightarrow{\cong} \widetilde{\phi^* I_A} \odot \widehat{I}_A \xrightarrow{\cong} \widetilde{I}_A \odot A_\phi \odot \widehat{I}_A \xrightarrow{\cong} \widetilde{I}_A \odot \widehat{\phi_! I_A} \\ &\xrightarrow{\cong} \widetilde{I}_A \odot \widehat{\phi_! \phi^* I_A} \longrightarrow \widetilde{I}_A \odot \widehat{I}_A \xrightarrow{\cong} (\pi_A)_! I_A. \end{aligned} \tag{12.2}$$

To give a simpler description of this composite we start by considering the composite of only the third and fourth morphisms (the two on the second line of (12.2)). These are instances of Lemma 7.4. Tracing through their definitions yields a fairly long composite of isomorphisms, but fortunately it is equal to something simpler, as an instance of the following lemma.

12.3. LEMMA. *Let $M \in \mathcal{C}^B$, $N \in \mathcal{C}^A$, and let $\phi: A \rightarrow B$ be a morphism in \mathbf{S} . Then the composite*

$$\widetilde{\phi^* M} \odot \widehat{N} \xrightarrow{\cong} \widetilde{M} \odot B_\phi \odot \widehat{N} \xrightarrow{\cong} \widetilde{M} \odot \widehat{\phi_! N}. \tag{12.4}$$

is equal to

$$\begin{aligned} \widetilde{\phi^* M} \odot \widehat{N} &= (\pi_A)_!(\Delta_A)^*(\phi^* M \boxtimes N) \\ &\cong (\pi_B)_! \phi_!(\Delta_A)^*(\phi^* M \boxtimes N) \\ &\cong (\pi_B)_!(\Delta_B)^*(M \boxtimes \phi_! N) \\ &= \widetilde{M} \odot \widehat{\phi_! N}. \end{aligned}$$

PROOF. A straightforward, though tedious, verification, using the coherence of Beck-Chevalley morphisms (the techniques for computation with mates described in [19] are useful). ■

The composite displayed in Lemma 12.3 is shown graphically in Figure 32. Note the occurrence of the “sliding and splitting” Beck-Chevalley isomorphism (recall Figure 1(c)).

12.5. PROPOSITION. *The composite $\xi \circ f$ is $\Sigma(\phi)$.*

PROOF. Using Lemma 12.3, and unfolding the definition of the “sliding and splitting” Beck-Chevalley morphism, (12.2) becomes the morphism shown in Figure 34(a). In Figure 34(b) we simply rearrange the order of all the morphisms, sliding the counit $\phi_! \phi^* \rightarrow \text{Id}$ on the far left down to the bottom, the isomorphism $\phi^* \pi^* \cong \pi^*$ on the far right up to the top, and rearranging things in the middle so that the other unit and counit meet.

In Figure 35(a) we cancel the internal unit and counit using a triangle identity. Now we have the isomorphisms $\phi^* \pi^* \cong \pi^*$ and $\pi_! \phi_! \cong \pi_!$ at the top, a counit $\phi_! \phi^* \rightarrow \text{Id}$ at the bottom, and in the middle a composite of pseudofunctoriality isomorphisms for

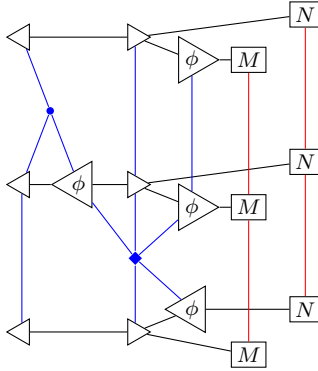

Figure 32: The simplified version of (12.4)

reindexing functors, which starts and ends at $\pi_! \phi_! \phi^* \pi^*$. This middle composite is extracted in Figure 35(b), after peeling off the $\pi_! \phi_!$ and π^* (which are unchanged throughout). By coherence for pseudofunctors, this composite is equal to the identity, so that Figure 35(a) is equal to Figure 35(c). But this is exactly $\Sigma(\phi)$ (see (4.3)). ■

This completes the proof of Corollary 8.13; we now move on to Corollary 8.17. In this case, we defined ζ to be the composite

$$A_\phi \odot \widehat{I}_A \xrightarrow{\xi} I_A \longrightarrow (\pi_A)^*(\pi_A)_! I_A \xrightarrow{\cong} \widehat{I}_A \odot \Sigma(A)$$

where ξ is as above.

12.6. PROPOSITION. *The composite $\xi \circ f$ is $\Sigma(\Delta_A \circ \phi)$.*

PROOF. Since ζ factors through ξ , $\zeta \circ f$ factors through $\xi \circ f$. Applying Proposition 12.5, we see that $\zeta \circ f$ is equal to the composite

$$\Sigma(A) \xrightarrow{\Sigma(\phi)} \Sigma(A) = (\pi_A)_! I_A \longrightarrow (\pi_A)_! (\pi_A)^*(\pi_A)_! I_A \xrightarrow{\cong} \Sigma(A) \otimes \Sigma(A).$$

Thus, it will suffice to show that the composite

$$(\pi_A)_! I_A \longrightarrow (\pi_A)_! (\pi_A)^*(\pi_A)_! I_A \xrightarrow{\cong} \Sigma(A) \otimes \Sigma(A). \tag{12.7}$$

is equal to $\Sigma(\Delta_A)$. Now, by definition, $\Sigma(\Delta_A)$ is equal to the composite in Figure 33(a). We can rewrite the initial pseudofunctoriality isomorphisms to obtain Figure 33(b), and then apply the broken zigzag identity (Figure 18(d)) to obtain Figure 33(c). In Figure 33(d) we isotope sideways, and then in Figure 33(e) we slide the adjunction unit to the top. Finally, we can cancel the isomorphisms in the middle by pseudofunctor coherence, obtaining Figure 33(f), which is exactly (12.7). ■

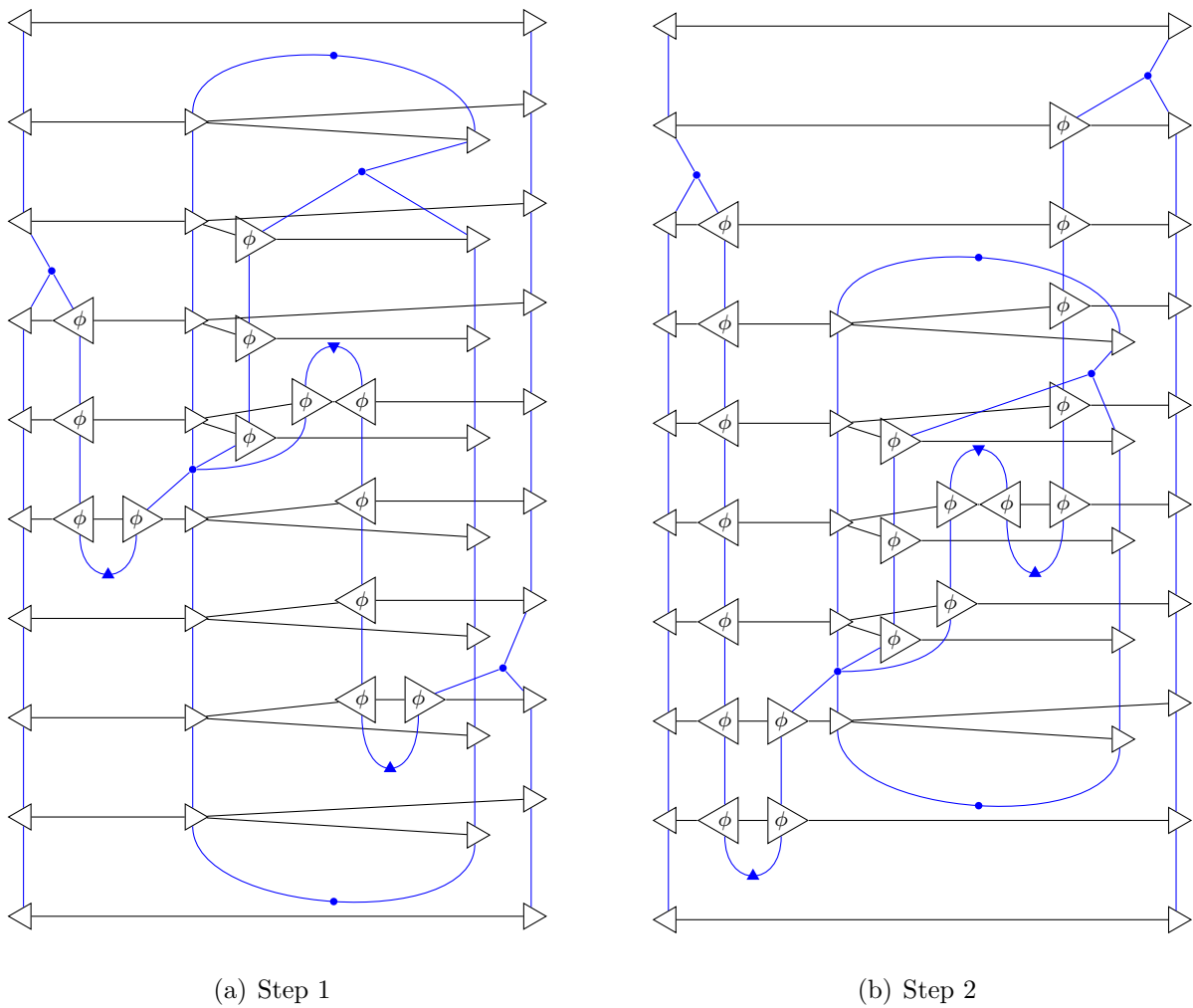

Figure 34: The composite $\xi \circ f$, steps 1–2

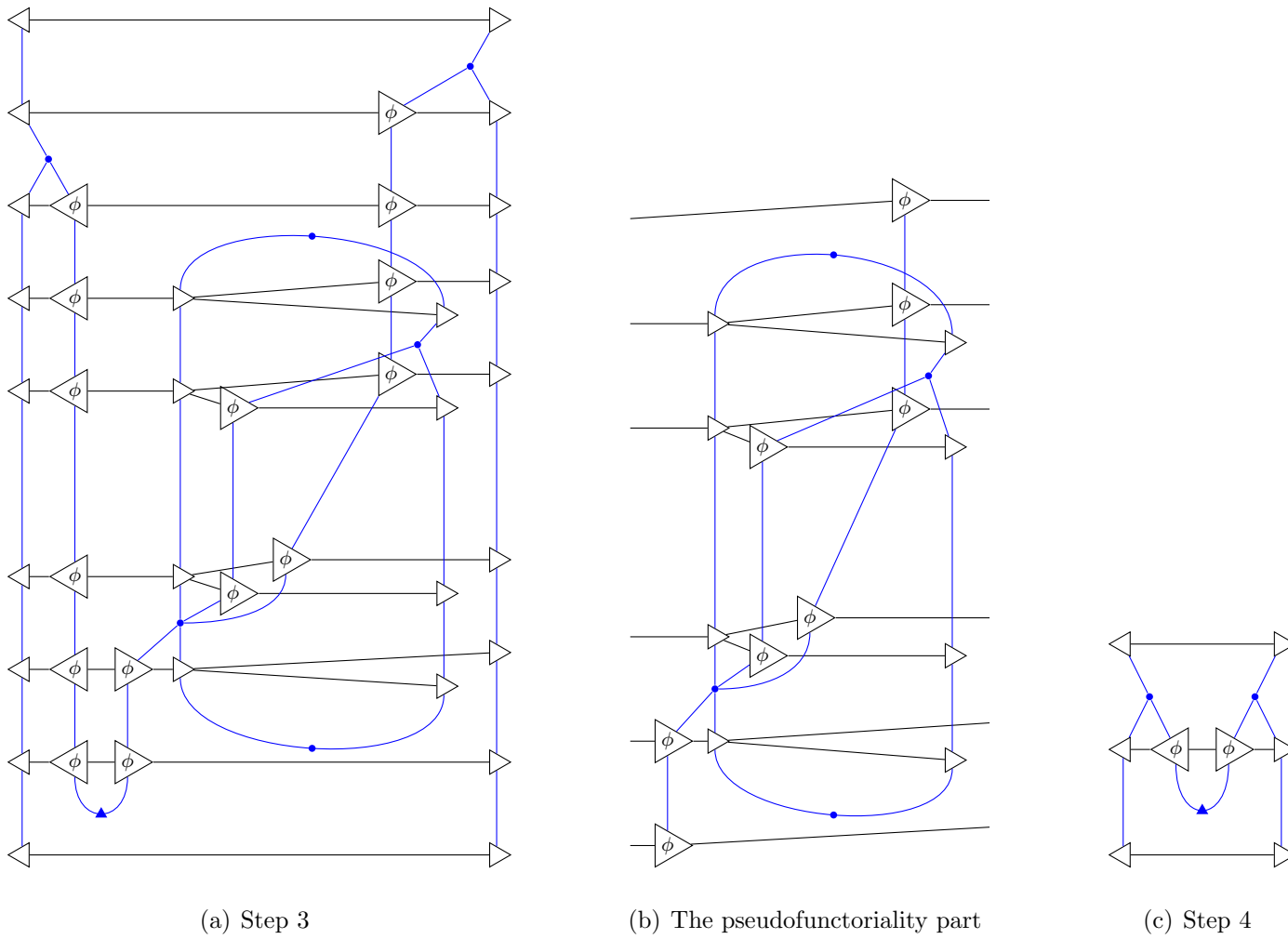

Figure 35: The composite $\xi \circ f$, steps 3–4

References

- [1] Geraldine Brady and Todd Trimble. A string diagram calculus for predicate logic. Preprint available at <http://people.cs.uchicago.edu/~brady/beta98.ps>, 1998. 626, 631
- [2] Paul Bressler. Cyclic stuff. Unpublished manuscript. 605
- [3] Kenneth S. Brown. *Cohomology of groups*, volume 87 of *Graduate Texts in Mathematics*. Springer-Verlag, New York, 1982. 617
- [4] Robert F. Brown. *The Lefschetz fixed point theorem*. Scott, Foresman and Co., Glenview, Ill.-London, 1971. 583, 624
- [5] Steven R. Costenoble and Stefan Waner. Equivariant ordinary homology and cohomology. arXiv:math.AT/0310237. 584
- [6] Brian Day and Ross Street. Monoidal bicategories and Hopf algebroids. *Adv. Math.*, 129(1):99–157, 1997. 613
- [7] Albrecht Dold. The fixed point index of fibre-preserving maps. *Invent. Math.*, 25:281–297, 1974. 608
- [8] Albrecht Dold and Dieter Puppe. Duality, trace, and transfer. In *Proceedings of the International Conference on Geometric Topology (Warsaw, 1978)*, pages 81–102, Warsaw, 1980. PWN. 583, 594, 595
- [9] Ignacio López Franco. *Autonomous pseudomonoids*. PhD thesis, Trinity College, 2008. 613
- [10] Peter J. Freyd and Andre Scedrov. *Categories, allegories*, volume 39 of *North-Holland Mathematical Library*. North-Holland Publishing Co., Amsterdam, 1990. 602
- [11] Akira Hattori. Rank element of a projective module. *Nagoya Math. J.*, 25:113–120, 1965. 599
- [12] Bo Ju Jiang. *Lectures on Nielsen fixed point theory*, volume 14 of *Contemporary Mathematics*. American Mathematical Society, Providence, R.I., 1983. 583, 624
- [13] Peter T. Johnstone. *Sketches of an Elephant: A Topos Theory Compendium: Volume 1*. Number 43 in Oxford Logic Guides. Oxford Science Publications, 2002. 586
- [14] André Joyal and Ross Street. The geometry of tensor calculus. II. Draft available at <http://www.math.mq.edu.au/~street/GTCII.pdf>. 585
- [15] André Joyal and Ross Street. Planar diagrams and tensor algebra. Draft available at <http://www.math.mq.edu.au/~street/PlanarDiags.pdf>. 585

- [16] André Joyal and Ross Street. The geometry of tensor calculus. I. *Adv. Math.*, 88(1):55–112, 1991. [585](#)
- [17] André Joyal, Ross Street, and Dominic Verity. Traced monoidal categories. *Math. Proc. Cambridge Philos. Soc.*, 119(3):447–468, 1996. [583](#), [585](#), [594](#)
- [18] G. M. Kelly and M. L. Laplaza. Coherence for compact closed categories. *J. Pure Appl. Algebra*, 19:193–213, 1980. [583](#), [594](#)
- [19] G. M. Kelly and Ross Street. Review of the elements of 2-categories. In *Category Seminar (Proc. Sem., Sydney, 1972/1973)*, volume 420 of *Lecture Notes in Mathematics*, pages 75–103. Springer, Berlin, 1974. [591](#), [652](#)
- [20] F. William Lawvere. Equality in hyperdoctrines and comprehension schema as an adjoint functor. In *Applications of Categorical Algebra (Proc. Sympos. Pure Math., Vol. XVII, New York, 1968)*, pages 1–14. Amer. Math. Soc., Providence, R.I., 1970. [590](#), [594](#)
- [21] F. William Lawvere. Adjointness in foundations. *Repr. Theory Appl. Categ.*, (16):1–16 (electronic), 2006. Reprinted from *Dialectica* **23** (1969). [594](#)
- [22] J. P. May and J. Sigurdsson. *Parametrized homotopy theory*, volume 132 of *Mathematical Surveys and Monographs*. American Mathematical Society, Providence, RI, 2006. [583](#), [584](#), [585](#), [587](#), [589](#), [593](#), [600](#), [603](#), [605](#), [606](#), [607](#), [614](#), [619](#)
- [23] Robert Paré and Dietmar Schumacher. Abstract families and the adjoint functor theorems. In *Indexed categories and their applications*, volume 661 of *Lecture Notes in Math.*, pages 1–125. Springer, Berlin, 1978. [586](#)
- [24] Roger Penrose. Applications of negative dimensional tensors. In *Combinatorial Mathematics and its Applications (Proc. Conf., Oxford, 1969)*, pages 221–244. Academic Press, London, 1971. [585](#)
- [25] Kate Ponto. Equivariant fixed point theory. arXiv:0910.1274. [583](#)
- [26] Kate Ponto. Coincidence invariants and higher Reidemeister traces. arXiv:1209.3710. [586](#)
- [27] Kate Ponto. Fixed point theory and trace for bicategories. *Astérisque*, (333):xii+102, 2010. arXiv:0807.1471. [583](#), [585](#), [598](#), [599](#)
- [28] Kate Ponto. Relative fixed point theory. *Algebr. Geom. Topol.*, 11(2):839–886, 2011. [583](#)
- [29] Kate Ponto and Michael Shulman. Shadows and traces for bicategories. *Journal of homotopy and related structures*. To appear. arXiv:0910.1306. [585](#), [598](#), [599](#), [602](#), [603](#), [616](#), [619](#), [620](#), [650](#)

- [30] Robert A. G. Seely. Hyperdoctrines, natural deduction and the Beck condition. *Z. Math. Logik Grundlag. Math.*, 29(6):505–542, 1983. 590
- [31] Peter Selinger. A survey of graphical languages for monoidal categories. In Bob Coecke, editor, *New Structures for Physics*, chapter 4. Springer, 2011. Available at <http://www.mscs.dal.ca/~selinger/papers.html#graphical> and arXiv:0908.3347. 585
- [32] Michael Shulman. Constructing symmetric monoidal bicategories. arXiv:1004.0993. 602
- [33] Michael Shulman. Framed bicategories and monoidal fibrations. *Theory and Applications of Categories*, 20(18):650–738 (electronic), 2008. Also available as arXiv:0706.1286. 585, 588, 593, 600, 601, 602, 614
- [34] Michael A. Shulman. Comparing composites of left and right derived functors. *New York Journal of Mathematics*, 17:75–125, 2011. 593
- [35] John Stallings. Centerless groups—an algebraic formulation of Gottlieb’s theorem. *Topology*, 4:129–134, 1965. 599
- [36] Ross Street. Low-dimensional topology and higher-order categories I. Proceedings of CT95, Halifax, July 1995. Available at <http://www.mta.ca/~cat-dist/CT95Docs/LowDim.ps>. 585
- [37] Todd Trimble. Notes on predicate logic. <http://ncatlab.org/toddtrimble/published/Notes+on+predicate+logic>. 590, 592
- [38] Todd Trimble et al. Frobenius reciprocity. <http://ncatlab.org/nlab/show/Frobenius+reciprocity>, August 2011. 592
- [39] R.F.C. Walters. Categorical algebras of relations. <http://rfcwalters.blogspot.com/2009/10/categorical-algebras-of-relations.html>, October 2009. 592
- [40] Charles A. Weibel. *An introduction to homological algebra*, volume 38 of *Cambridge Studies in Advanced Mathematics*. Cambridge University Press, Cambridge, 1994. 616, 618
- [41] R. J. Wood. Abstract proarrows. I. *Cahiers Topologie Géom. Différentielle*, 23(3):279–290, 1982. 614

This article may be accessed at <http://www.tac.mta.ca/tac/> or by anonymous ftp at [{dvi,ps,pdf}](ftp://ftp.tac.mta.ca/pub/tac/html/volumes/26/23/26-23)

THEORY AND APPLICATIONS OF CATEGORIES (ISSN 1201-561X) will disseminate articles that significantly advance the study of categorical algebra or methods, or that make significant new contributions to mathematical science using categorical methods. The scope of the journal includes: all areas of pure category theory, including higher dimensional categories; applications of category theory to algebra, geometry and topology and other areas of mathematics; applications of category theory to computer science, physics and other mathematical sciences; contributions to scientific knowledge that make use of categorical methods.

Articles appearing in the journal have been carefully and critically refereed under the responsibility of members of the Editorial Board. Only papers judged to be both significant and excellent are accepted for publication.

Full text of the journal is freely available in .dvi, Postscript and PDF from the journal's server at <http://www.tac.mta.ca/tac/> and by ftp. It is archived electronically and in printed paper format.

SUBSCRIPTION INFORMATION Individual subscribers receive abstracts of articles by e-mail as they are published. To subscribe, send e-mail to tac@mta.ca including a full name and postal address. For institutional subscription, send enquiries to the Managing Editor, Robert Rosebrugh, rrosebrugh@mta.ca.

INFORMATION FOR AUTHORS The typesetting language of the journal is \TeX , and $\text{\LaTeX}2\epsilon$ strongly encouraged. Articles should be submitted by e-mail directly to a Transmitting Editor. Please obtain detailed information on submission format and style files at <http://www.tac.mta.ca/tac/>.

MANAGING EDITOR Robert Rosebrugh, Mount Allison University: rrosebrugh@mta.ca

\TeX EDITOR Michael Barr, McGill University: barr@math.mcgill.ca

ASSISTANT \TeX EDITOR Gavin Seal, Ecole Polytechnique Fédérale de Lausanne: gavin_seal@fastmail.fm

TRANSMITTING EDITORS

Clemens Berger, Université de Nice-Sophia Antipolis, cberger@math.unice.fr

Richard Blute, Université d' Ottawa: rblute@uottawa.ca

Lawrence Breen, Université de Paris 13: breen@math.univ-paris13.fr

Ronald Brown, University of North Wales: [ronnie.profbrown\(at\)btinternet.com](mailto:ronnie.profbrown(at)btinternet.com)

Valeria de Paiva: valeria.depaiva@gmail.com

Ezra Getzler, Northwestern University: [getzler\(at\)northwestern\(dot\)edu](mailto:getzler(at)northwestern(dot)edu)

Kathryn Hess, Ecole Polytechnique Fédérale de Lausanne : kathryn.hess@epfl.ch

Martin Hyland, University of Cambridge: M.Hyland@dpmms.cam.ac.uk

Anders Kock, University of Aarhus: kock@imf.au.dk

Stephen Lack, Macquarie University: steve.lack@mq.edu.au

F. William Lawvere, State University of New York at Buffalo: wlawvere@buffalo.edu

Tom Leinster, University of Edinburgh, Tom.Leinster@ed.ac.uk

Ieke Moerdijk, University of Utrecht: moerdijk@math.uu.nl

Susan Niefield, Union College: niefiels@union.edu

Robert Paré, Dalhousie University: pare@mathstat.dal.ca

Jiri Rosicky, Masaryk University: rosicky@math.muni.cz

Giuseppe Rosolini, Università di Genova: rosolini@disi.unige.it

Alex Simpson, University of Edinburgh: Alex.Simpson@ed.ac.uk

James Stasheff, University of North Carolina: jds@math.upenn.edu

Ross Street, Macquarie University: street@math.mq.edu.au

Walter Tholen, York University: tholen@mathstat.yorku.ca

Myles Tierney, Rutgers University: tierney@math.rutgers.edu

Robert F. C. Walters, University of Insubria: robert.walters@uninsubria.it

R. J. Wood, Dalhousie University: rjwood@mathstat.dal.ca