

**Documents in support of Mr. Karlheinz Schreiber's testimony**

**KARLHEINZ SCHREIBER**

**INDEX**

**Binder #4: Correspondence between Brian Mulroney and Karlheinz Schreiber**

<b>TAB</b>	<b>Document</b>
1.	Telegram from Mr. Mulroney to Mr. Schreiber, dated February 28, 1982 <u>3<sup>rd</sup> party document</u>
2.	Letter from Mr. Schreiber to Mr. Mulroney, dated August 28, 1989 <u>3<sup>rd</sup> party document</u>
3.	Letter from Mr. Mulroney to Mr. Schreiber, dated September 18, 1989 <u>3<sup>rd</sup> party document</u>
4.	Letter from Mr. Schreiber to Mr. Mulroney, dated July 6, 1990 <u>3<sup>rd</sup> party document</u>
5.	Letter to Mr. Mulroney from Mr. Schreiber, dated August 27, 1990 <u>3<sup>rd</sup> party document</u>
6.	Letter to Mr. Mulroney from Mr. Schreiber, dated October 10, 1990 <u>3<sup>rd</sup> party document</u>
7.	Letter from Mr. Mulroney to Mr. Schreiber, dated April 19, 1991 <u>3<sup>rd</sup> party document</u>
8.	Letter from Mr. Schreiber to Mr. Mulroney, dated May 9, 1991 <u>3<sup>rd</sup> party document</u>
9.	Letter to Mr. Mulroney from Mr. Schreiber, dated May 6, 1992 <u>3<sup>rd</sup> party document</u>
10.	Letter to Mr. Mulroney from Mr. Schreiber, dated May 13, 1992 <u>3<sup>rd</sup> party document</u>
11.	Letter to Mr. Mulroney from Mr. Schreiber, dated May 22, 1992 <u>3<sup>rd</sup> party document</u>
12.	Letter from Mr. Schreiber to Mr. Mulroney, dated December 3, 1992 <u>3<sup>rd</sup> party document</u>
13.	Letter from Mr. Schreiber to Mr. Mulroney, dated March 15, 1993 <u>3<sup>rd</sup> party document</u>
14.	Letter from Mr. Schreiber to Mr. Mulroney, dated March 16, 1993 <u>3<sup>rd</sup> party document</u>
15.	Letter from Mr. Schreiber to Mr. Mulroney, dated March 23, 1993 <u>3<sup>rd</sup> party document</u>
16.	Letter to Mr. Mulroney from Mr. Schreiber, dated March 24, 1993 <u>3<sup>rd</sup> party document</u>

17.	Letter from Mr. Mulrone y to Mr. Schreiber, dated March 29, 1993 <u>3<sup>rd</sup> party document</u>
18.	Letter from Mr. Mulrone y to Mr. Schreiber, dated March 25, 1994 <u>3<sup>rd</sup> party document</u>
19.	Letter from Mila Mulrone y to Barbel, dated January 24, 2000 <u>3<sup>rd</sup> party document</u>
20.	Letter from Mr. Schreiber to Mr. Mulrone y, dated January 14, 2004 <u>3<sup>rd</sup> party document</u>
21.	Letter from Mr. Schreiber to Mr. Mulrone y, dated January 25, 2004 <u>3<sup>rd</sup> party document</u>
22.	Letter from Mr. Schreiber to Mr. Mulrone y, dated July 2004 <u>3<sup>rd</sup> party document</u>
23.	Letter from Mr. Schreiber to Mr. Mulrone y, dated July 22, 2004 <u>3<sup>rd</sup> party document</u>
24.	Email from Elmer MacKay to Mr. Schreiber, dated June 25, 2006 <u>3<sup>rd</sup> party document</u>
25.	Letter to Mr. Mulrone y from Mr. Schreiber, dated June 30, 2006 <u>3<sup>rd</sup> party document</u>
26.	Letter from Mr. Schreiber to Mr. Mulrone y, dated July 20, 2006 <u>3<sup>rd</sup> party document</u>
27.	Letter from Mr. Schreiber to Mr. Mulrone y, dated August 4, 2006 <u>3<sup>rd</sup> party document</u>
28.	Letter from Mr. Schreiber to Mr. Mulrone y, dated August 7, 2006 <u>3<sup>rd</sup> party document</u>
29.	Letter from Mr. Schreiber to Mr. Mulrone y, dated August 9, 2006 <u>3<sup>rd</sup> party document</u>
30.	Fax from Mr. Schreiber to Mr. Mulrone y, dated August 10, 2006 <u>3<sup>rd</sup> party document</u>
31.	Fax from Mr. Schreiber to Mr. Mulrone y, dated August 10, 2006 <u>3<sup>rd</sup> party document</u>
32.	Fax transmission to Mr. Mulrone y from Mr. Schreiber, dated August 18, 2006 <u>3<sup>rd</sup> party document</u>
33.	Letter to Mr. Mulrone y from Mr. Schreiber, dated August 23, 2006 <u>3<sup>rd</sup> party document</u>
34.	Letter to Mr. Mulrone y from Mr. Schreiber, dated October 25, 2006 <u>3<sup>rd</sup> party document</u>
35.	Letter to Mr. Mulrone y from Mr. Schreiber, dated November 30, 2006 <u>3<sup>rd</sup> party document</u>
36.	Letter to Mr. Mulrone y from Mr. Schreiber, dated January 19, 2007 <u>3<sup>rd</sup> party document</u>
37.	Letter to Mr. Mulrone y from Mr. Schreiber, dated January 29, 2007 <u>3<sup>rd</sup> party document</u>

<b>38.</b>	Letter to Mr. Mulronev from Mr. Schreiber, dated February 20, 2007 <u>3<sup>rd</sup> party document</u>
<b>39.</b>	Letter to Mr. Mulronev from Mr. Schreiber, dated March 29, 2007 <u>3<sup>rd</sup> party document</u>
<b>40.</b>	Letter to Mr. Mulronev from Mr. Schreiber, dated April 10, 2007 <u>3<sup>rd</sup> party document</u>
<b>41.</b>	Letter to Mr. Mulronev from Mr. Schreiber, dated April 14, 2007 <u>3<sup>rd</sup> party document</u>
<b>42.</b>	Letter to Mr. Mulronev from Mr. Schreiber, dated April 15, 2007 <u>3<sup>rd</sup> party document</u>
<b>43.</b>	Letter to Mr. Mulronev from Mr. Schreiber, dated May 8, 2007 <u>3<sup>rd</sup> party document</u>
<b>44.</b>	Letter to Mr. Mulronev from Mr. Schreiber, dated May 16, 2007 <u>3<sup>rd</sup> party document</u>

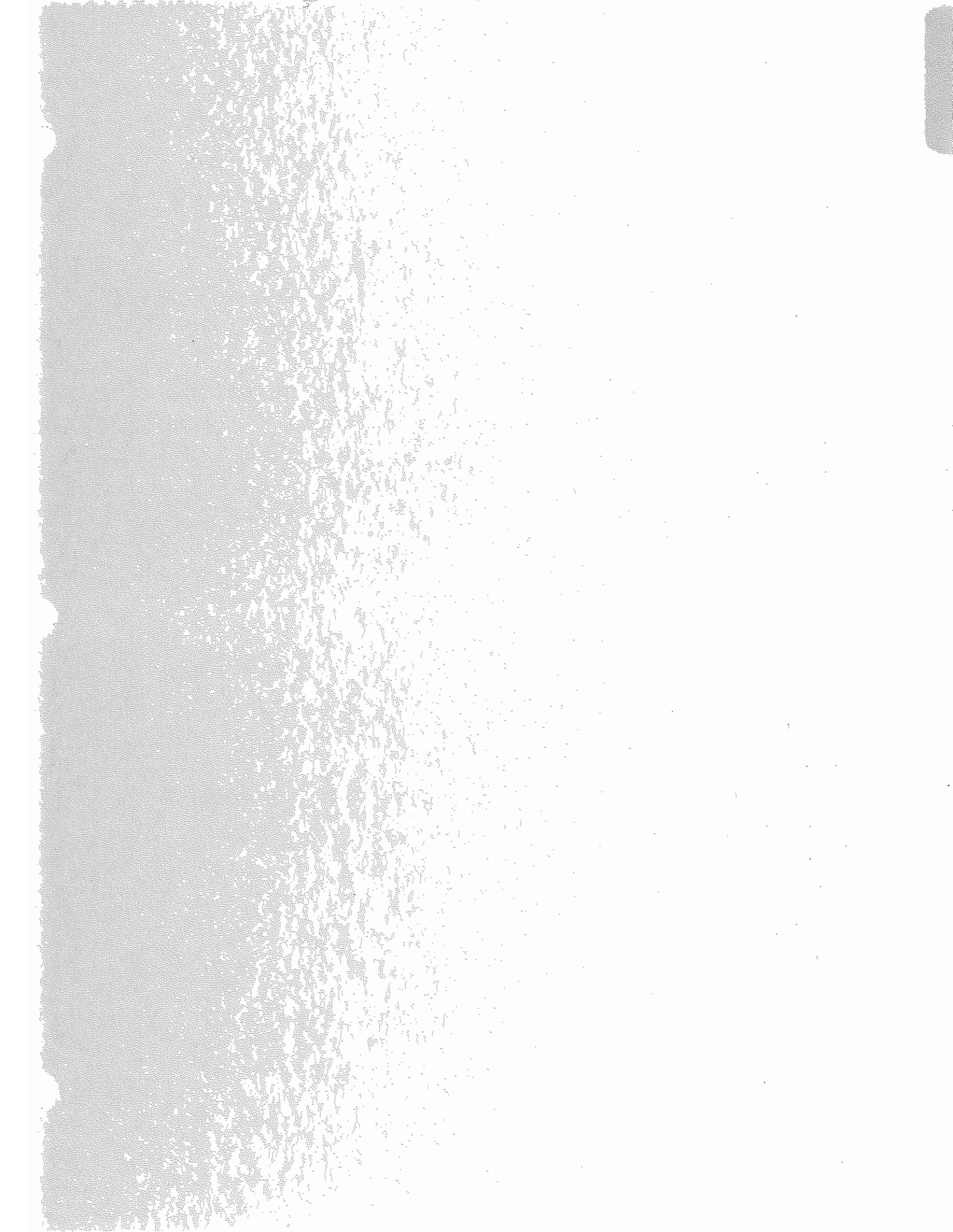

08/28/89 19:17 0613 748 9697

001

583472 1243 230282  
INTLX MTL CA \*  
RITZCARLTN MTL

PTS  
51 929830 +=  
MOM

OCC  
\*  
RITZCARLTN MTL

INCP MSG SVC  
00E835 FEE 23 1252 EST

HMB553 MMB846 MCCN537 28 FR  
CRT MONTREAL QUE 23 1242 (TEL ET LIVRAISON 842-1212

MR KARLHEINZE SCHREIFER C/O RITZ CARLTON HOTEL ROOM: 725  
1228 SHERBROOKE OUEST MONTREAL QUE (LIVRAISON PAYEE P.M.)

BT  
DEAR KARLHEINZE,  
CONGRATULATIONS AND BEST WISHES ON THIS IMPORTANT  
AND FIRST DAY OF YOUR NEW RELATIONSHIP WITH OUR COUNTRY.  
IT IS A PLEASURE TO WELCOME YOU TO CANADA.  
ERIAN MULRONEY

a4  
RITZCARLTN MTL

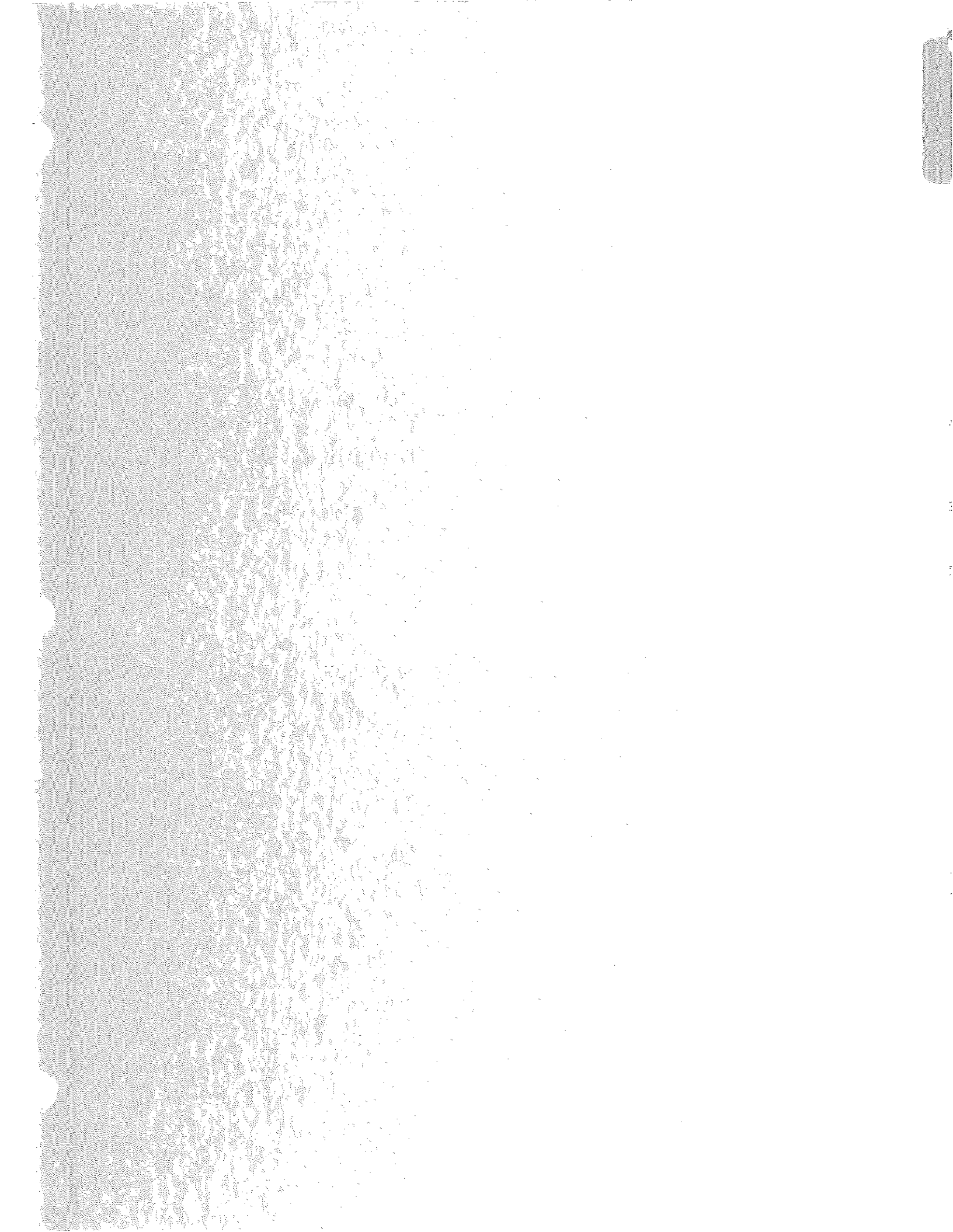

KARLHEINZ SCHREIBER  
MAGKAY LAKE ESTATES  
7 BITTERN COURT  
ROCKCLIFFE PARK  
OTTAWA, CANADA  
K1L 6K9

August 28, 1989

The Right Honourable Brian Mulroney,  
Prime Minister of Canada,  
House of Commons,  
Ottawa, Canada

Dear Brian,

I very much enjoyed meeting with you last week; it was an unexpected pleasure and especially because only a few days ago, I was cleaning out some old boxes and came upon my 1982 Canadian citizenship papers, and a kind telegram from a friend. I enclose copies.

When I was in Alberta, I was struck by the support you enjoyed (compared, say, to Premier Getty).

I listened with great interest to your address to the P.C. Annual Meeting and was especially moved by your remarks concerning education and the challenge to the young. I was reminded of the days in post-war Germany when we knew that we had better find ways of keeping our brightest in the country; if we lost our engineers, our children would become slaves of the high-tech countries. I too am working to create quality jobs for our children in this great country of mine that is Canada.

I salute you and your accomplishments. Please receive my kindest regards.

Sincerely,

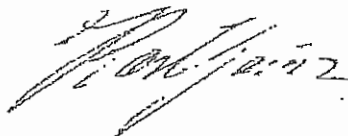

08/28/89 19:17 0613 748 9697

001

SB3472 1243 230282  
INTLX MTL CA \*  
RITZCARLTN MTL

PTS  
51 929830 +=  
MOM

OCC  
\*  
RITZCARLTN MTL

NCP MSG SVC  
006835 FEE 23 1252 EST

HMB553 MMCB45 MCCN537 28 FR  
CRT MONTREAL QUE 23 1242 (TEL ET LIVRAISON 642-1212

MR KARLHEINZE SCHREIPER C/O RITZ CARLTON HOTEL ROOM:725  
1228 SHERBROOKE OUEST MONTREAL QUE (LIVRAISON PAYEE P.M.)

BT  
DEAR KARLHEINZE,  
CONGRATULATIONS AND BEST WISHES ON THIS IMPORTANT  
AND FIRST DAY OF YOUR NEW RELATIONSHIP WITH OUR COUNTRY.  
IT IS A PLEASURE TO WELCOME YOU TO CANADA.  
BRIAN MULRONEY

2+  
RITZCARLTN MTL



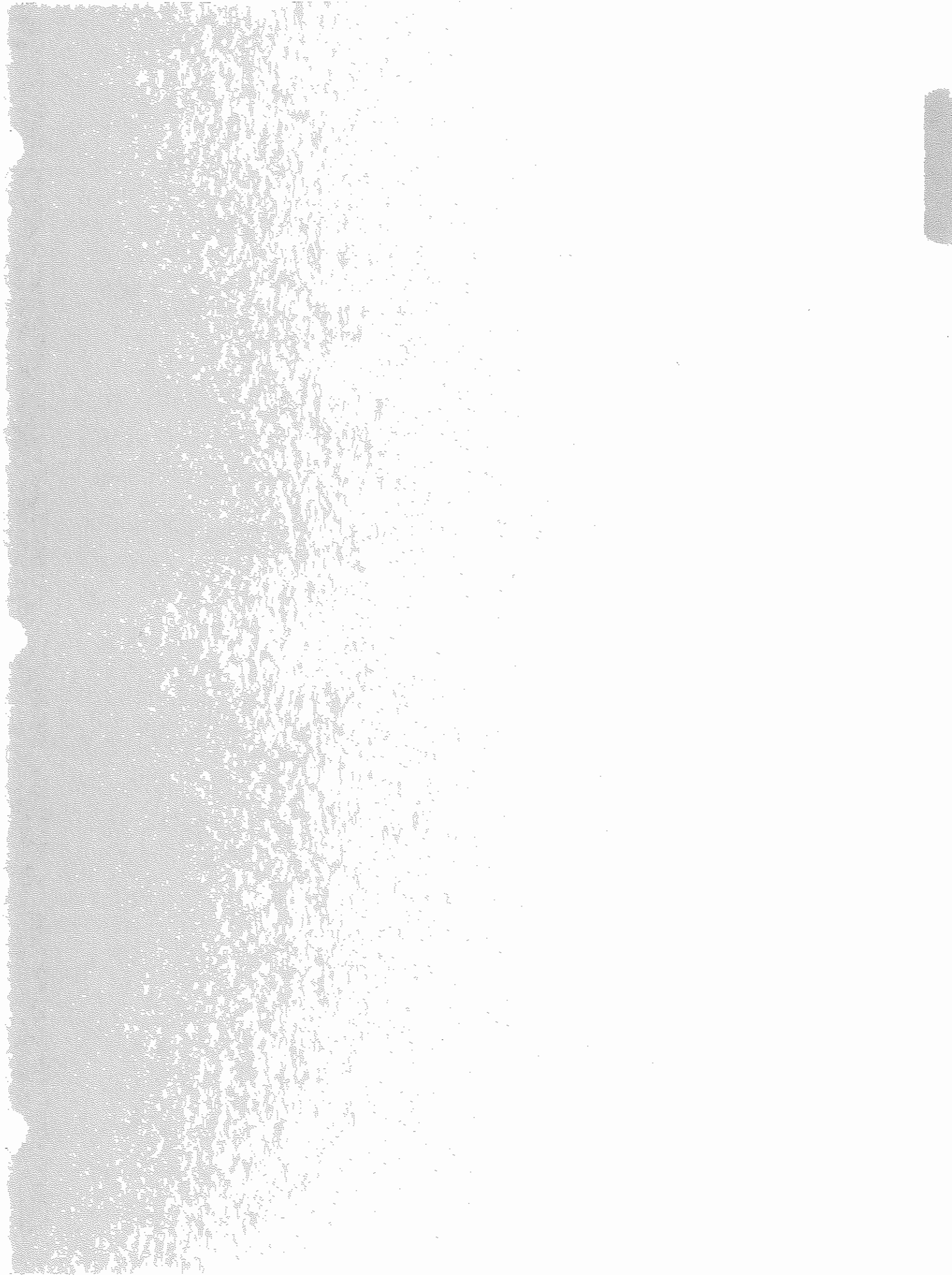



PRIME MINISTER · PREMIER MINISTRE

September 18, 1989

Dear Karlheinz,

Thank you for your letter of August 28.

I too was pleased to have the opportunity to meet with you. The recent General Meeting provided a tremendous opportunity for the PC Party to reflect on its past success and to look ahead to a future that promises to offer Canadians countless opportunities both at home and abroad.

It was with interest that I read the telegram I sent you back in 1982 when you received your Canadian citizenship. That date now seems so long ago; a lot has happened in the space of a few short years. You can be proud of your contribution to helping to ensure the continued growth and future prosperity of your new home, Canada.

Once again, thank you for writing. It was a pleasure to hear from you.

With kindest personal regards,

Yours sincerely,

Mr. Karlheinz Schreiber,  
MacKay Lake Estates,  
7 Bittern Court,  
Rockcliffe Park,  
Ottawa, Ontario.  
K1L 8K9

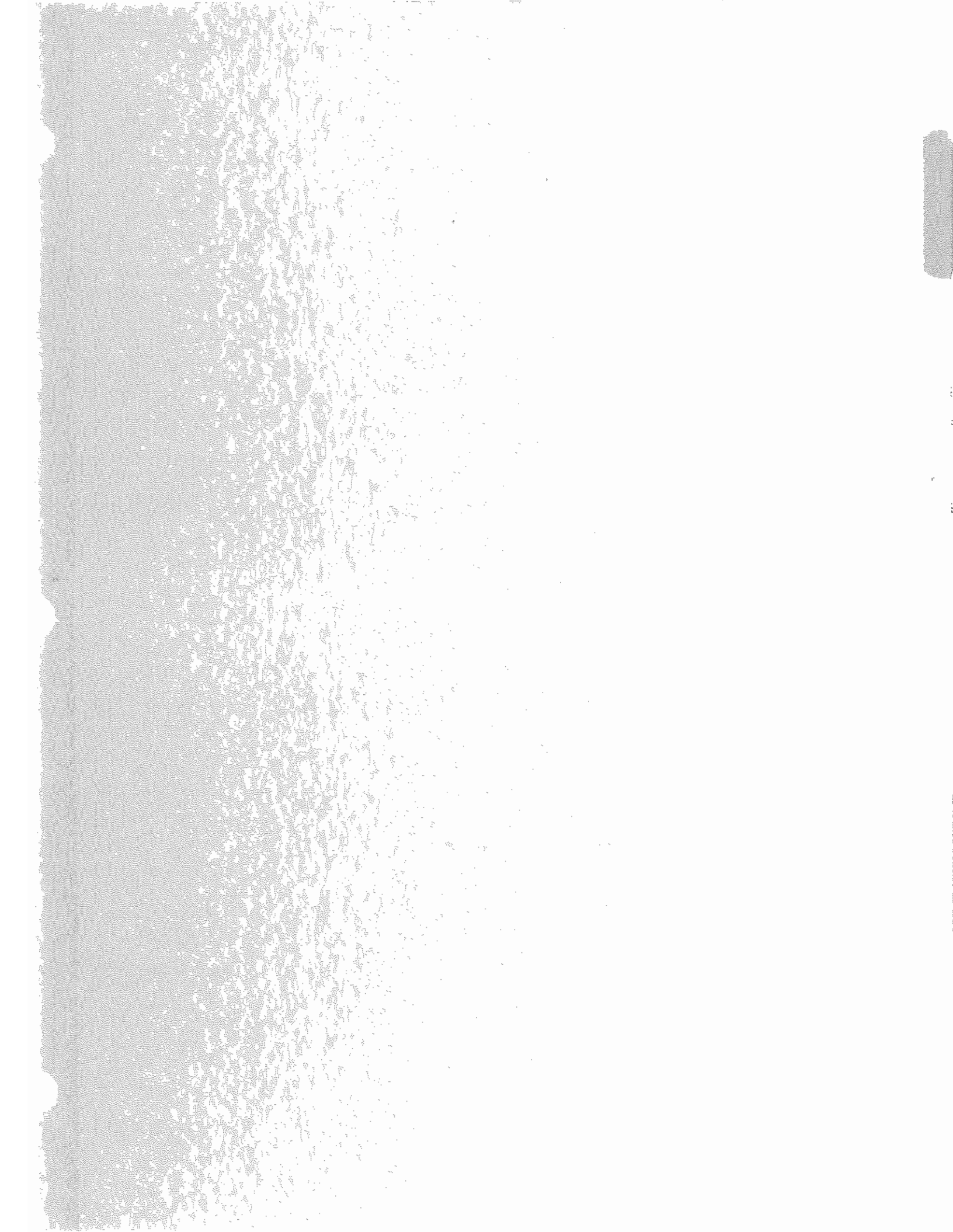

KARLHEINZ SCHREIBER  
MACKAY LAKE ESTATES  
7 BITTERN COURT  
ROCKCLIFFE PARK  
OTTAWA, CANADA  
K1L 8K0

July 6, 1990

The Rt. Hon. Brian Mulroney, P.C., M.P.  
Prime Minister of Canada  
Room 309-S  
Centre Block  
House of Commons  
Ottawa, Ontario  
K1A 0A6

Dear Prime Minister:

Let me say what pleasure it was to see you again Tuesday morning and how much I appreciated your taking the time to meet with me.

Speaking as a Canadian citizen, let me tell you how much I admire the way you have conducted yourself on the entire issue of Canadian unity and I shudder to think what condition this country would be in if anyone but yourself were at the helm.

Speaking as a friend, let me assure you of my continued support in any way I can be helpful.

I am overjoyed to learn of your coming official visit to Germany. If there is any way I can be helpful regarding this visit, please call on me. I humbly suggest that I could be helpful.

From my days with Franz Josef, I know the burdens we impose on our political leaders. But even God rested on the seventh day!

.../2

- 2 -

For that reason, I look forward to seeing you and  
your wife relax in Bavaria.

With friendship and admiration.

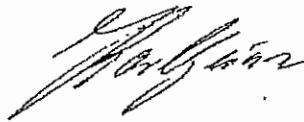
A handwritten signature in cursive script, appearing to read 'Karlheinz Schreiber', written in dark ink.

Karlheinz Schreiber

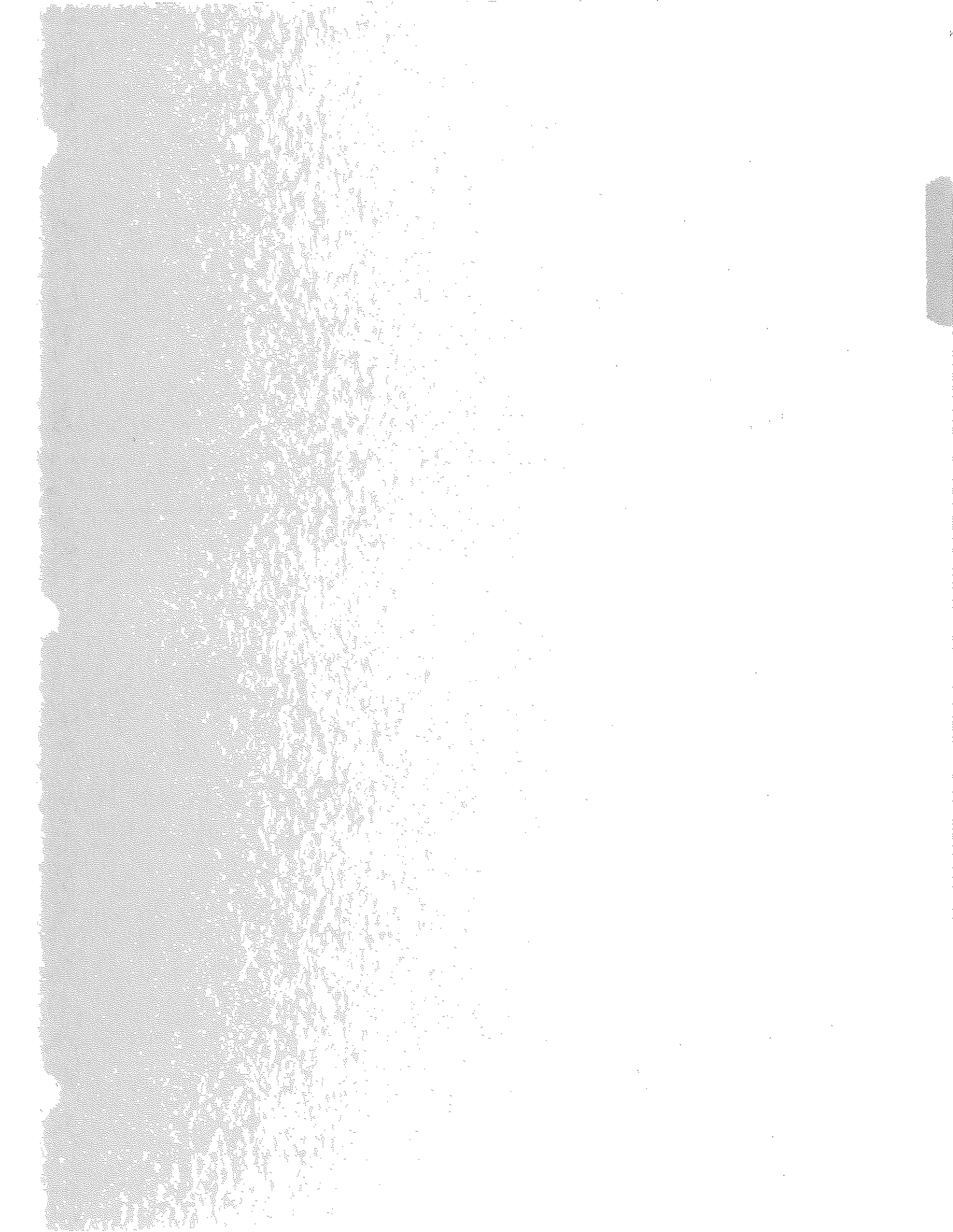

# Karlheinz Schreiber

Suite 908, 350 Sparks Street, Ottawa, Ontario  
Telephone: (613) 563-3321 Fax: (613) 563-7648

## PERSONAL CONFIDENTIAL FOR HIS EYES ONLY

27 August 1990

The Right Hon. Brian Mulroney, P.C., M.P.  
Prime Minister of Canada  
Ottawa, Ontario  
K1A 0A2

Dear Prime Minister:

First, let me thank you for the telephone conversation last week and I hope that your mother's birthday celebration was a happy event for she and all of your family. As you know, I am going back to Germany this week to celebrate with my mother on the occasion of her seventy-ninth birthday.

In an age as our mothers are, we are fortunate to celebrate every year with them.

Before my departure I wanted to pass on some information which I believe important.

The meeting which I had with Stanley Hartt and Elmer was very interesting and in my opinion it was very productive.

The visit of Winfried Haastert and his colleagues from the Thyssen Industrie AG Supervisory Board was very positive in their understanding of the promising out-look for establishing our new Canadian factory in Nova Scotia.

# Karlheinz Schreiber

Suite 908, 350 Sparks Street, Ottawa, Ontario  
Telephone: (613) 563-3321 Fax: (613) 563-7648

**PERSONAL CONFIDENTIAL  
FOR HIS EYES ONLY**

2

I passed on your regards as you had requested during our telephone conversation and this was both very appreciated and respectfully acknowledged in return.

This group has travelled onward to Los Angeles for project discussions after last week's award to Thyssen for the high speed rail link between Los Angeles and Las Vegas, selecting Thyssen's Magnetic Levitation train which will provide a 500 km/hour connection between the two cities.

Observing Canada has been among the first nations to respond to the Iraqi invasion of Kuwait, I believe it will be of interest to know I have arranged, at the request of the U.S. Government, for the immediate supply to the US forces from West German army inventory, 10 Fox NBC reconnaissance vehicles (capable of chemical detection and protected operation in a chemical warfare environment) and an additional option for 20 more of these vehicles. As you may be aware, neither Canada nor the US have any such anti-chemical vehicles in inventory.

The US has now asked for the Fox chemical protected personnel carriers as well. It now appears the U.S. may request all available vehicles. Before we agree to such a US request, I am offering to make such vehicles available to Canada should Canadian forces be deployed to a land base in a region threatened by chemical warfare.

If such is your desire, I would need to know as soon as possible.

I trust this is helpful to you.

As regards the Mohawk situation, I have been concerned for years, and have expressed this concern, about the known fact that certain Canadian Native groups received training in East German terrorist training camps, and I have reason to believe that some such groups may be in possession of armour-piercing weapons. There are in Shilo, Manitoba, at the Training Camp, a number of Marder personnel carriers vehicle, which offer protection against such weapons. They are being used for training the German forces

there. I could arrange, either from our company, or on a Nato country to country basis, to make these vehicles immediately available to your forces.



# Karlheinz Schreiber

Suite 908, 350 Sparks Street, Ottawa, Ontario  
Telephone: (613) 563-3321 Fax: (613) 563-7648

**PERSONAL CONFIDENTIAL  
FOR HIS EYES ONLY**

3

I trust this may be helpful to you as well.

Hopefully, these conflicts will be resolved peacefully, but I wanted you to know that I am available to help in this way should it be necessary.

Sincerely,

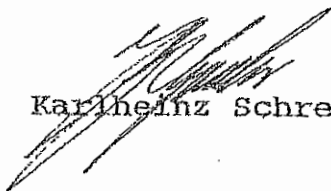

Karlheinz Schreiber

P.S. I am enclosing info on these vehicles. Obviously I am not trying to "sell" Canada anything by this offer, merely arranging to have the vehicle loaned to Canada to help protect Canadian soldiers.



**NUCLEAR, BIOLOGICAL, CHEMICAL  
RECONNAISSANCE SYSTEM  
(NBCRS)**



THYSSEN HENSCHEL

**GENERAL DYNAMICS**  
*Land Systems Division*



## WORLD CLASS TEAM

### GENERAL DYNAMICS AND THYSSEN HENSCHEL HAVE TEAMED TO MEET THE U.S. ARMY'S IMMEDIATE OPERATIONAL NEED TO COUNTER THE GROWING NBC THREAT.

Airland Battle doctrine requires continuous operations on the contaminated battlefield. The ability to quickly detect, identify, and quantify a wide variety of contaminants, coupled with the ability to rapidly communicate this information to friendly forces, could decide the outcome of the conflict. That operational capability is missing today.

An operational vehicle system that can respond to this need is available now from a proven industrial team of General Dynamics Land Systems and Thyssen Henschel.

The FOX NBC Reconnaissance System (NBCRS) is the only operational system of its kind in the free world. Thyssen Henschel has produced more than 140 FOX NBCRS configured vehicles that are currently fielded and used by the West Germany Army. In addition, over 1000 FOX combat, combat support, and combat service support vehicles have been produced and fielded to support NATO forces.

The FOX NBCRS is a highly mobile, amphibious wheeled vehicle, tailored to meet the operational requirements for NBC Reconnaissance on the current battlefield. It is the only operational NBC Reconnaissance System in use by NATO forces today.

The FOX NBCRS is already playing a key role in the defense of Europe.

Thyssen Henschel has a long history of combat vehicle development and production. Today the company designs and builds some of the most sophisticated armored combat, communications, missile, and command systems for the West German Army and other NATO allies.

General Dynamics brings the experience of decades of design, integration, and production of defense systems. GD has designed, built, and supports a wide range of advanced weapon systems including the F-16 aircraft, the Stinger Missile, and the M1 series Main Battle Tank.

The combined resources of this team has resulted in a program to provide a proven NBCRS system that meets today's requirements with planned growth for future NBC defense requirements. The proposed program offers a low risk approach, based on using an NBCRS that has been fielded and in operation since 1984.

The baseline NBCRS will be expanded during a system improvement program that is based on current Army combat vehicle command and control electronics technology as well as the latest NBC detection technology.

### TRANSITIONING NATO TECHNOLOGY INTO THE U.S. ARMY PRODUCTION BASE

The FOX NBCRS meets today's demand for a high performance armored vehicle tailored to accomplish the NBC Reconnaissance Mission.

The FOX system is fully developed and proven. The integrated Non-developmental Item (NDI) nuclear, and chemical detection, identification, location, and marking system is currently playing a role in the defense of Western Europe. The current FOX system provides a baseline for evolutionary improvement with low technical risk.

For full rate production, the FOX NBCRS will integrate all of the developed and tested

improvements necessary to provide a mobile standoff sensing capability for detecting, identifying, and reporting all NBC threats.

The improved FOX will be based on an electronics architecture that will integrate all NBC detectors, the Position - Navigation (Pos/Nav) system, and meteorological sensors, with a digital burst communications capability via an integrated computer processing unit.

System upgrades can be retrofitted to the current FOX NBCRS with no degradation to system performance or RAM characteristics.

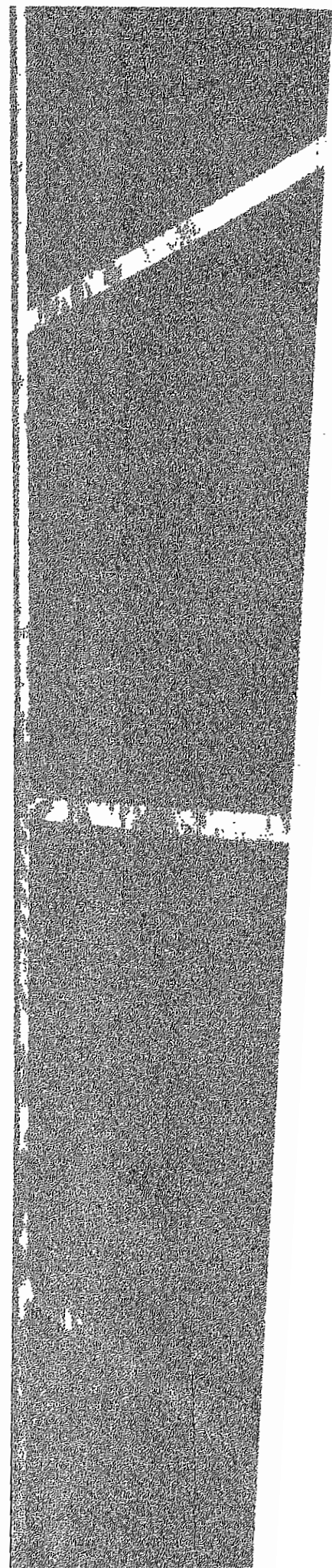
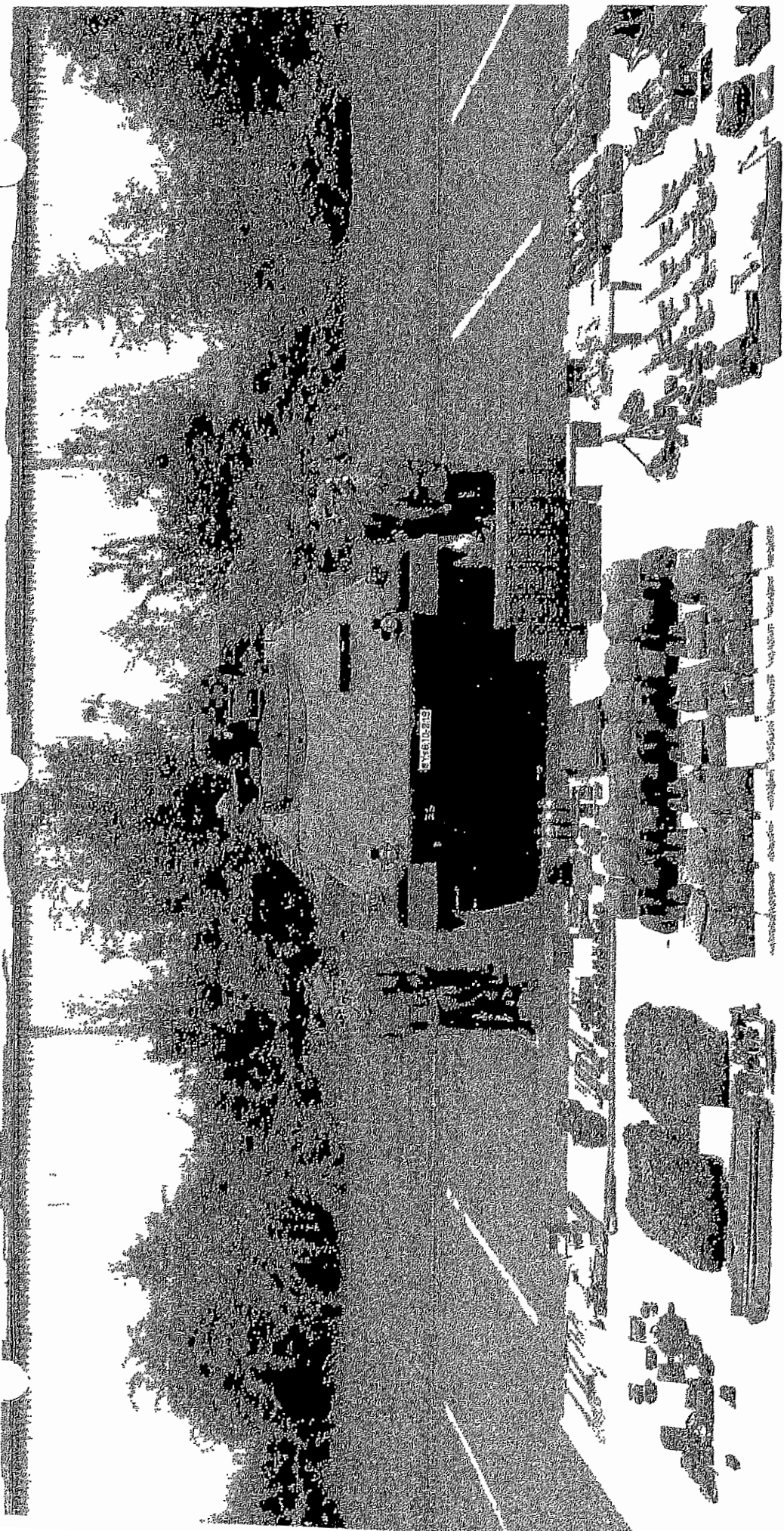

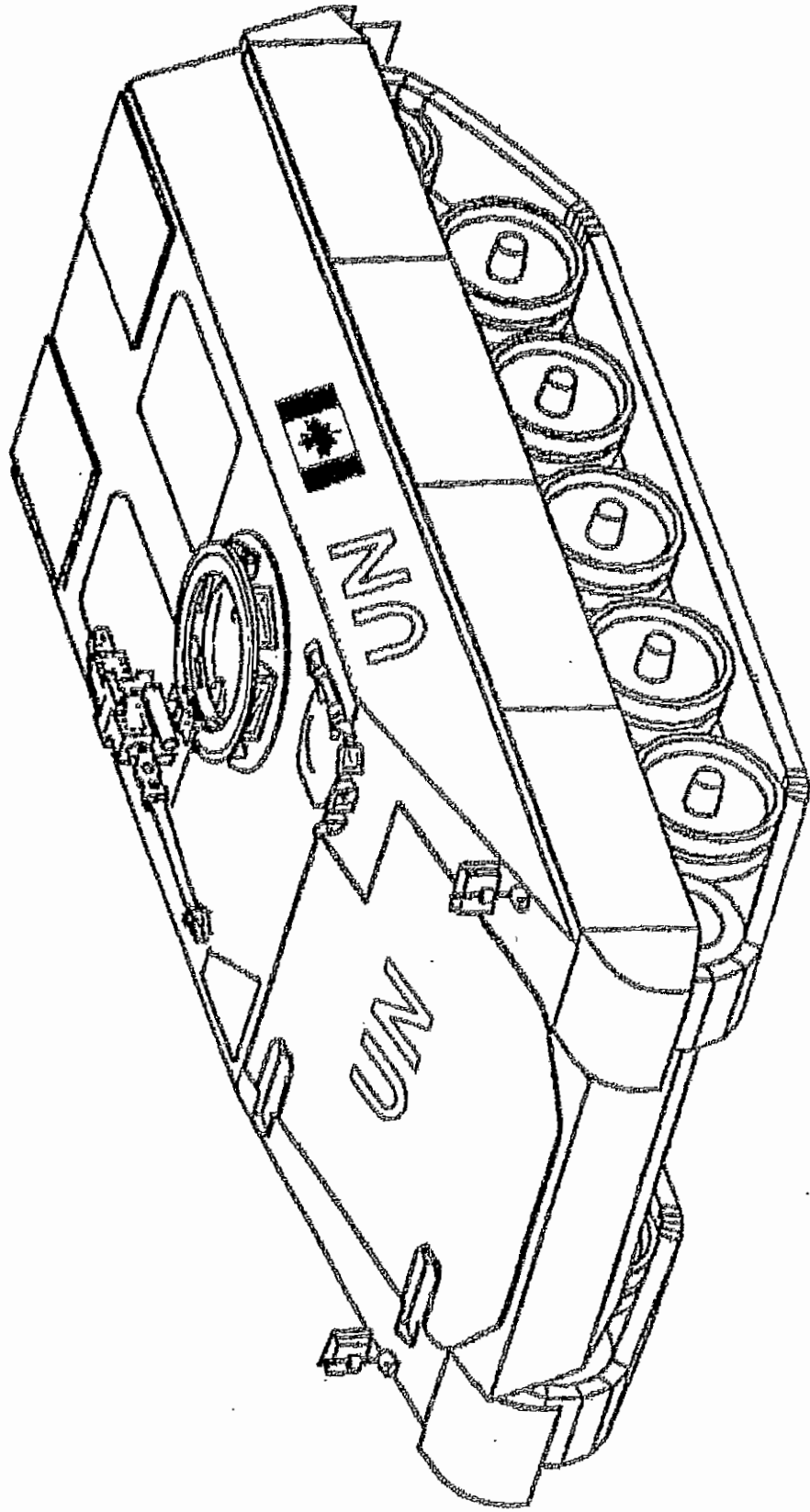

AMERICAN INDUSTRIES LTD.

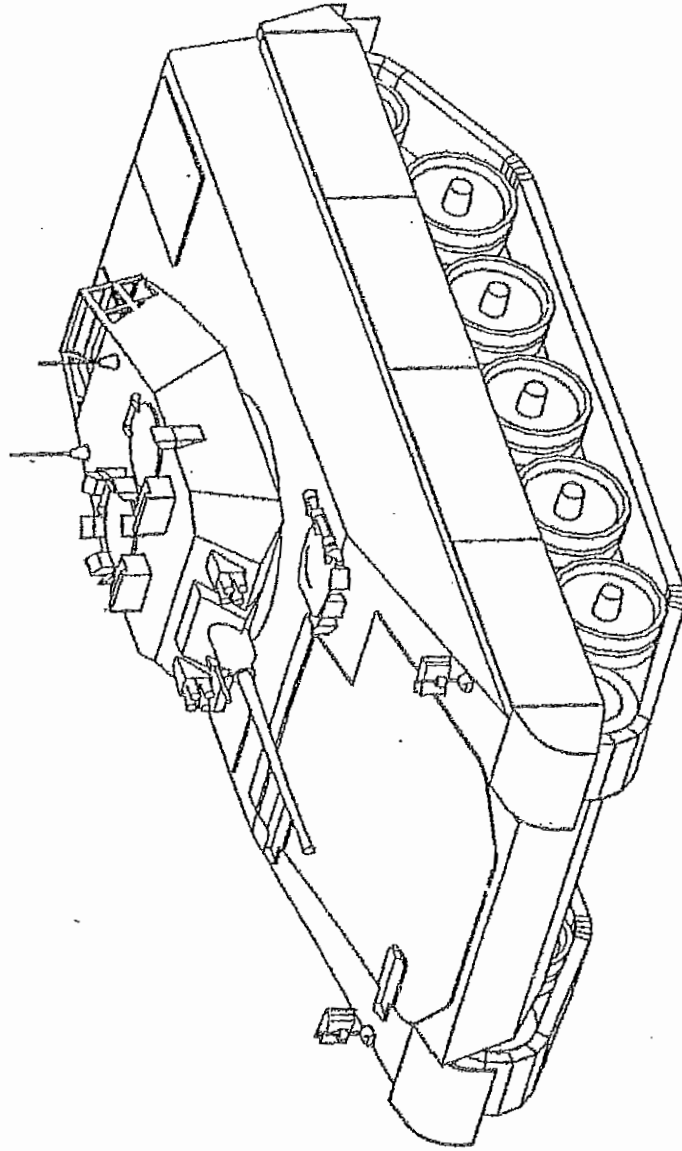

TH 495

WITH TURRET LAV 25 MM

 BEAR HEAD INDUSTRIES LTD.  
THYSGEN HENSCHEL

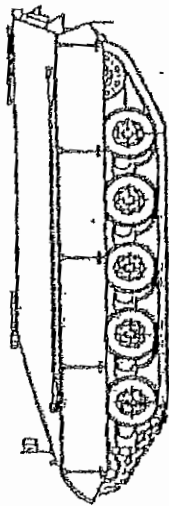

T H 4 9 5  
CARRIER

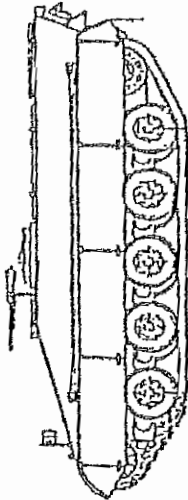

T H 4 9 5  
INFANTRY-VEHICLE, with MG 7.62 pin-mounted

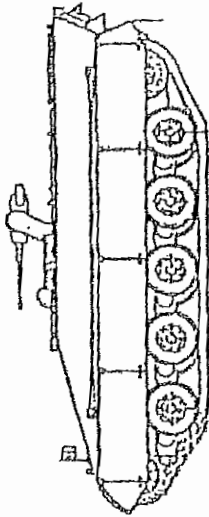

T H 4 9 5  
INFANTRY-VEHICLE, with MG 12.7 Cupola

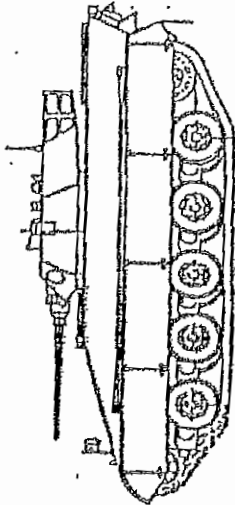

T H 4 9 5  
INFANTRY-FIGHTING-VEHICLE, with main gun 25 mm

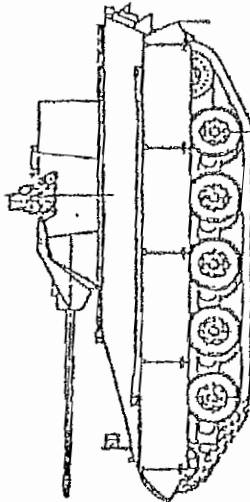

T H 4 9 5  
INFANTRY-FIGHTING-VEHICLE, with main gun 35/50 mm

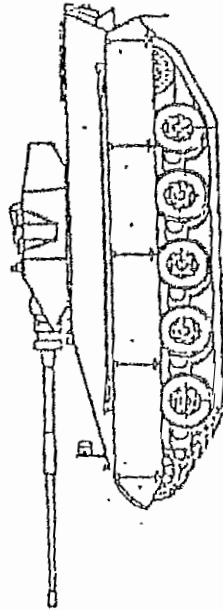

T H 4 9 5  
INFANTRY-FIGHTING-VEHICLE, with BK 60 mm

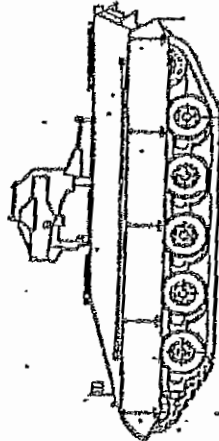

T H 4 9 5  
INFANTRY-VEHICLE, with armored launching turret for the 50W Missile System

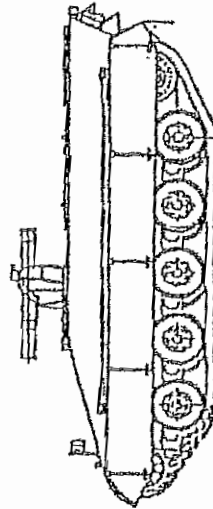

T H 4 9 5  
TANK HUNTER, with TOW-launcher





# Karlheinz Schreiber

Suite 908, 350 Sparks Street, Ottawa, Ontario  
Telephone: (613) 563-3321 Fax: (613) 563-7648

CONFIDENTIAL, FOR HIS EYES ONLY

10 October 1990

The Right Hon. Brian Mulroney, P.C., M.P.  
Prime Minister of Canada  
Ottawa, Ont.  
K1A 0A2

Dear Prime Minister:

Many thanks for the most enjoyable meeting we had last month. What a great pleasure to recognize that old friends never change.

Congratulations on your great success in New York. I would like to inform you that you have been the only conference speaker who was shown on the television in Germany and Switzerland. I received several comments from friends in Europe who applauded your remarkable statements and their plainly evident sincerity.

I wish you could see Canada from an overseas perspective, where the country is viewed at such an advanced stage of evolution that the Prime Minister can turn to the issues that are truly important to this world, such as our children, our environment and our commitment to keep peace. Witnessing your leadership in this role from Germany reminded me of this and brings me to encourage you with all of my best wishes.

Turning back to discussions of our meeting last week, I would like to share some further thoughts which I have had on those matters.

In my opinion, the greatest opportunity for Canada is to achieve growth in the export of finished products. I am most familiar with the trade between Canada and Germany and while I am delighted to find Canadian exports to Germany in 1989 increased by 20.1%, I note the largest portion of that growth has been in unfinished resources.

Karlheinz Schreiber

2

**CONFIDENTIAL, FOR HIS EYES ONLY**

Therefore, the remaining challenge is to increase the proportion of finished products. I am confident that I can help you in meeting this challenge, but before I can do this, I must have in place the right tools with which to work. I should not withhold from you the fact that I face increasing pressure due to the newest development, where earliest production is urgently required. I am not able to explain to the United States customer why their vehicles should be manufactured in Canada where we have so far found no business with the Canadian Forces.

What is needed as soon as possible is the signed MOU as proposed by Minister MacKay, to solve the aforementioned problems as well as bring new and vital long-term activities in Trenton.

Thank you, and please be assured that I will do everything I can to meet your goals.

With best personal regards,

  
Karlheinz Schreiber



**Karlheinz Schreiber**

Suite 908, 350 Sparks Street, Ottawa, Ontario  
Telephone: (613) 563-3321 Fax: (613) 563-3321

**PERSONAL AND CONFIDENTIAL  
HIS EYES ONLY!**

---

April 19, 1991

The Right Honourable  
Brian Mulroney  
Prime Minister of Canada  
Langevin Block  
80 Wellington Street  
Ottawa, Ontario  
K1A 0A2

Dear Prime Minister:

As a follow-up to our meeting of last week, I have noted a few items which I feel are important for you to be aware of.

Since you made it very clear in your statements what your principles are, and how much you care about your people and especially about the safety of your Armed Forces who serve them, I am more determined than even before to support you through pursuit of the Thyssen-BHI project.

Unfortunately, to fulfil this commitment to you, I think I have to help you to identify information which may have misled you on the Thyssen project. So far during my experience on this project, I have been frightened to think this may also occur on other initiatives.

Attached, you will find an "Aide Memoire", and comments in response to questions from the Minister of ACOA.

If you will allow me, I would suggest that you keep this all for your personal interest as I intend to table these attachments during my up-coming meetings with your officials.

I think there is no need for me to comment on the continuing meeting we had with Mr. Tellier after your departure, as I know, Fred will do this. Rather, let me lead your attention to items which you were interested in.

In your presence, Mr. Tellier told you that DND could buy the appropriate MRCV for Canadian Forces for a price of \$500,000. This is just nonsense.

Stanley Hartt showed me a report from Paul Tellier, dated August 10, 1990, in which it was stated, "Mr. McKnight is strongly opposed to this project on financial, policy and operational grounds". This cannot be true, for Bill McKnight told me several times, in the presence of Elmer MacKay, that he would love to go for the project but that he unfortunately had insufficient funding in his department.

In the same document, General Motors Diesel Division in London, Ontario is described as successfully competing in the field of armoured vehicles and has obtained an important contract in Saudi Arabia. This is not true.

From information contained in a separate document prepared by ACOA in December 1990, I was asked by Minister MacKay to respond to comments from External Affairs, stating their concern that by directing a major military purchase to a non-US (i.e. German) source, Canada will initiate US trade interests and threaten access to the US defence market.

This comment is misleading, for the entire Thyssen-BHI project was described to the Under Secretary of the US Army and received his endorsement. This meeting took place in the presence of the Minister Counsellor of the Canadian Embassy.

If there are any doubts on your side, on the statements given to you by the Company, and the merits of the proposal, the Company is prepared to submit to an appraisal of these issues by an internationally recognized authority.

Lastly, about the comments of Mr. Fowler who told us from the beginning that we "are not going to get this project" and the equally unbelievable remarks of Lt. Gen Huddleston, I will only remind you of our discussion.

As an independent individual, and your true friend, I can only tell you, that in my opinion, the Thyssen project, realized in Canada, will be the best economic and political tool, I can possibly imagine.

I would appreciate if you could find the time that I could explain all this in greater detail.

Wishing you all the best and with

Warm regards,



Karlheinz Schreiber

## AIDE MEMOIRE

1. Q: Is it in fact a stated policy of the Government to use DND Capital program spending to promote regional economic development?

A: Yes, as stated in the White Paper on Defence in June, 1987, and publicly declared Cabinet policy.

2. Q: Is it the intent of the Government to promote exports of products made in Canada, and within this goal promote the development and manufacture of products in Canada which can be successful in export markets?

A: Yes. All parties would agree that increased exports are vital to Canada's overall economic recovery, and future survival as a player in the global market.

3. Q: Is it agreed that the Canada-United States Free Trade Agreement (FTA) and Defence Production Sharing Agreement (DPSA) must be utilized as vital tools of entry to the US market by Canadian products?

A: Yes, otherwise the Mulroney Government's negotiation and implementation of the FTA is ignored.

4. Q: Should the branches of the Federal Government not support initiatives which specifically target the export market covered under the Canada-US Free Trade Agreement?

A: Yes, and the Thyssen BHI project is an example of such an initiative.

5. Q: Regarding the Army's MRCV project, relative to DND's overall program, one can observe that the Air Force is equipped with modern fighter jets, notably the CF 18, while the Navy has begun to receive their new frigates which will be followed by the NSA helicopters and the new minesweeper vessels. However, it appears the Army is left with obsolescent combat vehicles.

With this in mind, are there any significant changes to army equipment from the status described in testimony to the Senate Defence Committee, May 26, 1987 by then Commander of Mobile Command Gen. Jim Fox?

A: No, with respect to combat vehicles for the regular troops, no change has occurred.

6. Q: Did Army soldiers face the threat of injury from 7.62 AP (armour piercing)

ammunition while in their armoured personnel carriers during the "stand-off" with Native Canadians at Oka in 1990?

A: Yes, in fact the Leopard 1 main battle tank was deployed on the final approach to the barricades.

7. Q: Could Canadian soldiers also face threats as common as 7.62 AP ammunition penetrating their current armoured personnel carriers during assignments to UN peacekeeping missions, including the Gulf region?

A: Yes.

8. Q: Are the Canadian Forces presently able to deploy troops into a contaminated zone using vehicles with an integral NBC (Nuclear, Biological, Chemical) protective system?

A: No.

9. Q: Has the Canadian Army placed the Multi Role Combat Vehicle (MRCV) as their top priority in equipment requirements?

A: Yes.

10. Q: Is NATO (Nato Industrial Advisory Group - NIAG) working on a standard requirement for NATO nations along the lines of the MRCV requirements?

A: Yes.

11. Q: In light of the experience of the Gulf crisis, is this MRCV applicable to the future needs of our allies?

A: Yes.

12. Q: Are the parties involved aware that for example the German forces have no vehicle such as the MRCV suitable to their future participation in the planned NATO "rapid reaction forces", and will be seeking a new design?

A: Yes.

13. Q: Given Canada's international reputation as pioneers and leaders in the in the concept of UN peacekeeping, would a Canadian made vehicle not enjoy an ideal trade mark in the maple leaf?

A: Yes.

14. Q: Are the parties involved agreed that departure from the prospect of export potential as a necessary feature of the vehicle which is procured as Canada's MRCV may have serious negative consequences in the cost of operation and maintenance, due to the absence of inter-operability of such a vehicle among Canada's allies.

A: Yes.

15.Q: What are the essential characteristics in a peacekeeping and Multi Role Combat vehicle (MRCV)?

- A:
- 1) air transportable in the Hercules C 130
  - 2) armour protection against a minimum of 7.62 AP ammunition
  - 3) protection from biological and chemical weapons
  - 4) high mobility across a wide range of terrain
  - 5) family concept in design, to include capability for reconnaissance, infantry transport, armoured combat and other variants
  - 6) capacity for increased armour protection through in-field application of "modular add on armour", to meet threat in mid intensity conflict (eg. Gulf crisis)
  - 7) suitable for deployment in internal security role (eg. Oka, 1990)

The Thyssen proposed vehicle (TH 495) is being developed to meet these requirements.

16. Q: Is it agreed that these characteristics also meet the requirements of other armies?

A: Yes, very likely.

17. Q: If this is the case, will this not bring the Thyssen TH 495 vehicle significant export opportunity in these markets?



A: Yes.

18. Q: Is there an "off the shelf" vehicle existing from a western industrial country and selling at a price of \$500,000.00, which meets the Canadian MRCV requirement?

A: No, there is no such vehicle available for that price. Furthermore, to the Company's knowledge, no competitor is able to produce the vehicle needed to meet the Canadian MRCV requirement at the same quality and at a lesser price than has been offered.

19. Q: Is there another successful international manufacturer with an existing or developmental vehicle (which meets MRCV characteristics) who is willing to transfer their technology and the major share of future export production to Canada?

A: Unlikely.

20. Q: Moreover is there such a manufacturer who, in addition to Canadian production of this vehicle, will introduce a diversification of operations in the environmental protection sector and the variety of industrial activity similar to the Thyssen range of technology?

A: No.

If all will agree with these points made above, they will also agree that whichever manufacturer can enter the market first will secure a distinct advantage in this business.

The answers provided here are based upon internal knowledge and advice available to the Company, including our Canadian defence advisor Lt.Gen. Jack Vance (ret'd), who completed his service in the Canadian Forces in 1988 as VCDS.

To explain to those, to whom the MRCV concept is not a daily point of discussion, it is useful to observe the fundamental determinants of vehicle design which will define the elements of the end product:

Cargo door dimensions of the Hercules C 130 aircraft determine limits on a vehicles width and height

Lift capability of the aircraft determine limits on vehicle's transportation weight

Protection requirements dictate the amount of "add-on armour" and thus the operational weight of the vehicle.

Mobility requirements and the specified terrain determines the selection of power pack and wheels or tracks

After consideration of these key elements, the remaining specifications deal with equipment and systems needed to fulfil assigned rolls.

Since major assemblies and component prices are known and available within NATO, and since it is proposed to supply the vehicle on the basis of open audit - agreed profit basis, it should be agreed that there is nothing undisclosed in final costs on the vehicle.

## COMMENTS IN RESPONSE TO QUESTIONS FROM THE MINISTER OF ACOA

---

### General

- 1) The Minister of ACOA raised a series of questions and observations which had been placed to him during the December review of the Thyssen-BHI unsolicited proposal for 250 Fox vehicles, with the option of firming up the vehicle requirement over the first year. While the BHI proposal has now been altered to offer the MRCV instead of the Fox, the questions and observations raised through the Minister of ACOA were sufficiently important and contentious to merit comment.
- 2) The purpose of this paper therefore, is to clarify and comment on the various features of the BHI initiative and certain Government staff reactions to it.

### MRCV and TH 495

- 3) While staff reaction in assessing the Fox against DND plans for the MRCV was largely unfavourable, it was acknowledged that the TH 495 concept showed considerable promise.

### Financial Analysis

- 4) Project Cost  
There was considerable disagreement on the overall cost of the project. This was based on DND's assessment of a 2.5 factor to capture not only the acquisition price of the vehicle, but also the cost of running the project, buying the spare parts, and the maintenance required over the life of the vehicle, the training, instructional manuals and documentation needed to support the project, and the like. Thus instead of costing 290 million dollars for the 250 vehicles, the project would cost 2.5 times as much, ie. 725 million dollars.
- 5) While it is uncertain what all costs are captured in the DND factor, it is a matter of note, that the vast majority of equipment projects for DND are assessed at a much lower factor, only the most risky projects normally exceed a factor of 2. The current Thyssen projection of project cost for the BHI proposal is in the order of 1.3 over a 10 year life cycle.
- 6) In any event, it is the firm Thyssen-BHI intention that costs be established on the basis of "open books" and on agreed profit margin.
- 7) O+M Costs  
A major argument against the "Fox" proposal was that of purchasing new vehicles without retiring the vehicles that they replace. It was estimated that as much as \$130 million would have to be added to the DND operations and

maintenance (O+M) budget.

This argument is not applicable in light of the new Thyssen-BHI proposal, since the company would plan to produce vehicles in accordance with the DND time-table.

In fact, it can be anticipated that the longer term impact on the O+M budget would be reduced because, once the MRCV is introduced into service, it is much more likely to be less costly to maintain than the current fleet of aging vehicles which DND must now maintain.

#### 8) Inefficiencies

It was observed that there would be considerable expense incurred from the lost opportunity for economies of scale in purchasing only part of the overall requirement for new vehicles. This argument does not pertain with the Thyssen-BHI proposal to manufacture the first 250 vehicles of the MRCV overall requirement.

#### 9) Summary of Costs

The Minister of ACOA informed that the staff estimate for the original Fox proposal was \$1.1 billion (presumably arrived at by totalling the project cost at a factor of 2.5, plus extra O+M costs plus significant cost for inefficiencies). In light of the revised Thyssen-BHI proposal, now offered on TH 495, it is our estimate that the cost will be in the range of \$450 million.

#### Impact on Defence Services Program (DSP)

It was advised that the DSP did not contain funds for the MRCV until 1995 and beyond, and that a premature order would force the displacement of several other large projects. In the light of the advantages to be gained by proceeding with the MRCV now, the project warrants special funding to DND. If that solution is not possible the company would consider assisting through special funding arrangements such as bridge financing.

#### Defence Industrial Base

Government staff argued that a new military vehicle facility would only add to the existing problem of over-capacity in this industrial sector. This argument, from the company's viewpoint, is spurious in that it defends a single source concept for the company already established in this field.

Even more important, the arguments of over-capacity do not take into account the significant potential for export, which will greatly strengthen the defence industrial base.





# BEAR HEAD INDUSTRIES LIMITED

Suite 908, 350 Sparks Street  
Ottawa, Ont., Canada  
K1R7S8

TELEPHONE (613) 563-3321

TELEFAX (613) 563-7648

Right Hon. Brian Mulroney  
Prime Minister of Canada  
House of Commons  
Ottawa, ON  
K1A 0A6

May 9, 1991

Dear Prime Minister:

When we met in your office on April 10, 1991, you asked me to keep you informed of matters around our project. The copy of the letter that I now enclose is intended to do that.

As you will sense readily, I continue to be astonished. I recall very well our breakfast meeting, when you told me how difficult it is to get things done. I understand the meaning of that statement more every day.

Yours sincerely,

Karlheinz Schreiber  
Chairman

Enclosure

*P.S. I trust your matter is finding a fast recovery.*



## Karlheinz Schreiber

Suite 908, 350 Sparks St., Ottawa, Ont. K1R 7S8  
Telephone: (613) 563-3321 Fax: (613) 563-7648

May 6, 1992

The Right Honourable  
Brian Mulroney  
Prime Minister of Canada  
Langevin Block  
80 Wellington Street  
Ottawa, Ont.  
K1A 0A2

Dear Prime Minister:

I would like to thank you very much for finding the time to meet with me yesterday especially when you are so busy with the constitutional issue. I was also greatly heartened by your sympathetic understanding of the situation and your determination to set things in train.

As you recommended, we are now working on a 2 page summary of the actions necessary to realize the project as you would like to see it. To deliver the exact figures will take a few days and we will present them to you next week. The activity we will engage in the next few days includes an investigation of the situation for establishment of the project in East Montreal.

I would also like to inform you that after the meeting with you, Elmer and I had a very good meeting with Marcel Masse and I expect to meet with him again next week.

With regard to your suggestion that we get together when you are in Munich, perhaps you would ask one of your staff to give me information on your program, so that my family and I can help you and your family to enjoy your visit to our home city.

I look forward to seeing you again next week.

Warm personal regards,







## Karlheinz Schreiber

Suite 908, 350 Sparks St., Ottawa, Ont. K1R 7S8  
Telephone: (613) 563-3321 Fax: (613) 563-7648

13 May 1992

The Right Honourable  
Brian Mulroney  
Prime Minister of Canada  
Langevin Block  
80 Wellington Street  
Ottawa, Ont.  
K1A 0A2

Dear Prime Minister:

Subsequent to our meeting of last week and the meeting with the Hon. Marcel Masse, I am pleased to inform you that I have now had very encouraging meetings with representatives of the Premier and officials from the Province of Quebec, and with four senior Army Generals.

The next important step in the whole process is to have a meeting as early as possible with l'Hon. Marcel Masse to discuss the areas of his very important involvement. A letter to Minister Masse is attached which will inform you of that proposal.

I will keep you informed on our progress, and will request a further meeting when the situation is more fully advanced. I know that I can count on your continuing support, although I appreciate that all our activities are greatly overshadowed by the tragic event in Nova Scotia, and Elmer's strong personal concern and involvement.

Sincerely yours,

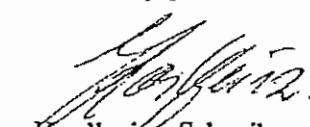

Karlheinz Schreiber  
Chairman



## THYSSEN BHI

Suite 908, 350 Sparks Street  
Ottawa, Ont., Canada  
K1R 7S8

TELEPHONE (613) 563-3321

TELEFAX (613) 563-7648

May 13, 1992

Hon. Marcel Masse  
Minister of National Defence  
Confederation Bldg. #209  
House of Commons  
Ottawa, Ontario  
K1A 0A6

Dear M. Masse:

Following last week's meetings with the Prime Minister, the Hon. Elmer MacKay and with you, we proceeded as discussed. Due to the tragic disaster in Nova Scotia, Elmer has not been able to keep you informed of events since. Therefore, I will fill in for him to bring you up to date.

As we informed you, our next steps were to meet with officials of the Province of Québec and with some of your Army Generals.

With respect to our discussions with the Province of Québec, we have found a very enthusiastic reception in meetings with the Premier's staff and officials from his Department of Industry, Commerce and Technology. On behalf of Premier Bourassa, they have expressed their support for our proposal and are now actively assessing potential sites in the Montreal area for our consideration.

We also met with four of your Senior Army Generals who share the view of the global nature of the requirement wherein allies will need vehicles of the type identified in your recently suspended MRCV program. The discussions with them underlined your views of the growing importance of future peacekeeping, as written in your April Statement of Canada's Defence Policy, 1992.

Thyssen Henschel is now proceeding with one of first prototypes of a new family of light armoured vehicles. These initial prototypes are based on the TH 495 design which was



THYSSEN BHI

2

originally conceived in response to the requirements of various NATO allies, including recognition of the essential Canadian MRCV requirement as advised to industry through the German Defence Attaché on April 1991 and confirmed by you in your letter to the German MOD February 10, 1992.

To successfully complete development and to allow Thyssen and Canada to participate in the anticipated large export and co-production potential, we are extremely anxious to incorporate acknowledged Canadian peacekeeping expertise through advice from Canadian Forces operational and technical experts.

Therefore the action I am proposing will require a development contract with DND. This will permit the fabrication of eight prototypes, five in a new facility in Montreal. These latter vehicles will be furnished to DND for evaluation.

The cost of the entire contract will amount to \$132 million (CY) spread over three years. It is recognized that these funds will have to be found from other sources beyond current DND allotments and that DND's participation will be reimbursed. To avoid any misunderstanding, I wish to point out very clearly that the project under discussion has nothing to do with future vehicle procurement for the Canadian Forces.

You must understand that I cannot proceed as agreed with the Prime Minister to organize the necessary funding, nor can a draft contract be proposed until you and I have reached agreement through a Memorandum of Understanding.

I look forward to meeting with you at your earliest convenience, as agreed last week, to discuss the next necessary steps to bring this project to fruition.

Sincerely,

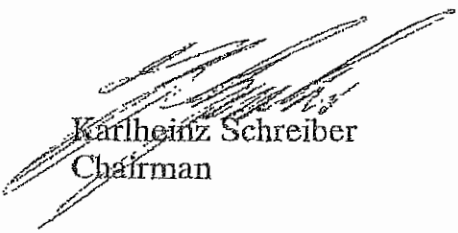

Karlheinz Schreiber  
Chairman

cc: Rt.Hon. Brian Mulroney  
Hon. Elmer MacKay

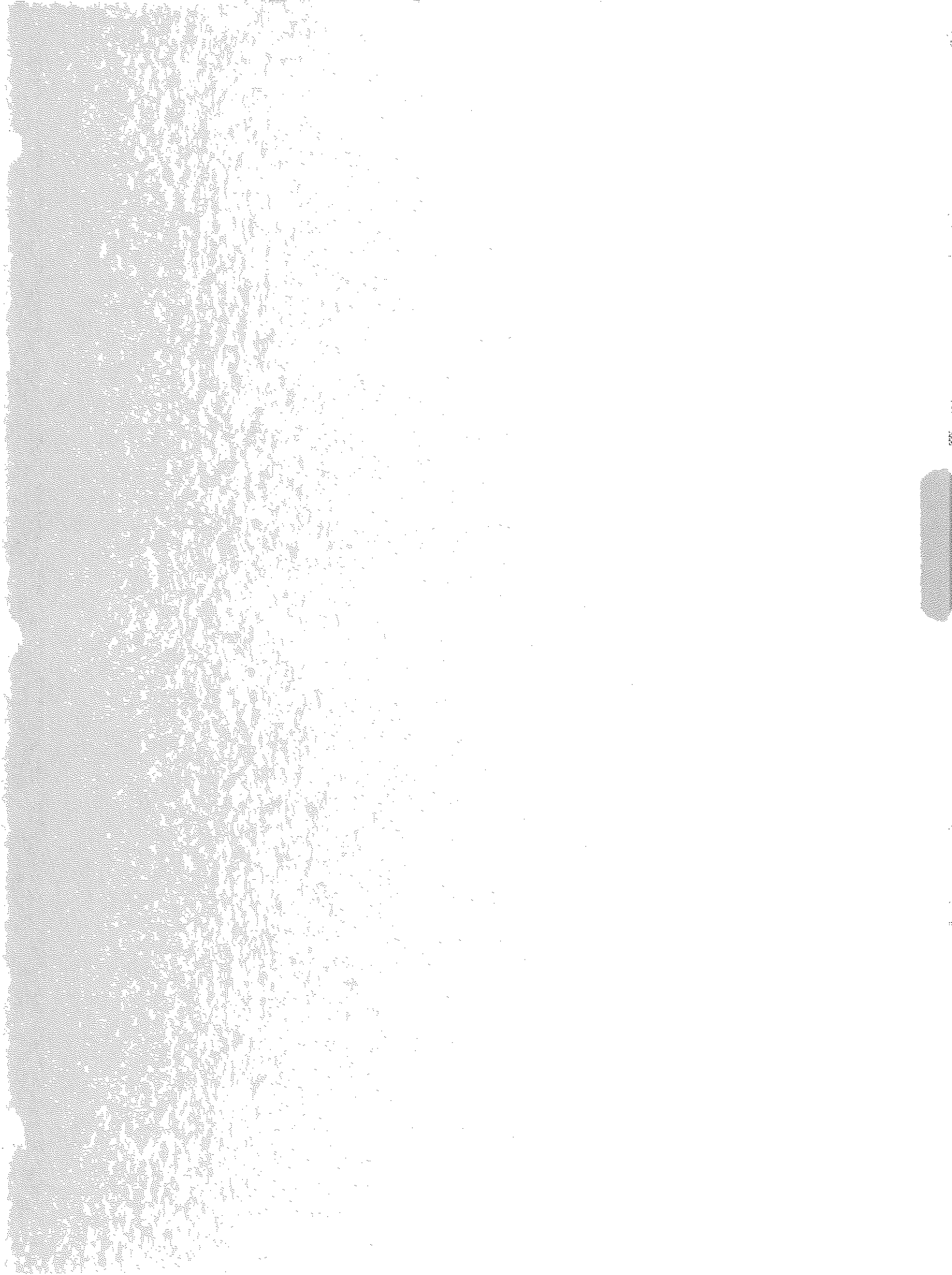



## BEAR HEAD INDUSTRIES LIMITED

Suite 908, 350 Sparks Street  
Ottawa, Ont., Canada  
K1R 7S8

TELEPHONE (613) 563-3321

TELEFAX (613) 563-7648  
TELEX 053-3981 bhi ott

The Right Honorable  
Brian Mulroney  
Prime Minister of Canada  
Langevin Block  
80 Wellington Street  
Ottawa, Ont.  
K1A 0A2

22 May 1992

Dear Prime Minister,

As promised I write to keep you informed of recent events which have occurred as I proceed to realize our project by the method which I agreed with you during our last meeting.

I am pleased to confirm the very positive support we have received for our proposal from Hon. Jean Corbeil as expressed through M. Richard Le Lay his Chief of Staff. Furthermore, I understand that it is intent of Min. Corbeil to solicit the support of Min. Benoit Bouchard.

That position fits in parallel with support expressed by the Province of Québec and I find it encouraging.

More recently, as a result of my May 13, 1992, letter to Min. Masse, a delegation from our Company was invited on May 20th to discuss the involvement being requested of DND by the Company.

The outcome of that meeting was completely unhelpful and I am dismayed by the lack of co-operation and understanding of the important economic benefits which this proposal offers to Canada. You will see by the attached report of the meeting that the DND position has been to simply "stone-wall" the Company's proposal. Though not a complete surprise, it was even more negative than I expected.

I have travelled to Germany for this week but will be back in Ottawa on May 31st. to resume my activity towards our project.

Most sincerely,

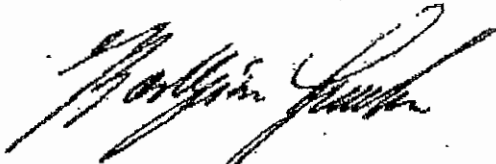

Karlheinz Schreiber  
Chairman

Encl.





## Karlheinz Schreiber

Suite 908, 350 Sparks St., Ottawa, Ont. K1R 7S8  
Telephone: (613) 563-3321 Fax: (613) 563-7648

December 3, 1992

The Right Hon. Brian Mulroney  
Prime Minister of Canada  
Langevin Block  
80 Wellington Street  
Ottawa, Ont.  
K1A 0A2

Dear Prime Minister:

First I want to thank you for providing me the great honour of again being a guest at your home for a most delightful breakfast and constructive discussion.

Bärbel and I do very much look forward to the opportunity when we can host you and Mila in one of our homes, so that we may return your kind hospitality.

Enclosed you will find the promised "Echinaforce" from the renowned Dr. A. Vogel company of Switzerland. This herbal extract is the "secret weapon" of the medical doctors in Europe. As I mentioned, the medicine boosts the strength of the human immune system. I can confirm to you that my family is using this product and we are excited about the results. This particular medicine was obtained in Ottawa, and if you are interested you will find a whole line of Dr. Vogel products at the health food store the "Wheat Berry" at 206 Main Street. If you encounter any problems with obtaining the Echinaforce, please contact my office at 563-3321.

Thank you for asking David McLaughlin with overseeing the progress of the Thyssen BHI proposal on your behalf.

Also I have had a very constructive discussion with l'hon. Jean Corbeil, and I wish to express to you the confidence which I have in his support and involvement.

As December is already here, let me sign off with best wishes to you, Mila, and the children for a healthy and happy Christmas and New Year.

Best personal regards,

  
Karlheinz Schreiber

*and warm wishes to you and your family from Bärbel.*

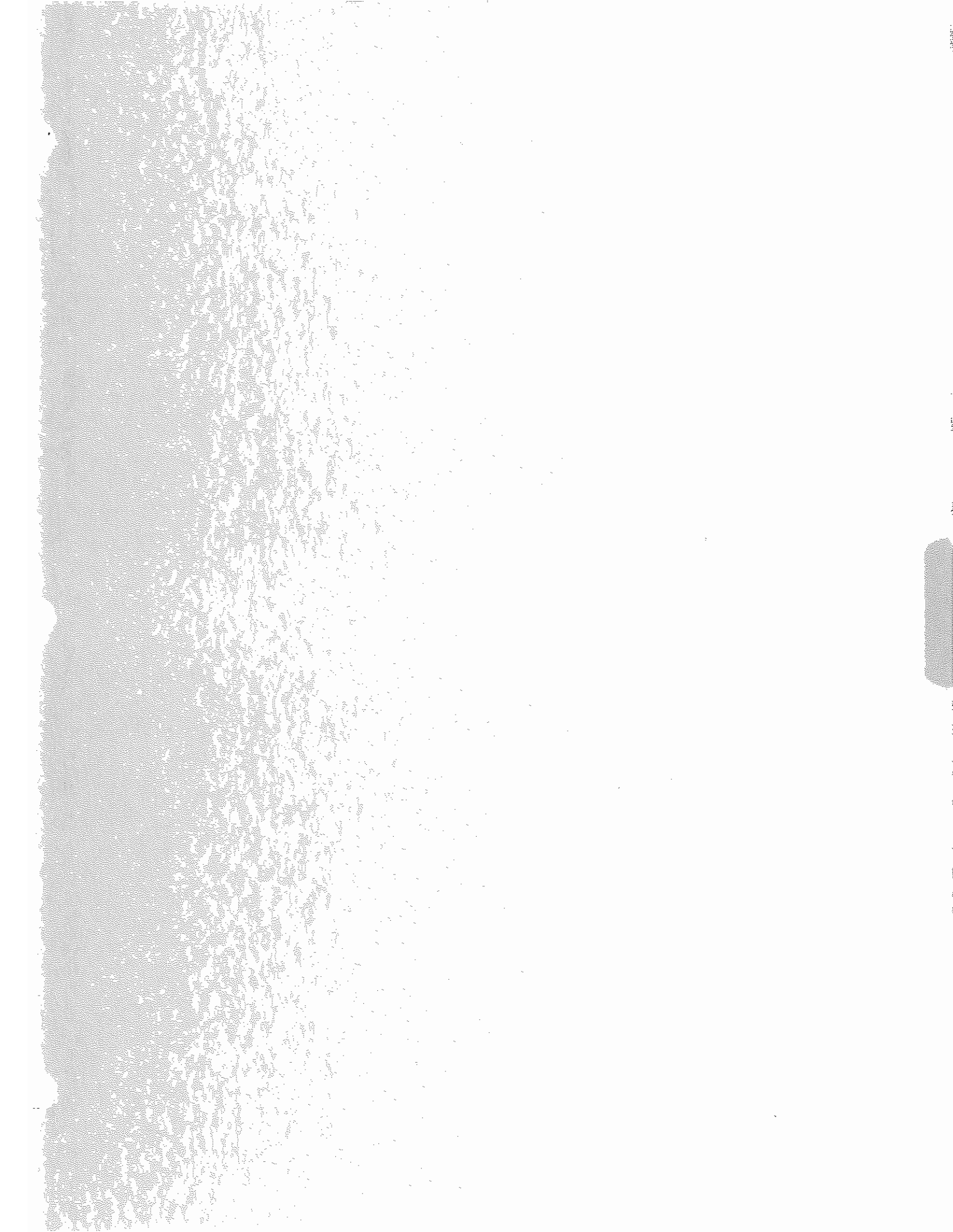

## Karlheinz Schreiber

Sulte 908, 350 Sparks St., Ottawa, Ont. K1R 7S8  
Telephone: (613) 563-3321 Fax: (613) 563-7648

March 15, 1993

Dear Prime Minister:

Arriving back to Canada, I don't want to miss the opportunity to send you this letter, expressing my feelings of sadness about the political developments in Canada since we last met over breakfast at your house.

I believe history will prove that no Canadian Prime Minister can avoid the constitutional issue so long as it is not solved. Personally, I would like to thank you for all your efforts to keep the country together for a better future in Canada. It was with greatest respect I note that no trail was too rough for you in your pursuit of a constitutional accord.

Since our birthdays are again near on the horizon, this occasion might be the right moment in our age to look at our lives retrospectively. I am convinced that when you consider the last ten years, you might be amazed at how fast time ran while your shoulders were burdened with the responsibilities of one of the most important nations in the world. I truly hope that the future will hold a destiny of comfort and happiness for you and your charming wife and children, and bring you the opportunity to spend more time together as a family.

Without doubt, you are also sure to soon find out who your real friends are. I feel comfortable to know a few of them. Keep in mind that two of them live partly in Bavaria, expecting that Mila and you may soon find the time to travel the so called "Romantic Road", which passes our home. Don't you think it would be a good idea to see us there and allow us to extent a little Bavarian hospitality?

Warm personal regards;

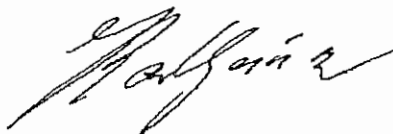



# Karlheinz Schreiber

Suite 908, 350 Sparks St., Ottawa, Ont. K1R 7S8  
Telephone: (613) 563-3321 Fax: (613) 563-7648

PERSONAL AND CONFIDENTIAL

1/4

March 16, 1993

The Right Honourable  
Brian Mulroney  
Prime Minister of Canada  
Langevin Block  
80 Wellington Street  
Ottawa, Ont.  
K1A 0A2

Dear Prime Minister:

For more than thirteen years I have had the privilege to call you my friend. In all of those years you always gave me the feeling of confidence that I could count on you, as you know you always could with me.

For nearly thirty years, I worked closely with my friend Franz-Josef Strauss; and it was not always easy to confront him with realities that he did not like. Living with the understanding that we shared a certain degree of intelligence we agreed that the greatest treasure between friends is the truth. That includes that true friends are aware that it would never be their intention to embarrass or to influence on unreasonable grounds. Keeping this in mind and looking at the situation in Canada, I have come to the conclusion that the philosophy "wash me but don't make me wet" is not going to work any longer.

If it is your understanding that Kim Campbell is the best choice to be the next Prime Minister

Attachment: File Separately. 8

# Karlheinz Schreiber

PERSONAL AND CONFIDENTIAL

2/4

for Canada, with the capability to solve the enormous problems of the country, then it is my opinion that she should resign as Minister of Defence as soon as possible. The reason I say this is because I believe the pressure and problems she may face with the Ministry may harm her chances. I don't want to deal with the problems she may face with the anti-submarine helicopter, rather I put much more importance on the safety of Canadian soldiers in Yugoslavia and in other peacekeeping missions.

The strong feeling of friendship toward you tells me that I owe you the following report on the situation as I see it:

Today, Lewis Mackenzie (MGen Ret'd) in his first speech after his official retirement from the Canadian Armed Forces spoke out frankly and honestly without editorial control from the Department of National Defence. He spoke about the state of inadequate armoured protection of Canada's armoured personnel carriers, which he experienced first hand. He specifically criticised the cancellation of the Army's requirement known as the Multi Role Combat Vehicle (MRCV) as a primary reason for the inadequacy of equipment for Canada's soldiers who are the ones exposed to the very real and serious risks of peacekeeping.

You may also be aware of the ongoing hearings of the House of Commons Committee on National Defence and Veterans Affairs, where on the 17th of February 1993, during the appearance of Adm. Anderson, Chief of Staff to the Canadian Forces, it was confirmed by his technical assistant, LCol Peter Kenward, that the M-113 and the Grizzly and Cougar (basically all of Canada's Armoured Personnel Carriers) only have protection against 7.62 mm ball ammunition, which leaves them vulnerable to the commonly used 7.62 mm armoured piercing ammunition, and most varieties of machine gun ammunition.

You may already have known of the problems with Canada's armoured vehicles from the CBC's Journal of June 22, 1992 when they interviewed Canadian troops in Yugoslavia who when discussing the state of their armoured personnel carriers told The Journal "the bullets from one of their own guns can go through one of these things like butter and it's all the protection they have".

As far back as May 26, 1987, in testimony to the Senate Committee on National Defence, LGen J.A. Fox, Commander Mobile Command, described the desolate state of Canada's

# Karlheinz Schreiber

PERSONAL AND CONFIDENTIAL

3/4

armoured vehicle fleet in comparison to the vehicles of the Warsaw Pact then and also in comparison to Canada's allies.

The German Ministry of Defence provided us with samples of the aluminum plate of an actual M-113 armoured vehicle which had been fired on and completely pierced by a basic 7.62 mm armoured piercing round. You will recall that I showed you those samples when we met at 7 Rideau Gate together with the Hon. Elmer MacKay. As a reminder of this I enclose a photograph of the pierced aluminum plate (1.75" thick) and the 7.62 ball and armoured piercing ammunition samples. I also informed the Hon. Bill McKnight, then Minister of Defence of this situation, and later did the same with the Hon. Marcel Masse when he was the Minister of Defence as well Mr. Fowler, Deputy Minister of National Defence.

In a letter dated February 10, 1992, Canadian Ambassador Delworth, on behalf of the Minister of National Defence, informed the Ministry of Defence in Germany of the pending Army project known as the MRCV, within which the lead procurement would be the RCV (Reconnaissance Combat Vehicle): "The armoured reconnaissance vehicle, RCV, must be equipped with an armour resistant against 30 mm piercing ammunition".

On April 7, 1992 in a Department of National Defence News release, we learned that GM Diesel Division was selected on a sole source basis to produce up to 229 light armoured vehicles "enhanced for the reconnaissance role". Without doubt, this vehicle will be unable to meet the stated armament requirement for resistance to 30 mm armour piercing ammunition and it is unlikely that it will achieve any higher level of protection than the Canadian Army has in the GM vehicles of the same design which they already have.

Finally, I would like to inform you that Norwegian and French Forces refused to send their soldiers to Yugoslavia with protection less than 12.7 mm (50 calibre) armour piercing. Canada is present especially in Yugoslavia now with nowhere near that level of protection. The constant threat is that Canadian peacekeepers in their outdated armoured personnel carriers could be killed by crossfire of rifles which use basic 7.62 armour piercing ammunition prevalent in the Yugoslav conflict.

With this situation, I cannot comprehend why Canadian DND will not accept a loan of

# Karlheinz Schreiber

PERSONAL AND CONFIDENTIAL

4/4

appropriately protected equipment from their German ally especially when at present the German Forces cannot participate in the peacekeeping missions in Yugoslavia. Nevertheless, the American and British Forces were not too proud to accept such a loan from Germany of the NBC Fox reconnaissance vehicles during the Gulf crisis. I was heavily involved in the arrangements to supply those vehicles to the Americans, within 48 hours of their request.

I have no doubt that you share my real concerns on the situation of our Canadian soldiers in Yugoslavia. The question is no problem for those who are not involved or are not aware of the risk Canadian soldiers face, but we are and we know, therefore, I feel guilty that I may not have done all I could to protect those soldiers who take such risks for the preservation of peace. Let's pray that Canadian soldiers are not killed as a result of their poor equipment, because the blame for their death will rest on the inaction of the Canadian Government in not providing them with adequate equipment. Almost certainly that blame will fall on the shoulders of Mrs. Campbell, and she has had virtually no involvement in allowing this situation to go unaddressed.

If you feel that I could be of any assistance to help solve the problem, please feel free to call on me at any time.

Best regards,



Karlheinz Schreiber





TH 495

Date: 08. May 1992

No.

Figur 2: Comparison of Projectiles



7,82 mm x 52  
Ball

$m_g = 9,4 \text{ g}$

$v_0 = 796 \text{ m/s}$

7,82 mm x 52  
AP

$m_g = 9,8 \text{ g}$

$v_0 = 816 \text{ m/s}$

14,5 mm x 114  
AP / B641

$m_g = 84,4 \text{ g}$

$v_0 = 976 \text{ m/s}$

30 mm x 173  
AP

$m_g = 423 \text{ g}$

$v_0 = 1000 \text{ m/s}$

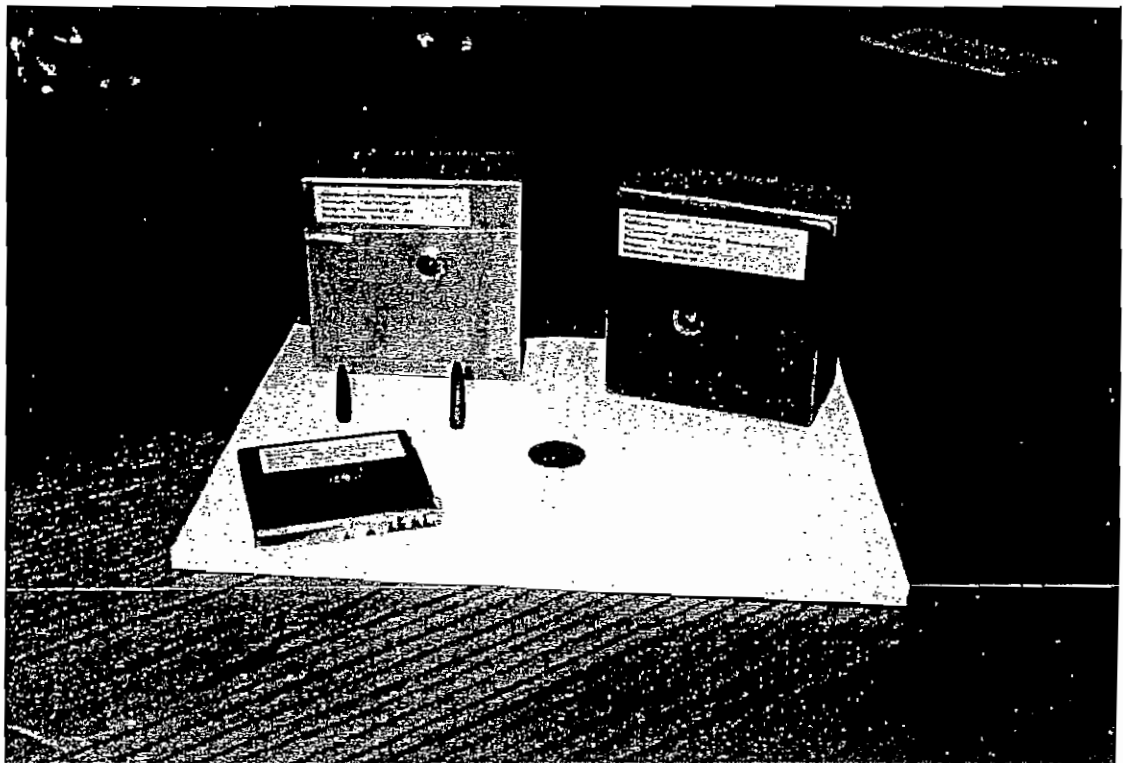
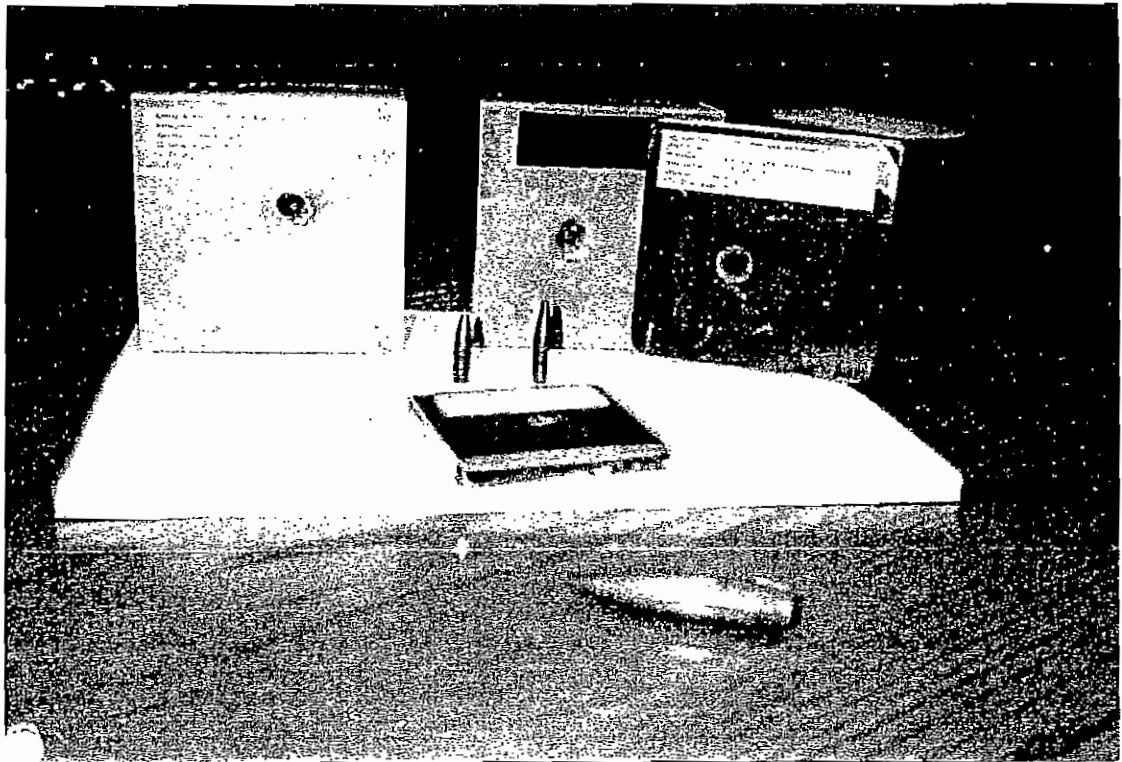



# Karlheinz Schreiber

Suite 908, 350 Sparks St., Ottawa, Ont. K1R 7S8  
Telephone: (613) 563-3321 Fax: (613) 563-7648

## PERSONAL AND CONFIDENTIAL

March 23, 1993

The Right Honourable  
Brian Mulroney  
Prime Minister of Canada  
Langevin Block  
80 Wellington Street  
Ottawa, Ont.  
K1A 0A2

Dear Prime Minister:

I refer to my letter to you of March 16, and an article in the March 22nd Globe and Mail on the same subject. I truly believe the situation both of these items refer to is of great concern for the Canadian Government.

For years I tried, unsuccessfully, to get the attention of DND on this subject, and therefore I have little confidence that the hierarchy at DND, "the second Government of Canada" is willing or able to solve the problem. I would like to suggest a way to solve the immediate problem in the easiest way.

There was never a better relationship between the Canadian and German leaders as exists today between yourself and Chancellor Kohl. The most efficient solution would be for you to call Chancellor Kohl and ask him to provide a loan to the Canadian peacekeeping forces in the former Yugoslavia with the German MICV Marder 1A3, which is a most effective and heavily armoured vehicle in the armoured personnel carrier class. (This same vehicle was referred to by the Commander of the Army during his testimony to the Senate committee on National Defence in 1987.)

# Karlheinz Schreiber

## PERSONAL AND CONFIDENTIAL

2

It is my knowledge that the Canadians have two battalions in the former Yugoslavia, therefore you would require between 100 and 150 vehicles, which would not be difficult for the Germans to supply as the German Forces have more than three thousand Marders in inventory. I am convinced that the German Government would be pleased to contribute in this way to the UN peacekeeping effort, especially when it involves protecting the lives of their allied Canadian soldiers. (Keep in mind that it took me only 48 hours to arrange the loan of Fox vehicles for the Americans during the Gulf crisis.)

I am enclosing for your information a photograph and some information on the Marder vehicle. I also enclose information on the GM Grizzly and Cougar, and the FMCM 113, where you can easily see the difference.

If you think that I could be of any further assistance to you, please don't hesitate to call on me.

Warm regards,

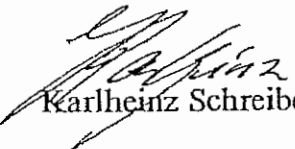
  
Karlheinz Schreiber

P.S. If you seek advice from DND, don't forget to include direct contact with the Army Field Commander

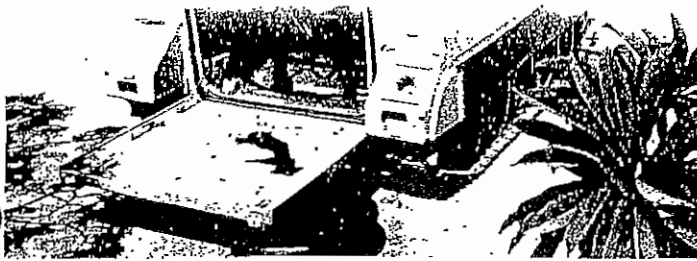

*Egyptian M113A2 APC fitted with Soviet 120 mm mortar showing baseplate stowed on rear of ramp*

The FMC vehicle completed field-testing at Camp Pendleton, California in 1985 and is currently in full operation with its aluminium-hulled counterparts. A significant feature of the FMC vehicle is a 5 to 10 dB reduction in interior crew compartment noise relative to a standard aluminium-hulled M113 vehicle.

### Thyssen Henschel Appliqué Armour

Thyssen Henschel has developed an appliqué armour kit for the M113 APC which weighs a total of 650 kg. When fitted the armour provides the following protection:

Hull front

040614.5 mm projectiles at a range of 100 m

20 mm (DM 43) projectiles at a range of 200 m

Hull sides

040614.5 mm projectiles at a range of 100 m at an angle of 45°

20 mm (DM 43) projectiles at a range of 200 m at an angle of 35°

### Mecanique Creusot-Loire Add-on Armour

Mecanique Creusot-Loire has developed an add-on armour package for the M113 that can be easily installed or removed from the vehicle using onboard tools. Some panels are fixed while others are removable for access for maintenance. The amphibious characteristics of the basic M113 are not changed. Three kits have been developed. One gives complete protection against penetration from 14.5 mm AP rounds at a range of 300 m through an angle of 180°, this kit weighs 445 kg.

The second kit provides protection against 12.7 mm AP rounds fired from a range of 100 m through an arc of 140° and against 20 mm AP and 23 mm AP rounds fired from a range of 200 m through an arc of 90°. Total weight of this kit is 830 kg.

The third kit, still under final development, provides protection against RPG-7 anti-tank weapons with HEAT warheads.

### Giat Industries Armour Package

Giat Industries of France is now offering an add-on armour package for the M113 family of vehicles to provide increased protection against 14.5 mm and 20 to 23 mm attack. The package comprises panels of special hard steel that are attached to the front, sides and rear of the vehicle.

These provide complete protection through a full 360° arc from 14.5 mm rounds fired at a range of 100 m from the KPV heavy machine gun.

Over the frontal arc the Giat Industries add-on armour provides protection

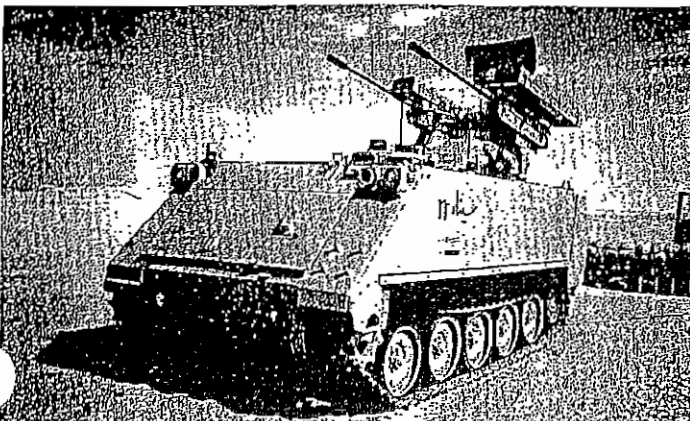

*One of the prototypes of the Dassault Electronique ESD twin 23 mm self-propelled anti-aircraft systems designed to meet requirements of Egyptian Army*

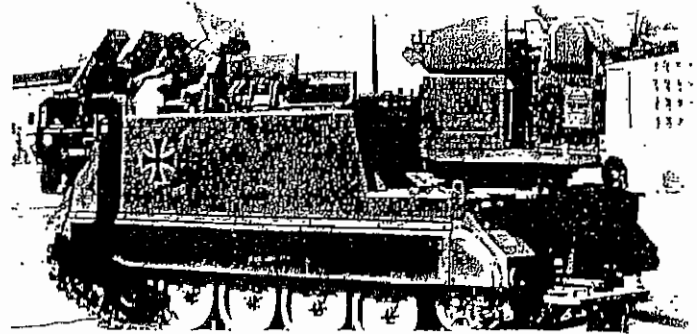

*German M113 APC fitted with Green Archer mortar-locating radar in operating position (C R Zwart)*

against 20 mm or 23 mm armour piercing projectiles fired from a range of 200 m through an arc of 90°.

The armour package is of modular construction so that individual modules can be removed if required. The total weight of the kit depends on the version, for example the basic kit weighs 650 kg while the version that includes a false floor weighs 950 kg.

When fitted with the kit, the overall width of the M113 is increased to 2.84 m while the power-to-weight ratio is slightly reduced. The top speed of the vehicle is not affected by the installation of the package.

### Other Armour Systems for M113

In addition to the Creusot-Loire and Thyssen Henschel armour packages for the M113 series already described, a number of other companies also offers such packages, these include Rafael and Urdan of Israel, LASAR of Italy and Cerachoc of France.

### M113 with Bofors RBS 70 SAM

Bofors of Sweden has developed a kit which enables a standard M113 series APC to be fitted with its RBS 70 SAM system on a pedestal in the rear troop compartment. This was announced in 1988 and is now understood to be in service with the Pakistani Army with the conversions being undertaken locally.

### M113 with 120 mm Mortar

In 1987 an M113A2 was fitted with a turret-mounted 120 mm breech-loaded mortar and demonstrated in the UK. The mortar is aimed, loaded and fired under complete armour protection. This system is still at the prototype stage.

The turret and 120 mm breech-loaded mortar has been developed as a private venture by Royal Ordnance and can also be installed on a number of vehicles. More recently, this turret has been installed for trials purposes on an LAV (8 x 8) chassis and demonstrated in the UK.

### M113 with ADATS

The Swiss Oerlikon-Contraves ADATS (Air Defence Anti-tank System) can be installed on a wide range of tracked and wheeled armoured vehicles. The Canadian Armed Forces selected a modified M113 series APC and a

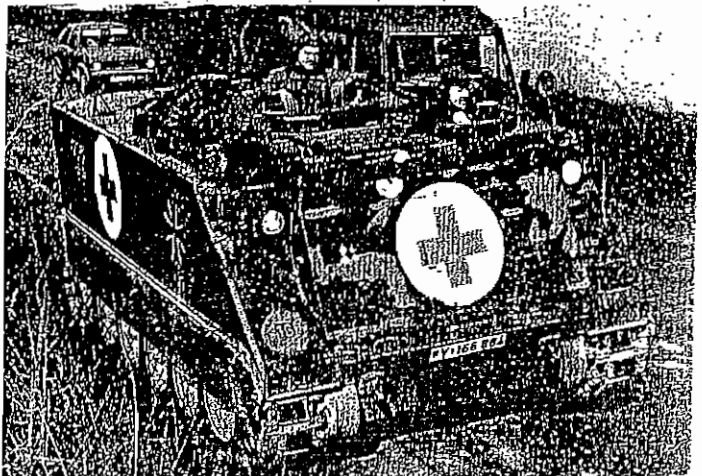

*German M113 series APC being used in the ambulance role (Pierre Touzin)*

## Diesel Division, General Motors of Canada, Armoured Vehicle General Purpose

### Development

In June 1974 the Canadian Armed Forces issued a requirement for an Armoured Vehicle General Purpose (AVGP) for use in Canada. After an initial study of 14 possible vehicles three were selected for field and engineering tests, as a result of which the Swiss MOWAG Piranha (6 x 6) vehicle was chosen.

In February 1977 the Canadian Minister of Defence signed a contract worth \$171 million with Diesel Division, General Motors of Canada Limited, for the supply of 350 vehicles manufactured under licence from MOWAG. The first was handed over in January 1979. The original order for 350 vehicles was subsequently increased to 441 units owing to lower production costs, and early in 1981 was again extended by 35 units bringing the total to 476 units. A further extension of 15 units brought the total order to 491 vehicles. Delivery of this contract was completed by September 1982.

The Canadian vehicles are used by both regular and militia units; have heaters for the engine and crew compartment and are fitted with cold-starting aids. All vehicles have an AN/VVS-501 passive night driving periscope for the driver. The Canadians have three versions of the Piranha:

### Cougar 76 mm Gun Wheeled Fire Support Vehicle (WFSV)

The Cougar, of which 195 were built, is the basic vehicle fitted with the turret mounted on the British CVR (T) Scorpion and the Australian M113A1 Fire Support Vehicle. The turret is armed with a 76 mm L23A1 gun with a 7.62 mm machine gun mounted coaxially with the main armament and four smoke dischargers mounted on either side of the turret. The weapons have an elevation of +35° and depression of -8°, with 360° powered turret traverse. A total of 10 rounds of 76 mm and 220 rounds of 7.62 mm machine gun ammunition is carried in the turret with a further 30 rounds of 76 mm and 15 boxes of 7.62 mm ammunition in reserve in the hull. The Cougar has a crew of three: commander, gunner and driver. It carries an AN-GVS-5 hand-held laser rangefinder.



Wheeled Armoured Personnel Carrier Grizzly with Cadillac Gage 1 m turret armed with 12.7 mm and 7.62 mm machine guns from the rear showing firing ports

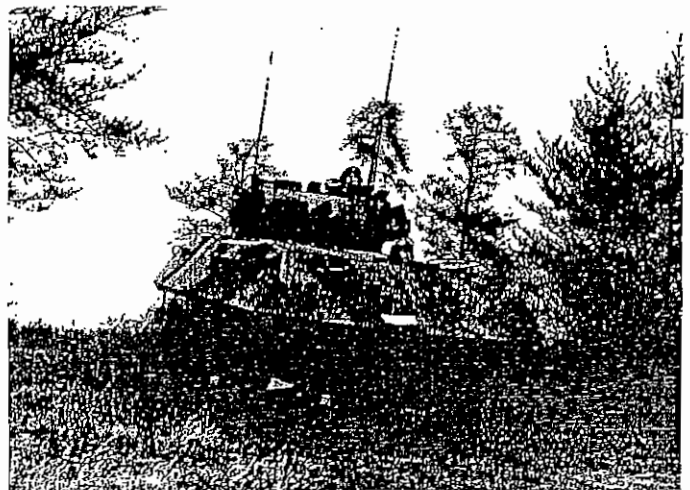

Wheeled Fire Support Vehicle Cougar which has the same turret as British Alvis Scorpion CVR(T) (Canadian Armed Forces)

during mid-1987 four upgraded MARDER ICV experimental vehicles were delivered and subjected to extensive tests. In connection with the advance production engineering six vehicles were modified as pre-production prototypes of the MARDER 1A3 ICV and used from mid-88 onwards for final tests. Basing on a malfunction reporting procedure all user concerns and equipment malfunctions have been noticed in order that necessary changes could be executed quickly and taken into consideration in the serial production.

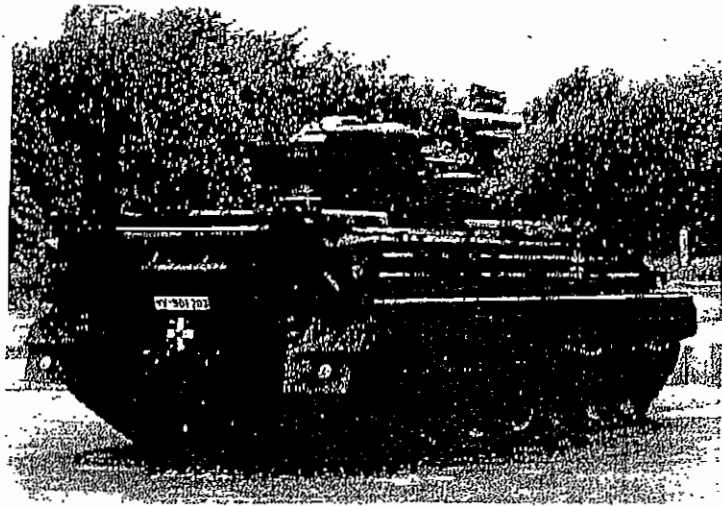

Good to see; add-on armor at turret and on vehicle roof

By means of shock-absorbing fixtures, the add-on armor is added to the basic hull and turret armor in a flush mount-

ing (as contrasting to the "afterthought" look of most add-on armor).

The cooling air for the radiator at the rear of the hull as well as the combustion air for the engine are drawn in from the space between the add-on armor and hull. This design provides permanent air circulation which both reduces the heating up of the vehicle interior by solar radiation and minimizes the infrared signature of the infantry combat vehicle.

Testing of the MARDER 1A3 included, for the first time in Germany, realistic ballistic vulnerability testing of a fully equipped armored vehicle when attacked by gunfire and artillery shell fragments. This test validated total compliance with protection requirements.

### High Ballistic Protection

The use of the latest protection technologies permits an improvement in the ballistic protection levels according to threat by the addition of add-on armor made from spaced-armor steel plates.

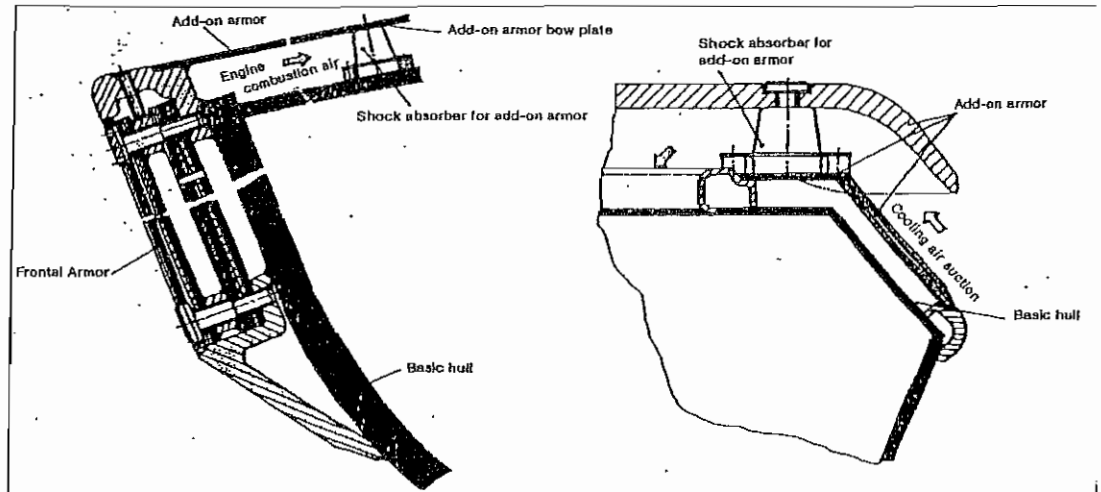

Design details of add-on armor installation

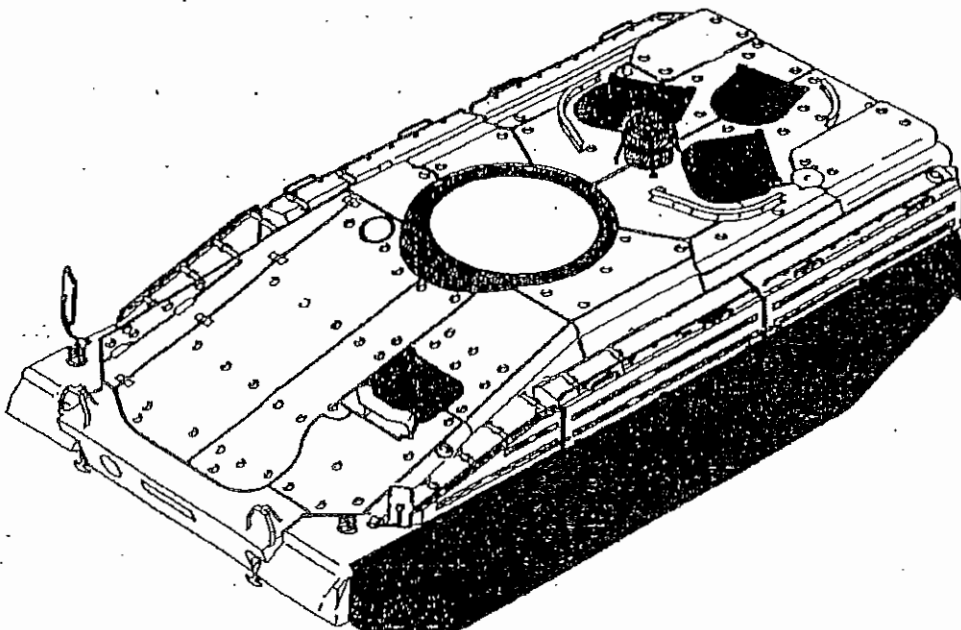

Add-on armor of hull with modified hatches and new storage boxes



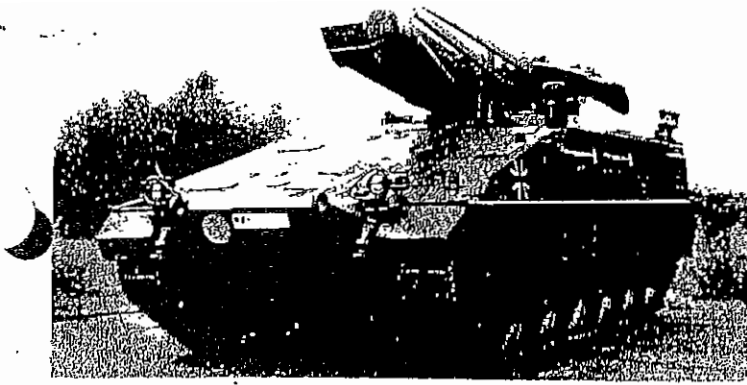

Radarpanzer TÜR with surveillance radar lowered for travelling

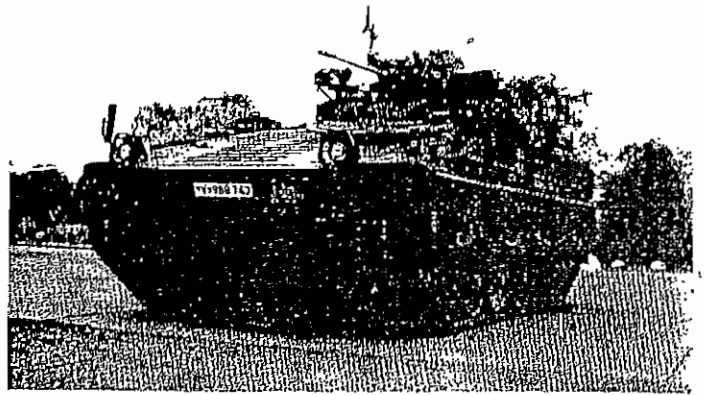

Marder 1 A3 which has many improvements including additional armour protection for the hull and turret, redesigned roof hatches and stowage boxes alongside the hull

of which are given in the Tanks section in *Jane's Armour and Artillery 1985-86*, 57 mm anti-aircraft vehicle (details of which were given in *Jane's Armour and Artillery 1983-84* page 541) and the Dragon twin-30 mm self-propelled anti-aircraft gun system (details of which were given in *Jane's Armour and Artillery 1984-85* page 504).

Note: The Thyssen Henschel VCTP (previously known as the VCI) designation relates only to vehicles being used by the Argentine Army. For other markets, the company calls the vehicle the TH 302 which has slightly

different specifications from the VCPT including a combat weight of 27 tonnes, length of 6.83 m, width of 3.306 m, height of 2.683 m, ground clearance of 450 mm, maximum road speed of 72 km/h and a road range of 460 km. Armament comprises a two-man turret armed with a 20 mm MK 20 Rh 202 Rheinmetall cannon, 7.62 mm machine gun mounted coaxially with the main armament, 7.62 mm anti-aircraft machine gun and a 7.62 mm machine gun in a remote mount over the rear troop compartment. In each side of the rear troop compartment are three upward-opening firing hatches with a periscope above in the roof.

**SPECIFICATIONS** (Key specifications of the upgraded Marder A3 are given in square brackets where applicable)

CREW	9
COMBAT WEIGHT	29 207 [35 000] kg
UNLOADED WEIGHT	28 200 [33 500] kg
POWER-TO-WEIGHT RATIO	20.54 [18] hp/tonne
GROUND PRESSURE	0.83 [0.94] kg/cm <sup>2</sup>
LENGTH	6.79 [6.88] m
WIDTH	3.24 [3.38] m
HEIGHT	
over turret top	2.985 [3.015] m
over hull top	1.9 m
FIRING HEIGHT	
20 mm cannon	2.56 [2.7] m
7.62 mm coaxial MG	2.735 m
GROUND CLEARANCE	0.44 [0.455] m
TRACK	2.62 m
TRACK WIDTH	450 mm
LENGTH OF TRACK ON GROUND	3.9 m
MAX ROAD SPEED (forward and reverse)	
4th gear	75 [65] km/h
3rd gear	47 km/h
2nd gear	31 km/h
1st gear	16 km/h

FUEL CAPACITY	652 l
MAX ROAD RANGE	520 [500] km
FORDING	1.5 m
with preparation	2.5 [2.0] m
MAX GRADIENT	60%
SIDE SLOPE	30%
VERTICAL OBSTACLE	1 m
TRENCH	2.5 m
TURNING RADIUS	
4th gear	30 m
3rd gear	20 m
2nd gear	13.5 m
1st gear	6.5 m
ENGINE	MTU MB 833 Ea-500

TRANSMISSION	4-speed HSWL-194 planetary, 4 forward and 2 reverse gears, integral steering and braking system torsion bar
SUSPENSION	24 V
ELECTRICAL SYSTEM	6 x 12 V
BATTERIES	
ARMAMENT	
main	1 x 20 mm cannon
coaxial	1 x 7.62 mm MG

SMOKE-LAYING EQUIPMENT	6 smoke dischargers
AMMUNITION	
main	1250
7.62 mm	5000
GUN CONTROL EQUIPMENT	
Commander's fire control override	yes
Turret power control	electrohydraulic/manual
by commander	yes
by gunner	yes
Max rate power traverse	60°/s
Max rate power elevation	40°/s
Gun elevation/depression	+65°-17°
Turret traverse	360°
Gun stabiliser	
vertical	no
horizontal	no

**Note:** When originally introduced into service with the German Army the Marder had a crew of 4 + 6 and was fitted with a remote-controlled machine gun over the rear of the troop compartment. Most vehicles also carry one Euromissile ATGW for which six missiles are carried inside the vehicle.

**Status:** Production of the Marder 1 has been completed in both Argentina and Germany. Brazil has four Roland SAM systems based on the Marder chassis in service. Production of the Marder 1 can be resumed if further orders are received.

**Manufacturers:** Production of the Marder was undertaken by Rheinstahl (now Thyssen Henschel) of Kassel and MaK of Kiel.

Thyssen Henschel  
Postfach 102969  
D 3500 Kassel  
Federal Republic of Germany  
Phone: (0561) 8011  
99750

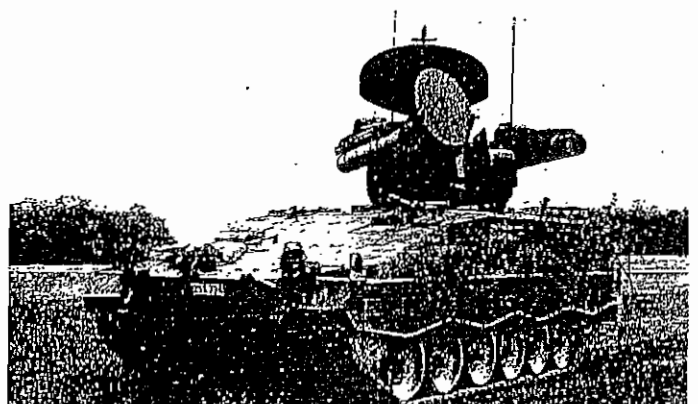

Roland 2 surface-to-air missile system of the German Army (Pierre Touzin)

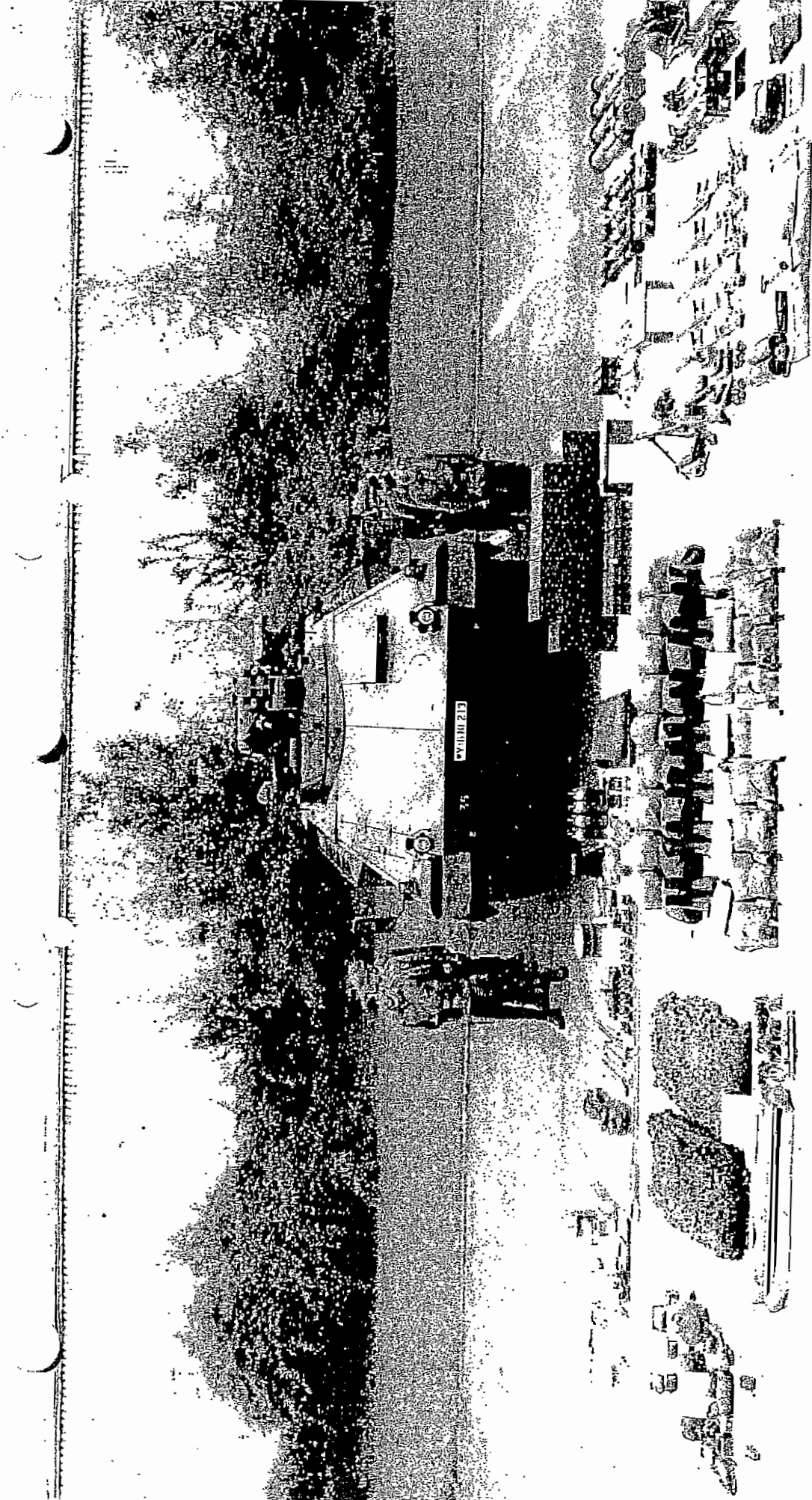



# Karlheinz Schreiber

Sulte 908, 350 Sparks St., Ottawa, Ont. K1R 7S8  
Telephone: (613) 563-3321 Fax: (613) 563-7648

## PERSONAL AND CONFIDENTIAL

March 24, 1993

The Right Honourable  
Brian Mulroney  
Prime Minister of Canada  
Langevin Block  
80 Wellington Street  
Ottawa, Ont.  
K1A 0A2

Dear Prime Minister:

Regarding the order of 229 Light Armoured Vehicles - enhanced for reconnaissance, which Minister Masse sole sourced to GM Diesel Division in April 1992, in place of the MRCV program. I feel I should point out that this is an extremely expensive project (\$800 Million for 229 vehicles), and it will bring negligible improvement to the pressing need for better armour protection on the Canadian Army's armoured vehicles.

On February 10, 1992, the Canadian Ambassador to Germany informed German DND what protection level was required for the RCV (Reconnaissance Combat Vehicle) component of the MRCV project. (Letter attached) It is a matter of fact that there is no technically practical solution to achieve that level of protection against 30mm armour piercing ammunition with the GM LAV -25 vehicle.

I am aware that DND is in direct contact with the German Company Deisenroth in the hope of finding some partial solution for the lack of armour protection on the GM vehicle.

I think it should be of great interest for you to find out why the MRCV project was cancelled and the Army was forced to agree to this sole-source procurement of more of almost the same vehicles which they already had, especially when previously stated requirements for

# Karlheinz Schreiber

PERSONAL AND CONFIDENTIAL

2

protection for the RCV appear to have disappeared.

My suggestion for a more practical solution would be as follows:

1. borrow appropriate equipment from German DOD
2. Reinstate MRCV project to permit earliest possible procurement  
This will be the most advanced vehicle for rapid deployment forces engaged in peacekeeping, incorporating Canadian expertise on peacekeeping, with excellent potential for export and co-production with Canadian allies.

Regarding the pending contract to GM, I recommend the Government avoid that attempt to convert a cow to a horse. Regardless what horse costume DND may put on it the cow will still be a cow.

Most sincerely,

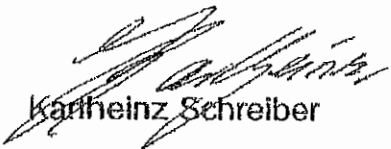

Karlheinz Schreiber





PRIME MINISTER • PREMIER MINISTRE

March 29, 1993

Dear Karlheinz,

*Thank you for your kind words.*

*We were privileged to have had the opportunity of serving Canada. Mila, the children and I now look forward to our return to private life.*

*We thank you for your friendship and support.*

*With best personal regards to your family,*

*Yours sincerely,*

*And wish special thanks  
Brian*

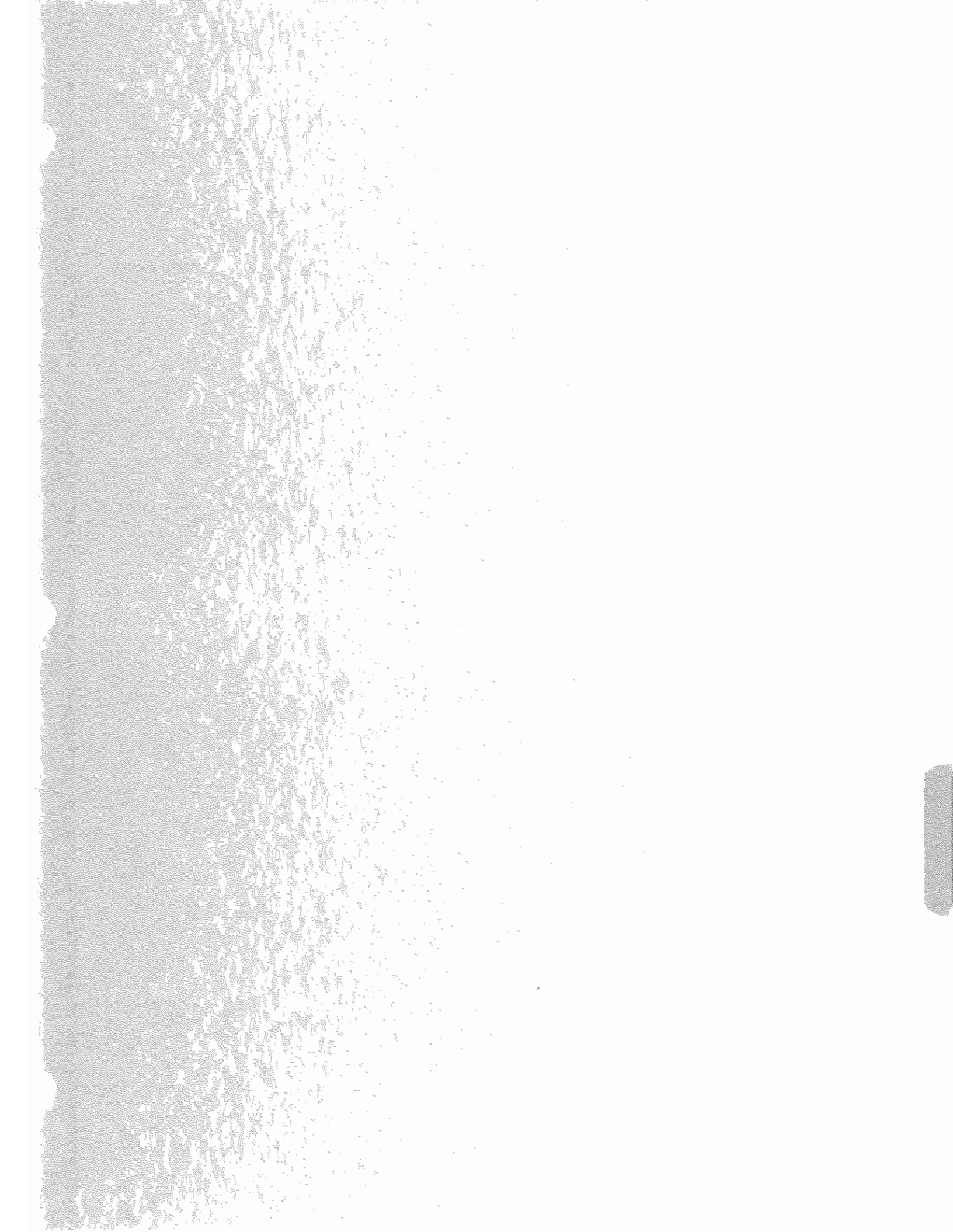



**Brian Mulroney**

Montreal, March 25, 1994.

**BY FAX**

Mr. Karlheinz Schreiber  
Raifferfenstr. 27  
8912 Kaufering  
West Germany 89616

Dear Karlheinz:

Mila joins me in conveying to you our congratulations and warmest regards on your 60th birthday.

Your impressive contributions to both Germany and Canada stand today as a very significant personal achievement.

We look forward to seeing you and Barbél soon.

With very good wishes and best personal regards.

Yours sincerely,



Brian Mulroney

MBM/fc



MILA P. MULRONEY

Dear Babel,

I had  
wanted to put pen  
to paper sooner.  
But at times like  
these words do not  
seem adequate.

I know  
what you are going  
through. It never is  
easy when our husbands  
have difficulties.

Rest assured  
that it will pass.  
Things will get better,  
you have an excellent

---

lawyer and the truth  
is certainly the best  
weapon.

with this note  
I send my best wishes  
to you and your family

most sincerely,

Willa Wiley

January 24, 2000.

---

Barbel

(Personal)



47 FORDEN CRESCENT  
WESTMOUNT, QUEBEC  
CANADA H3Y 2Y5



Karlheinz Schreiber

The Right Honourable  
Brian Mulroney

Montreal

Ottawa, January 14, 2004

Fax 1 514 286 1238

Dear Brian,

From our friend in Nova Scotia I learned that you intended to meet with me.

I think it is a good idea to improve our way of communication.

There are a few important and urgent matters I would like to discuss with you also looking for your advise and support.

Please let me know which dates would be convenient for you for a meeting.

Best regards







Karlheinz Schreiber

102 Bloor St. West  
Suite 511  
Toronto, Ontario  
M5S 1M8

Fax (416) 935 1418  
CEL (416) 578 4022

The Right Honourable  
Brian Mulroney

Montreal

Fax 1 514 286 1238

Toronto, January 25, 2004

Dear Brian,

Until today I received no reply to my fax from January 14, 2004.

I informed you that some important and urgent matters should be discussed. Now the urgency increased dramatically.

Whenever we met and discussed personal and private matters in the past, we were alone and did not involve any lawyers. I strongly recommend to keep it this way.

I hope to hear from you at your earliest convenience.

Best regards

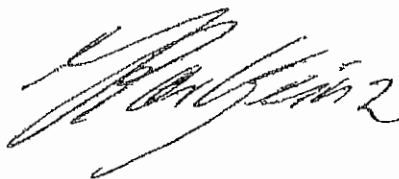

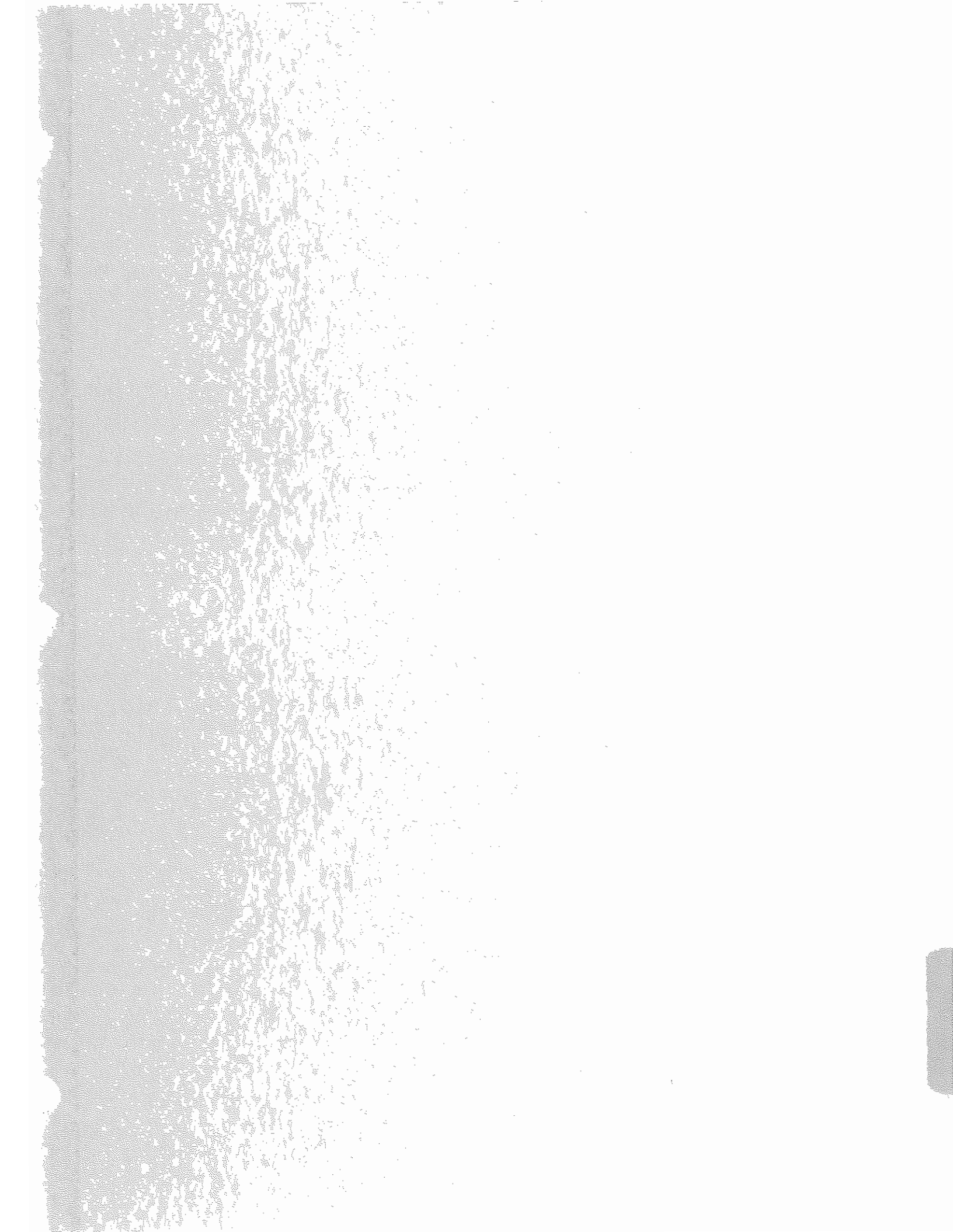

Karlheinz Schreiber

102 Bloor St. West  
Suite 511  
Toronto, Ontario  
M5S 1M8

CEL 001 416 578 4022  
FAX 001 416 935 1418

The Right Honourable  
Brian Mulroney, P.C., LL.D.  
Ogilvy Renault

1981 McGill College Avenue  
Montreal, Quebec  
H3A 3C1

Toronto, July 2004

Dear Brian,

**Report on Business, The Globe and Mail, May 2004**

"Now he's got power"

Is Brian Mulroney Canada's greatest deal broker? Ever? I say: Yes! I saw it already coming when I met you at Harrington Lake.

Since the Reagan funeral, in my opinion, your personal power increased even more and so do your personal obligations to the world.

Fate plays an important role in the life of human beings. We know this. Nobody can escape fate. Fate has put you in my opinion in a position, where you are able to help the human beings, especially the children of North America and around the world, in a dramatic way and your skill may put you in a special historical place and win a Nobel Prize.

There is no greater satisfaction than to save the life and health of children especially the life of the poor.

"Today's children may be the first in American history to live shorter lives than their parents". This statement from Kelly D. Brownell, PHD Director of the Yale Center for Eating and Weight Disorders in his book "Food Fight" and a British study predicting the same for the UK don't disappear from my mind.

**Financial Post Sept. 24, 2003:**

Obesity approaching epidemic levels in the United States according to the Center for Disease Control about 60 % of the adults and 13 % of the children are clinically obese.

The authors of the book Food Fight offer an unflinching assessment of a culture that feeds its pets better than its children, manipulates children into poor eating habits with toy giveaways and in-school promotion and makes it nearly impossible for the poor to be healthy.

**The Globe and Mail May 19, 2004:**

Kid's menus serve up obesity and heart disease.

**The Globe and Mail May 10, 2004:**

Obesity to top smoking as No. 1 killer in US: study a poor diet and physical inactivity caused 400,000 deaths in 2000, a 33 % jump over 1990, said a study released Tuesday by the Centers for Disease Control and Prevention.

Many states are making attempts to slow the increase in obesity among children by limiting their access to unhealthful foods during a school day.

**Los Angeles Times January 23, 2004:**

The State Fat of the Land: Obesity costs State US Billions, Studies Say.

Taxpayers nationwide spent \$ 75 billion in Medicaid and Medicare funds treating obesity related illnesses in 2003, according to a federal report being published today.

The documents attached will show to you in detail, what problems the governments are facing with the growing obesity and related diseases.

It may be fate again that we have the tools to help, but not even knowing it for quite a while.

Fact is we have the tools, so we have to help. Not to try would be unacceptable, irresponsible and incompatible with Christian brotherly love by ignoring the need of the children.

Starving children around the world received help from many Christian organizations, governments and individual human beings.

Now the time has come to provide similar help to our children suffering on our doorsteps. Both groups of children share the same fate – sickness and early death, related to food.

At many places around the world children suffer and die early because of the lack of food. Our children suffer and die early of too much and wrong bad food and beverages.

The governments best choice to help is in my opinion to make sure that healthy, tasty food children love will be served for school lunches at reasonable prices. The success of the right meal at school will rapidly win the interest of human beings all over North America and the world.

The miracle solution to the problem is:

***“ The Healthiest, Tasty Pasta On Earth ”***

The George Brown Chef School and Reto's Restaurant Systems International Inc. started a Pasta Demonstration Project in Toronto.

Children love pasta. It is our goal to provide the best pasta with the most delicious and healthy sauces.

## " THE RETO SYSTEM "

- 1) The Reto brand enriched Pastas are produced with 100 % Durum Wheat Semolina. Ingredients: semolina, niacin, ferrous lactate (iron), thiamin mononitrate (vitamin B1) and riboflavin (vitamin B 2), folic acid.  
No sodium, no cholesterol.  
Low Glycemic Index (GI) value.
- 2) Served with tomato sauce which is rich in lycopene, one of the most effective antioxidants. Many studies have shown that it may reduce the risk of several cancer, heart disease and other health problems.
- 3) The Reto pasta is cooked to order in 70 second without salt or oil, in fresh filtered water with a cooking temperature of 130 centigrade perfectly "AL DENTE".  
("al dente" means: firm to bite). "al dente" pasta has the lowest GI and the best protection of the nutrition value of the pasta..

## THE RETO "al dente" PASTA MEAL

- keeps you fit and slim
- helps you losing weight
- fights obesity, cancer, diabetes, depression, heart disease and birth defects
- provides a healthy energy boost. Athletes like Andre Agassi, Boris Becker, Michael Schumacher, in fact all of those athletes who need a steady release of energy often eat a pasta meal before an event.
- at lunch it keeps you fit and lively
- at dinner it is the best basis for a good sleep
- at all times it fuels your muscles, your brain and central nervous system

The food costs for Reto's pasta with tomato sauce - \$ 1 -

Dear Brian, with your help and the support of Mr. Bill Gates or the Bill and Melinda Gates Foundation we should be able to help fighting the Obesity Epidemic in the USA.

The involvement of Mr. Gates would be to help financing the Pasta-Machines for the schools.

I am convinced that the project will impress you and find your interest to help the children.

Yours very truly



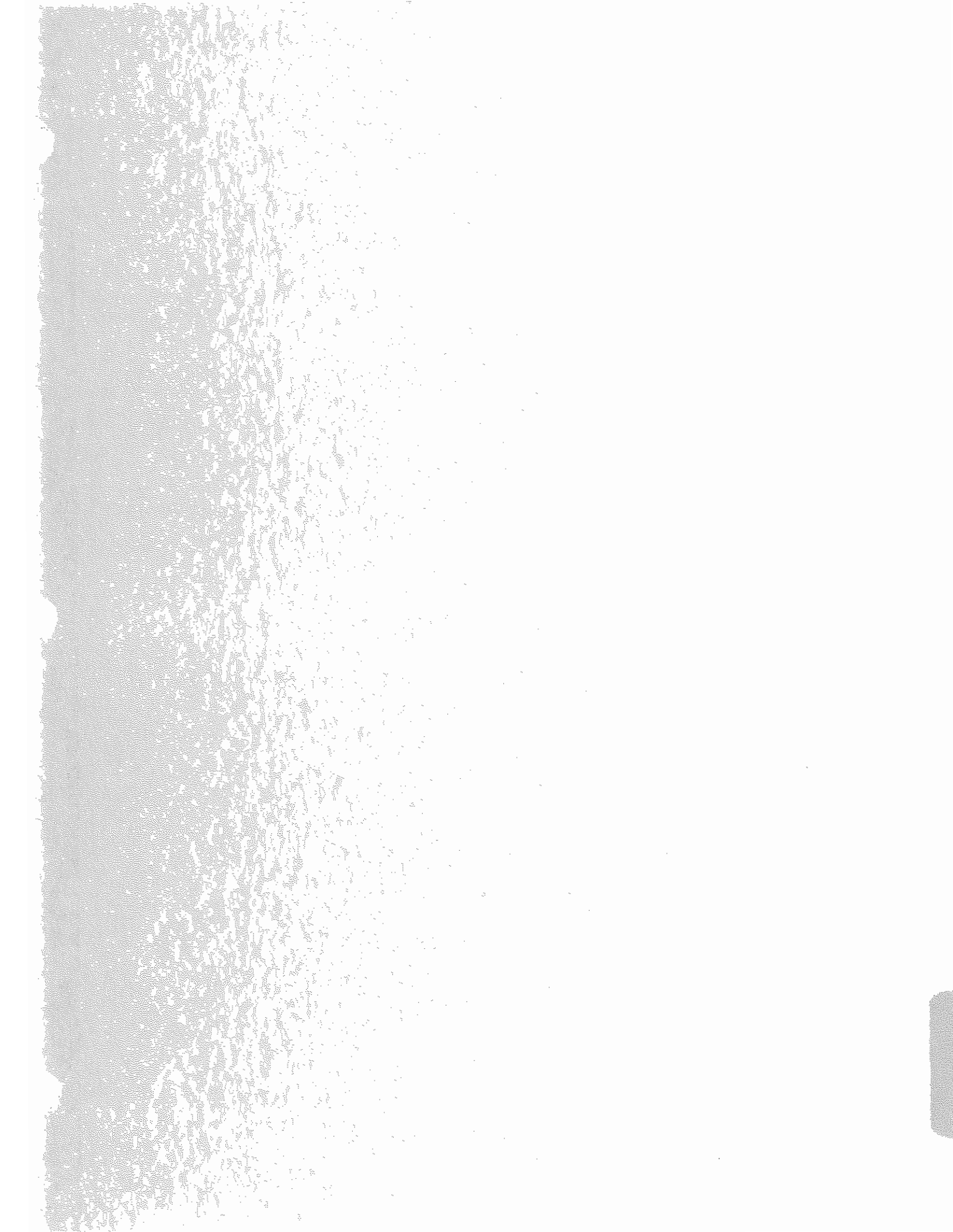

Karlheinz Schreiber

102 Bloor St. West  
Suite 511  
Toronto, Ontario  
M5S 1M8

The Right Honourable  
Brian Mulroney, P.C., LL.D.  
Ogilvy Renault

CEL 001 416 578 4022  
FAX 001 416 935 1418

1981 McGill College Avenue  
Montreal, Quebec  
H3A 3C1

Toronto, July 22, 2004

Dear Brian,

Friends from around the world called and told me, that they never understood better than now, why I like the man Brian Mulroney even more than the Prime Minister Brian Mulroney.

It is the quality of the human being which counts most in life.

Your performance at president Ronald Reagans funeral "I say 'au revoir' today to a gifted leader, historic president and gracious human being" has put you to the top of respect and admiration around the world.

If Franz Josef Strauss, a good friend of Ronald Reagan, would have attended the funeral, he may have added quietly one more outstanding quality to Ronald Reagan: "the most successful actor on earth". By making the leaders of the Soviet Union believe that the US SDI Program would work, ruined the Soviet-Russian economy, finished off communism and brought the cold war to an end.

Your words: "A president who inspired his nation and transformed the world". !

Congratulations!

Yours very truly





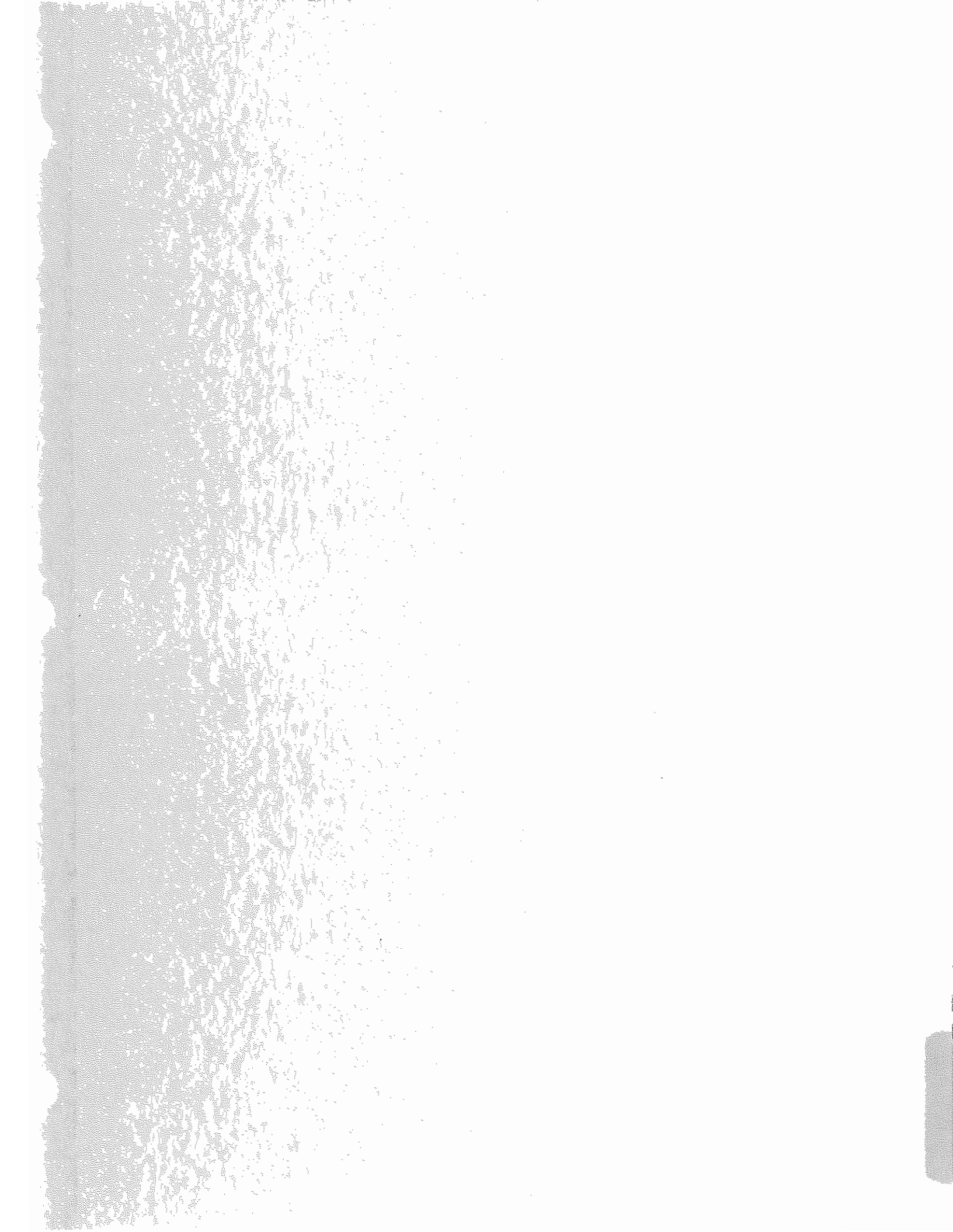

Subj: **Re Proposed Letter**  
Date: 25/06/2006 5:29:07 P.M. Eastern Standard Time  
From: [sharonmackay923@hotmail.com](mailto:sharonmackay923@hotmail.com)  
To: [Schreiberbarbel@aol.com](mailto:Schreiberbarbel@aol.com)

Dear Brian,

I wish to tender my profuse apologies to you for the misleading, erroneous and unfair characterization of your business relationship with me as depicted on the CBC program, "The Fifth Estate."

Without excusing my part, it is fair to say that I was misled by the producers that the program would deal with my complaints about the "sting" operation mounted against me by the RCMP.

May I state for the record, that my testimony under oath in prior legal proceedings is the only correct description of our business arrangement, that is to say, you, after returning to private life, at my request, agreed to advise and consult with me in certain business affairs. You were the best advocate I could have ever retained, and I am grateful for your efforts.

You and I have been the victims for a long time of a vicious, unfounded and totally misleading information. I am convinced that the past Liberal government, Stevie Cameron, Georgio Pelossi and the RCMP are all intertwined in a contemptible conspiracy. You know as well as I that this must be exposed; it will not go away unless strong actions are taken against those responsible.

Again, I apologize for my ambiguity and lack of caution in what I said on t.v. I was confused and upset, not any more!

Yours truly,

Karlheinz Shreiber.

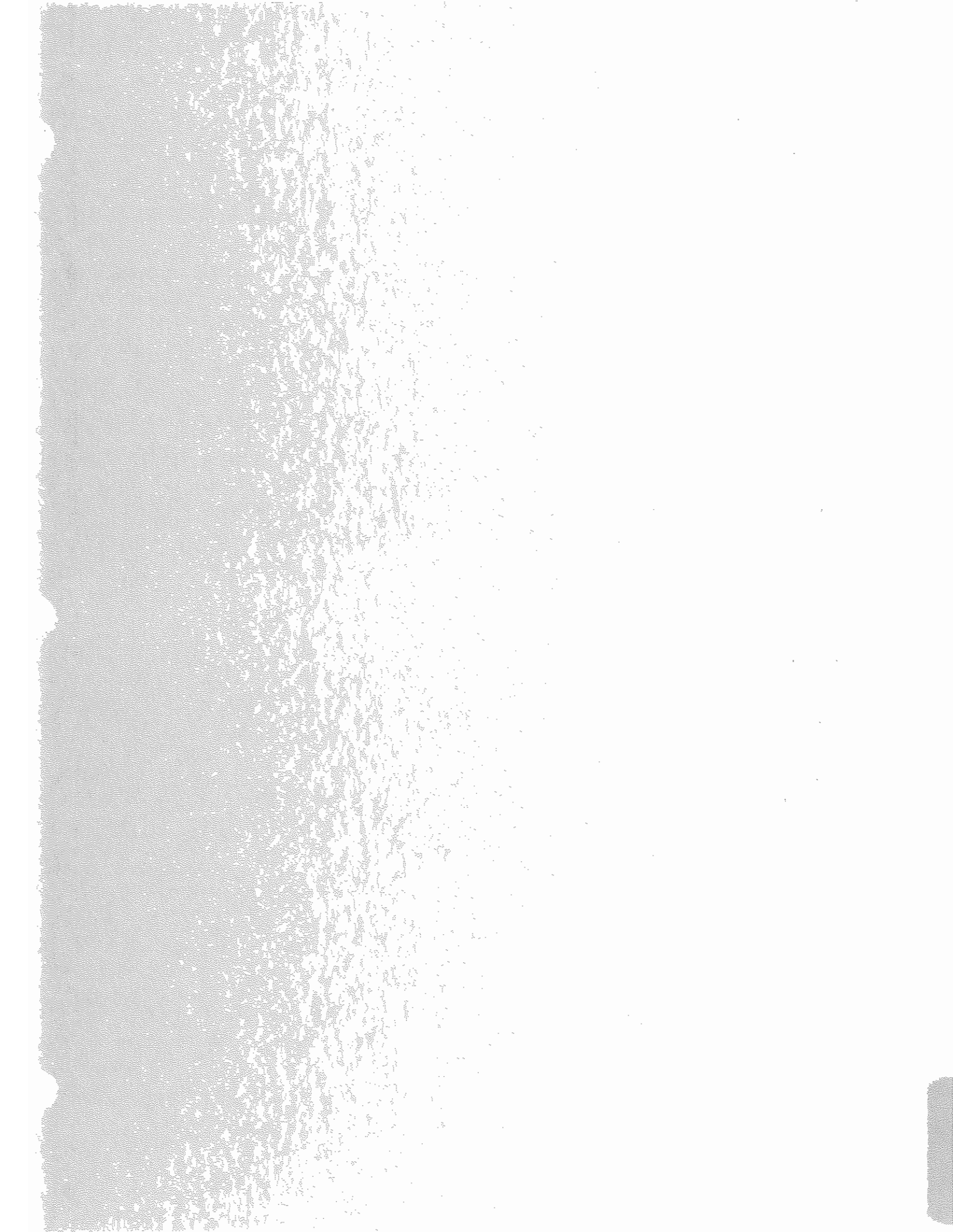

# KARLHEINZ SCHREIBER

The Right Hon. Brian Mulroney, P. C., L L. D.

1981 McGill, College Avenue

Montreal Quebec

H3A 3C1

Ottawa, June 30, 2006

Dear Brian,

Please find as an attachment some documents, which might be of interest to you.

1. Letter to The Right Hon. Stephen Joseph Harper, June 16, 2006
2. Letter to Hon. Allan Rock, January 20, 1997
3. "Political Justice Scandal Canadian Case" – Table of Contents 1 - 24
4. "Political Justice Scandal International Case"- Table of Contents 1 - 22
5. Letter from Department of Justice, Edmonton, June 5, 2006
6. Letter from Robert Hladun Q.C. Edmonton, June 22, 2006

Yours sincerely

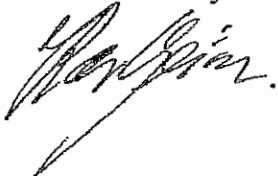

# KARLHEINZ SCHREIBER

The Right Hon. Stephen Joseph Harper P.C., B. A., M. A.  
Prime Minister  
80 Wellington Street  
Ottawa, Ontario  
K1A 0A2

June, 16 2006

**Subject: The Liberal legacy of scandal**

Dear Prime Minister,

The insidious, destructive poison which your government inherited from its predecessors may very well prove to be, in terms of its international repercussions and its impact on Canada's reputation, by far the greatest, most fateful and most damaging scandal in Canadian political history.

The evidence under oath by RCMP Staff Sergeant Fraser Fiegenwald in an Examination for Discovery on March 8, 2006 in a civil action between myself and the Attorney General of Canada and Her Majesty the Queen and at the preliminary hearing in the "Eurocopter" case have finally shed light on the beginning of the fictitious "Airbus Affair" and confirmed the existence of a far more pernicious "Political Justice Scandal".

Staff Sergeant Fiegenwald, the RCMP officer in charge of the investigation, confirmed that the RCMP had no evidence of any criminal behavior involving Prime Minister Mulroney, Frank D. Moores or myself. What he did confirm, in fact, was that the stories came from a convicted Swiss criminal, Giorgio Pelossi, and since 1988 from Stevie Cameron, a journalist, writer and later a confidential RCMP informant and complainant.

As we know, the involvement of the Hon. Allan Rock, then the Minister of Justice, in the "Political Justice Scandal" was not the beginning, but merely one further element in the Liberals consistent strategy of undermining the Mulroney government and thereby seriously damaging the Progressive Conservative Party, with the willing assistance of the Liberal bureaucracy, support from the media, the RCMP and through the Canadian Embassy in Germany the involvement of the district attorney in Augsburg, Germany.

MackAY LAKE ESTATES  
7 BITTERN COURT, ROCKCLIFFE PARK  
OTTAWA, CANADA K1L 8K9  
Tel: 613-748-7330 Fax: 613-748-9697

The players that were responsible for the "Political Justice Scandal" are the individuals who stage-managed it and those who failed to discharge their political responsibilities by remaining silent or tolerating what went on in Canada, Germany, France, Saudi Arabia, Thailand, Costa Rica, Austria, Liechtenstein and Switzerland damaging conservative politicians including suicides and changing the political situation in Europe.

The initiators: Hon. Allan Rock, Stevie Cameron, CBC The fifth estate, Giorgio Pelossi.

Responsible yet silent: The Right. Hon. Jean Chretien, The Right. Hon. Paul Martin, Hon. Anne McLellan, Hon. Martin Cauchon, Hon. Irwin Cottler.

Dereliction of duty:

Solicitors General: Hon. Herb Gray, Hon. Andy Scott, Hon. Lawrence MacAulay, Hon. Wayne Easter, Hon. Anne McLellan.

The abused: The RCMP with Commissioners J.P.R. Murray and Giuliano Zaccardelli, who rejected the initial allegations by Hon. Allan Rock Minister of Justice as unsubstantiated, but apparently yielded subsequently to political pressure or opportunism.

This strategy, which we can say, based on what I now know, is ongoing and the persecution and the cover-up of the "Political Justice Scandal" continue, both here in Canada and in the international arena. The Hon. Elmer MacKay was correct in his letter August 27, 1997 to Commissioner J. P. R. Murray when he named the matter to be a long term "ass-covering and face-saving" operation simultaneously.

On Jan 9, 1997 Allan Rock, Minister of Justice & Attorney General of Canada and Philip Murray, Commissioner of RCMP sent a letter of apology to me and informed me about the settlement agreement with the Right Hon. Brian Mulroney. My answer in a letter Jan 20, 1997 was: "I recognize your apology but this matter will only be properly clarified in a courtroom".

On October 24, 1997 my lawyer filed the Statement of Claim in the Court of Queen's Bench of Alberta in Edmonton.

On March 1, 2001 RCMP Supt. Mathews learned from Jim Shaw, an Edmonton counsel representing the Federal Government of Canada, about the problems with a confidential RCMP Informant. Supt. Mathews tried to fix the problem and coded Stevie Cameron seven years backwards "code 2948" in order to protect the Crown and not to jeopardize the Alberta case with Karlheinz Schreiber.

My lawyer Edward L Greenspan Q. C. stated in an interview with the Globe & Mail 26/02/04: "We are at the front end of what will prove to be an incredible scandal." Mr. Greenspan said it will eventually emerge that top figures in the Liberal government approved the investigation of Mr. Mulroney, knowing full well it was being launched on information from an anonymous journalist.

There are still unresolved matters in the Eurocopter case, as Ontario Superior Court judge Edward Then has yet to rule on whether he was misled by the RCMP or the Crown when he issued orders in 2001 sealing court documents.

The RCMP abandoned the Airbus investigation in 2003, but the baton was passed to the fraud case involving Eurocopter Canada (MBB Helicopters). Once again, the ultimate target of this case was Brian Mulroney. I then found myself, after a two-year RCMP sting operation, once more in the position of the victim of an unsuccessful attempt to designate me as a hostile witness.

In November 2005, Justice Bélanger dismissed the Eurocopter case for lack of evidence and thereby finally laid the "Airbus Affair" to rest.

On December 30, 2005 the Crown appealed this judgment, thereby resurrecting the "Airbus Affair" and with it, implicitly, the allegations against Brian Mulroney.

The situation leaves my claim for damages against the Attorney General as the only avenue that can lead to disclosure in a courtroom of the truly unbelievable extent of the vendetta waged by the former government against Brian Mulroney, Frank D. Moores, myself and ultimately the Conservative Party and a number of highly respected international companies, including Thyssen ( now ThyssenKrupp ), MBB ( now Eurocopter ) and Airbus Industries with EADS and DaimlerChrysler.

In order to avoid my demolishing this vendetta once and for all in a Canadian courtroom, through my lawsuit, the justice system has until now sought to have me extradited to Germany, based on an Extradition Treaty without Reciprocity, downgrading the value of my Canadian Citizenship or to neutralize me by having me put in jail in Canada with the help of undercover agents and misleading statements to the court regarding my bail conditions.

Since 1996, many Members of the House of Commons, including your self, Mr. Gilles Duceppe, Mr. Peter MacKay, Mrs. Pierrette Venne, Mr. Jack Ramsay, Mr. Michel Bellehumeur, Mr. Chuck Strahl, Mr. Kevin Sorenson, and members of the Senate have asked from time to time in vain for an official investigation. I submit time has finally come for Canadian taxpayers to be able to find out what the "Political Justice Scandal" has cost so far and what will be the estimated costs for the ongoing saga and the upcoming lawsuits for damages.

Brian Mulroney, the international Industrial Companies, many conservative politicians and I have borne the brunt of the case for the past twelve years and at this point there is still no closure in sight.

The result of the recent federal election changed the situation and all pending actions of the "Political Justice Scandal" in Canada and other countries are now under the jurisdiction of your government.

Will the Attorney General in your government continue with the delay tactics of the Liberal Attorneys General in my Alberta court action who hope that I lose my extradition case at the Supreme Court of Canada and be extradited to Germany?

This would prevent me from pushing forward the legal case and bury the "Airbus Affair" and the "Political Justice Scandal" at the same time. Would this be in the interest of Canada? I think not.

Will the Minister of Justice & Attorney General like his predecessor ignore the false German statements and political blackmail in my extradition case?

My lawyer Mr. Edward L. Greenspan Q. C. informed the Hon. Vic Toews Minister of Justice & Attorney General about the comments recently made publicly by the Chief Prosecutor and by the Judicial Spokesperson for the Court in Augsburg, Germany.

No cleanup in government can take place in Canada without an intensive parliamentary investigation of what is, in terms of its international implications, the largest scandal in Canadian history. This is entirely consistent with your announced intention to appoint an independent Director of Public Prosecutions, the Federal Accountability Act and Action Plan.

In 1985, I became the Chairman of Thyssen-Bearhead Industries and came to Ottawa on the request of the Canadian Government and the Right Hon. Prime Minister Brian Mulroney to create jobs in the Province of Nova Scotia. For eight years I worked on the project. I had to learn that the Liberal bureaucracy with Paul Tellier and Bob Fowler in Ottawa undermined the policies of the strong majority Government of Brian Mulroney at every opportunity. What I did find? Lies, fraud, attempt of manslaughter, conspiracy, greed, ignorance, arrogance, disappointment, breach of agreements and great sadness for Canada and Canadians. Thyssen, the Canadian soldiers, the people of Nova Scotia and I have been misused and betrayed after Thyssen spent more than \$ 60 million on the project for peacekeeping and environment-protection.

I am sure you will appreciate that under the circumstances I can only turn to you, since all the other government agencies responsible are still involved and as a result are not interested in clarification. I have taken the liberty of attaching a number of documents for your information.

Prime Minister this is your opportunity to bring this insanity to an end and the truth coming out in the greatest political cleanup in Canadian History.

The "Political Justice Scandal" began in the year 1994, is still moving ahead and will not disappear on its own.

Yours sincerely,

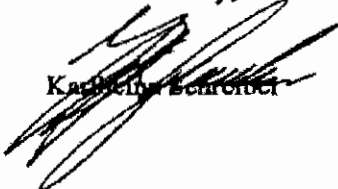

Karlheinz Schüröckel



**Karlheinz Schreiber**

86916 Kaufering Raiffeisenstrasse 27 Telefon (08191) 7884 Telefax (08191) 7888

January 20, 1997

Honourable Allan Rock  
Minister of Justice &  
Attorney General of Canada

- and to -

Phillip Murray  
Commissioner, RCMP

Dear Sirs:

This letter is written as an open letter to yourselves and to the Canadian public as a response to your letter of apology sent in care of my lawyer, Mr. Robert W. Hladun, Q.C. on January 9, 1997. A number of things were mentioned in that letter besides the apology and accordingly, it has become necessary for me to respond to that letter. I will address each point as it appears in your letter of January 9, 1997, a copy of which is attached for your convenience. Addressing each point in order as follows:

1. I wish to express my satisfaction with the settlement you have reached with the Right Honourable Brian Mulroney. I can only state that this is a settlement that should have been reached much earlier and an apology which should have been given from the outset.
2. It is no news to me that the Government of Canada sought assistance from Switzerland. I was told that I was not being accused of any crime. However, I was implicated in the circumstances described in the Letter of Request from the moment the Canadian Government demanded access to accounts of mine all over Switzerland, also all of those accounts over which I may have had a proxy. On the direction of the Canadian government, the Swiss authorities caused a search and seizure of all of my banking papers and documents, whatsoever.

3. Whether or not it is reasonable for the Canadian Government to believe that the request for assistance was a highly confidential state-to-state communication remains to be seen. It is utter nonsense to state that the Swiss would understand that this Request for Assistance contained only allegations that were to be verified given the wording of the Request for Assistance. The Request for Assistance reads like a summary of facts and includes such statements as "this investigation is of serious concern to the Government of Canada as it involves criminal activity on the part of the former Prime Minister." In fact, if you look at the entire Letter of Request and the statements that are set out therein as facts, one must question how the Swiss are to understand these as being merely allegations, and "that the persons named were presumed innocent of any wrongdoing." In fact, nowhere in the Request for Assistance is it explicitly stated that the people named therein are presumed innocent and that these are only allegations. Indeed, the Letter of Request reads like a criminal indictment.
4. I can easily imagine that requests for assistance have been sent to Switzerland before which have remained confidential. However, I have the feeling that you did not grasp the difference between a request for assistance or information and a request for search and seizure which is what happened in my case. The average Canadian would have difficulty understanding that search and seizure is to remain confidential when the Letter and its contents are given by the police force in Switzerland to all sorts of bank employees from the board of directors down to the tellers at the counter.
5. The Canadian Government asked the Swiss to search and seize every account all over Switzerland which I owned or over which I had a proxy. The Swiss refused to do so and instead asked for copies of my banking documents. This has had a great impact on my reputation when you consider I have maintained a house in Switzerland and conducted banking there over the past twenty years.

If you ask to search offices, homes or apartments in Switzerland, invariably investigators will show up in four or five cars, they will look everywhere and will put everything of interest in boxes and transport them to their offices. Do you still expect something like this to remain confidential? This is akin to expecting that a request for the arrest and extradition of an individual in a foreign country will remain confidential.

6. Given the revelations regarding Sergeant Fiegenwald in media reports, this last paragraph is somewhat ridiculous. The tone and content of this paragraph only tells me and the Canadian public that the Government of Canada is totally unprofessional in formulating requests for assistance. A search and seizure or arrest can in and of itself never stay confidential. On the other hand, requested countries respect their law which requires them to disclose requests for search and seizure to the suspects. Since there is a dramatic difference between confidentially asking for information and a search and seizure, all civilized

countries are required to provide a search warrant from a proper court. I can provide you copies of Mutual Legal Assistance Treaties of all members of the European Community which show that search warrants are required.

It is readily apparent to me that the officials of the Canadian Government did not honour the *Treaty for Mutual Legal Assistance* entered into between Canada and Switzerland which was signed on October 7, 1993. It requires the Canadian Court to issue a declaration that such a measure would be permissible if the subject matter of the search and seizure were located in Canada prior to it being executed upon by the foreign country. As Justice Wetston ruled on July 4, 1996, the Canadian Government would not have been able to carry out a similar search and seizure on Canadian soil. Further, it is of interest that the *Treaty* was ratified in Canada on November 17, 1995 and the Letter of Request was sent in "just under the wire" on September 29, 1995. The only person competent to issue a search warrant is a judge or someone acting judicially. However, if it is your position that a competent authority is a police force acting on its own, then that reminds me of the nightmare years of my childhood when the Nazi regime set loose the Gestapo on the German public.

7. I also take great pleasure in learning today that it is recognized that I am "presumed innocent" as required by law under the *Charter* but for over the past year you have permitted the Letter of Request to stand where it names me as a criminal and sets out in great detail the criminal indictment as to the crime that I was implicated in. The person with whom I am to have perpetrated the crime is the former Prime Minister, Brian Mulroney. It is interesting that as of January 6, 1997, the Government of Canada says that there is no evidence to say that he was involved in criminal activity and you apologize to me for having reached a conclusion that I was involved in the criminal activity but you insist that there is still an ongoing criminal investigation. This begs the question - What criminal activity?

The Request for Assistance states that I was involved in the crime of bribing the former Prime Minister. You now say that - "No, you are not involved in that. For saying that you were, we apologize. However, we will still investigate." It is unclear to me, and I am sure the Canadian public feels the same, what it is that you are investigating. The whole foundation upon which the Request for Assistance is built has collapsed with the apology to the former Prime Minister.

I would not wish the enormous pain, suffering and embarrassment that you have caused for my friends and family on anyone. You have acted deliberately and recklessly in sending out the Letter of Request without foundation, and today, sixteen months later, you feel the need to apologize.

8. With respect to this paragraph, I would merely point out that this was not only the RCMP that had a hand in this letter but your own Department of Justice as well

and accordingly can be accused of reaching the same conclusions that the RCMP did.

9. I recognize your apology but this matter will only be properly clarified in a court room. This is my understanding. I have been a judge for commercial matters for nine years in Munich. Perhaps, I have a different understanding of law and order than you do.

Since the letter you sent me appeared in the media, this letter is provided to the media in order to give the Canadian public my side of the story.

Yours truly,



KARL HEINZ SCHREIBER

# "Political Justice Scandal"

## Canadian Case

DRAMATIC NEW MATERIAL ADDED

**ON**

**THE**

**TAKE**

CRIME, CORRUPTION  
AND GREED IN  
THE MULRONEY YEARS

STEVE GARDNER

A black and white portrait of a man with dark hair, wearing a dark tuxedo jacket, a white dress shirt, and a dark bow tie. He is smiling slightly and looking towards the camera. The portrait is positioned on the right side of the book cover, partially overlapping the text blocks.

**POLITICAL JUSTICE SCANDAL  
CANADIAN CASE**

**TABLE OF CONTENTS**

---

<b>"ON THE TAKE" / POLITICAL JUSTICE SCANDAL / RCMP/FBI</b>	<b>1</b>
<b>CANADIAN LETTER OF REQUEST TO SWITZERLAND</b>	<b>2</b>
<b>LETTER OF APOLOGY TO KARLHEINZ SCHREIBER / BEGINNING OF LEGAL PROCEEDINGS 1997</b>	<b>3</b>
<b>FRASER FIEGENWALD / RCMP</b>	<b>4</b>
<b>SWISS-LAWYER DR. ROLAND BRUHIN / KIM ROWE, OTTAWA</b>	<b>5</b>
<b>RCMP UNDERCOVER STING OPERATION / KARLHEINZ SCHREIBER/ EUROCOPTER CANADA LTD/VAHE MINASIAN/MICHEL COGGER/ BRUNO SCHIRRA, MAGAZIN DIE ZEIT</b>	<b>6</b>
<b>"THE LAST AMIGO" STEVIE CAMERON / KARLHEINZ SCHREIBER SOME PAGES TO READ ABOUT THE LIBERAL BUREAUCRATS AND THE UNDERMINING OF THE ELECTED POLITICIANS / INDEX</b>	<b>7</b>
<b>LETTER FROM RCMP COMMISSIONER G. ZACCARDELLI</b>	<b>8</b>
<b>EUROCOPTER: ONTARIO SUPERIOR COURT OF JUSTICE / THEN J.</b>	<b>9</b>
<b>CALL RCMP AND CAMERON TO TESTIFY, LAWYER URGES EDWARD L. GREENSPAN Q.C.</b>	<b>10</b>
<b>EUROCOPTER / HOSTILITY DECISION JUSTICE PAUL BELANGER</b>	<b>11</b>

<b>LETTER TO RCMP COMMISSIONER FROM THE HON. ELMER MACKAY</b>	<b>12</b>
<b>JOURNALIST CAMERON FILES COMPLAINT AGAINST RCMP</b>	<b>13</b>
<b>EUROCOPTER CASE DISMISSED</b>	<b>14</b>
<b>CROWN APPEAL RESURRECTS AIRBUS AFFAIR / 39<sup>TH</sup> PARLIAMENT, JUNE 13, 2006 / AIRBUS, MR. DAVID MCGUINITY</b>	<b>15</b>
<b>AIRBUS INDUSTRIE / EUROCOPTER / EADS / DAIMLERCHRYSLER</b>	<b>16</b>
<b>THYSSENKRUPP</b>	<b>17</b>
<b>THYSSEN BEAR HEAD INDUSTRIES LTD</b>	<b>18</b>
<b>DEBATES OF THE SENATE</b>	<b>19</b>
<b>ORAL QUESTION PERIOD / AIRBUS</b>	<b>20</b>
<b>SENATE DEBATES / AIRBUS</b>	<b>21</b>
<b>MEDIAS ROLE IN THE AIRBUS SCANDAL INVOLVING BRIAN MULRONEY (VERY INTERESTING TO READ)</b>	<b>22</b>
<b>TOP TEN SCANDALS IN CANADIAN POLITICAL HISTORY</b>	<b>23</b>
<b>TOP 11 POLITICAL LEAKS AND SCANDALS</b>	<b>24</b>

# **“Political Justice Scandal” International Case**

(The last Amigo)

**“I have to caution you, this is not a game . . .”  
– Karlheinz Schreiber**

---

**A political thriller, a business exposé,  
and the unmasking of an international  
web of power, money, and influence**



ISBN 1-55199-051-?





**POLITICAL JUSTICE SCANDAL  
INTERNATIONAL CASE**

**TABLE OF CONTENTS**

---

<b>"THE LAST AMIGO" INDEX</b>	<b>1</b>
<b>"ON THE TAKE" THE CANADIAN EMBASSY / PUBLIC PROSECUTOR AUGSBURG, GERMANY</b>	<b>2</b>
<b>GIORGIO PELOSSI AND THE RCMP, SEPTEMBER 1995</b>	<b>3</b>
<b>STEVIE CAMERON AND THE PUBLIC PROSECUTOR IN AUGSBURG</b>	<b>4</b>
<b>RCMP LIAISON OFFICER BRETTSCHEIDER AND THE PUBLIC PROSECUTOR IN AUGSBURG</b>	<b>5</b>
<b>THE CDU FINANCIAL SCANDAL / AN AICGS REPORT</b>	<b>6</b>
<b>GERMAN CHANCELLOR HELMUT KOHL / WOLFGANG SCHAEUBLE</b>	<b>7</b>
<b>GERMAN CHANCELLOR GERHARD SCHROEDER</b>	<b>8</b>
<b>GERMAN SUICIDES TIED TO SCANDAL</b>	<b>9</b>
<b>"FRENCH CONNECTION" IN GERMAN SCANDAL</b>	<b>10</b>
<b>THE KINGDOM OF SAUDI-ARABIA AND THE GERMAN SCANDAL</b>	<b>11</b>
<b>THE DEPUTY PRIME MINISTER OF THAILAND AND THE GERMAN SCANDAL</b>	<b>12</b>
<b>THE GOVERNMENT OF COSTA RICA AND THE GERMAN SCANDAL</b>	<b>13</b>
<b>GERMAN CHANCELLOR ANGELA MERKEL</b>	<b>14</b>

<b>PREMIER OF BAVARIA EDMUND STOIBER</b>	<b>15</b>
<b>FRANZ JOSEF STRAUSS</b>	<b>16</b>
<b>SCHREIBER TARGETED</b>	<b>17</b>
<b>JUDGE KARL-HEINZ HAEUSLER / REGIONAL COURT OF AUGSBURG</b>	<b>18</b>
<b>HELMUT KOHL, HANS-DIETRICH GENSCHER, KLAUS KINKEL, THEODOR WAIGEL / TESTIMONY IN PFAHLS PRIBE CASE</b>	<b>19</b>
<b>LETTER FROM LAWYER JAN OLAF LEISNER TO THE PUBLIC PROSECUTOR IN AUGSBURG, REPORT GERMAN TELEVISION PFAHLS: JUDGEMENT AT ANY PRICE – THE AUGSBURG LEGAL SCANDAL. JUDGE HOFMEISTER’S “THANK YOU HANDSHAKE” TO DR. PFAHLS</b>	<b>20</b>
<b>DEPARTMENT OF JUSTICE SWITZERLAND / LETTER TO MINISTRY OF JUSTICE DUESSELDORF, GERMANY DISAPPROVAL OF LETTERS ROGATORY (VERY IMPORTANT TO READ)</b>	<b>21</b>
<b>A GERMAN-CANADIAN FIGHTS EXTRADITION</b>	<b>22</b>

Canada

Edmonton Office  
Prairie Region  
211 Bank of Montreal Bldg  
10199 - 101 Street  
Edmonton, Alberta  
T5J 3Y4

Canada

Bureau d'Edmonton  
Région des Prairies  
Édifice de la Banque de Montréal  
211 rue 101 - 10199  
Edmonton, Alberta  
T5J 3Y4

Telephone: (780) 495-6051  
Facsimile: (780) 495-6300

Internet: cashcrof@justice.gc.ca

Our File: 2-77605  
Notre dossier:

Your File:  
Votre dossier:

June 5, 2006

BY FAX

Hladun & Company  
Barristers and Solicitors  
100, 10187 - 104 Street  
EDMONTON, Alberta  
T5J 0Z9

Attention: Robert W. Hladun  
Fax # 424-0934

Dear Sir:

RE: Schreiber v. The Attorney General of Canada

I am assisting Jim Shaw with this file.

I understand that you have asked us to produce our documents.

We have reviewed Mr. Schreiber's Amended Amended Statement of Claim, and the Affidavit of Records. If this action is to proceed, our view is that Mr. Schreiber will need to file a further and better Affidavit of Records.

Below, we speak of the Statement of Claim, but in each case are referring to the Amended Amended Statement of Claim.

Referring to para. 12 of the Statement of Claim, we understand that Mr. Schreiber received some sort of notification of the Swiss authorities' request for banking records from the Swiss Union Bank. Mr. Schreiber should disclose the documents related to the notification in his Affidavit.

As you know, Mr. Schreiber is responsible to produce documents which are or were in his custody and control, which includes documents of companies which he owns or controls, or has owned or controlled. We understand that Mr. Schreiber conducted his business through several companies. Mr. Schreiber will need to produce any relevant and material documentation from these companies. Such documents would include, but not be limited to, records of contracts or understandings in principle between Mr. Schreiber's companies and such companies as MBB, Thyssen Industrie AG, Airbus Industrie, and Bear Head Manufacturing Industries BMI Inc.

This is Exhibit "A" referred to in the  
Affidavit of  
Joanne Romans  
Sworn before me this 13<sup>th</sup> day  
of July, A.D., 2006  
Tania Norris  
A Notary Public, A Commissioner for Oaths  
in and for the Province of Alberta  
TANIA NORRIS  
Commissioner of Oaths  
My Commission Expires  
May 30, 2009

Canada

Documents held by Mr. Schreiber's lawyers or ex-lawyers remain within Mr. Schreiber's possession or control, and therefore Mr. Schreiber should produce non-privileged documents relevant to this matter which are in the possession of Mr. Schreiber's lawyers or ex-lawyers, including Peter Widmer.

Referring to para. 12 of the Statement of Claim, Mr. Schreiber should have banking records which relate to this matter. Such documents would include banking records from Verwaltungs-Und Private Bank in Vaduz, Liechtenstein. Banking records of companies controlled by Mr. Schreiber which relate to the allegations in the Statements of Claim and Defence are also relevant to this matter.

The documents would also include bank documents showing payments from MBB, Thyssen, Airbus Industrie, and Bear Head Manufacturing to IAL or other companies controlled by Mr. Schreiber, and payments from companies controlled by Mr. Schreiber to persons such as Mr. Moores and Mr. Schreiber, or companies such as Consultants International Incorporated.

You have said in discoveries that the ownership of IAL was by bearer certificate. Mr. Schreiber should be able to produce the bearer certificate or advise when it left his possession. There should be other relevant IAL documents. Even if some of them are no longer in Mr. Schreiber's possession or control, they should be listed in the Affidavit.

Referring to para. 14 and 15 of the Statement of Claim, Mr. Schreiber should have a copy of the letter of apology, and his own letter to the Deputy Attorney General and the Commissioner of the RCMP, and any letter he received in response. If he has other correspondence related to his alleged efforts to obtain apologies or revisions to Crown documents, that documentation should be produced.

Referring to para. 20 of the Statement of Claim, we understand that Mr. Schreiber says that he did pay some money to Brian Mulroney. He should produce documentation related to those payments.

Referring to para. 20 of the Statement of Claim Mr. Schreiber states there was no criminal activity as set out in the Letter of Request, or at all. He has denied criminal activity. He has put all of his business dealings into issue. He has also made many public statements, or responded in books and interviews. Mr. Schreiber must inform himself of all of that and disclose all documents relating to the matter which are relevant and material to this lawsuit.

At para. 30 of the Statement of Claim, the Plaintiff alleges that he has lost economic opportunity and income. He must have documentation in relation to that claim, and he will need to produce it.

At para. 19 of the Amended Statement of Defence, we allege that Mr. Schreiber provided Mr. Mulroney with a copy of the German version of the Letter of Request. If Mr. Schreiber has or had a copy of the German version, it should be set out in his Affidavit.

- 3 -

In *Germany v Schreiber*, before Mr. Justice Watt, there is reference to Mr. Schreiber's personal organizer. Documentation from the organizer which is material to this lawsuit must be produced.

Further, your client has been involved in many lawsuits related to this matter. All documentation which he or his counsel has received in these lawsuits is now within his possession or control, and must be produced in this matter. For example, Mr. Schreiber sued CBC, and should have documents produced during that lawsuit for disclosure, as well as documentation of his own related to that lawsuit which is also relevant and material to this lawsuit.

Some time has elapsed since 2003. Your client will likely have new relevant and material documentation in his possession, which should be added to his production.

Of course, we are unable to know exactly what relevant and material documents your client has in his possession or control. Clearly, however, his present Affidavit of Records is deficient.

We know you will review Mr. Schreiber's responsibilities respecting document production with him, to ensure compliance with his legal obligation to locate, gather, and produce all documents material and relevant to this matter. No doubt there are more material and relevant documents beyond what we have requested in this letter.

We look forward to receiving your filed further and better Affidavit of Records.

Yours truly,

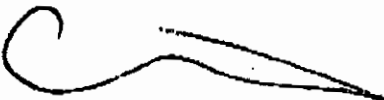

Christine Ashcroft  
Counsel

jr



Tel. 780.423.1888 100 St. James Street West, Suite 1000, Toronto, Ontario M5H 2B4  
Fax. 780.424.0974 3000 West Broadway, Suite 1000, Vancouver, British Columbia V6Z 1Y1  
www.hladun.com 604.681.1000

15737

2-77605

June 22, 2006

This is Exhibit "B" referred to in the Affidavit of

Joanne Romans

Sworn before me this 13th day of July A.D., 2006

of Tania Norris  
A Notary Public, A Commissioner for Oaths  
in and for the Province of Alberta

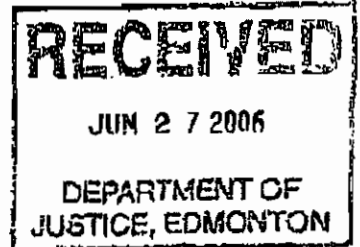

Ms. Christine Ashcroft  
Department of Justice Canada  
#211, 10199 - 101 Street  
Edmonton, Alberta T5J 3Y4

Dear Madam:

Re: Karlheinz Schreiber v. The Attorney General of Canada  
Q.B. Action #9703 20183

TANIA NORRIS  
Commissioner for Oaths  
My Commission Expires  
May 30, 2007

Further to your June 5, 2006 letter, this is to re-confirm that June 27, 2006 at 10:00 a.m., is the date upon which we will return to Court of Queen's Bench Chambers relative to our outstanding Notice of Motion.

By way of general response to your June 5, 2006 letter, it's quite clear to the writer, that "a fishing expedition" is being embarked upon in an effort to dissuade Mr. Schreiber from pursuing his legitimate claims as set out within the Amended Amended Statement of Claim, for example:

- a) Swiss banking records, records of contracts or undertakings in principle, are clearly irrelevant to the lawsuit.
- b) Banking records have been recognized by the Supreme Court of Canada as privileged and attract privacy protection section 8 *Charter of Rights*.
- c) Mr. Schreiber's business dealings are clearly irrelevant and not at issue.

On Examination for Discovery, there may well be some latitude, though confined to the allegations raised in the pleadings and not "fishing expeditions".

Yours truly,

HLADUN & COMPANY

*Dictated, but not read and signed  
in the writer's absence by:*

*Dr. Rosy chuk*  
f ROBERT W. HLADUN, Q.C.  
RWH/dr  
Via fax 495-6300 and mail



# KARLHEINZ SCHREIBER

The Right Hon. Brian Mulroney, P.C.,LL.D.

47 Forden Crescent  
Westmount Quebec

CANADA ...H 3 Y 2 Y 5

Ottawa July 20, 2006

Dear Brian,

Over the past three month I have learned a lot about the "monster" that has dogged our footsteps since 1994. Without a doubt, this is the biggest "Political Justice Scandal" in Canadian history.

The most recent statements under oath in court and during Examinations for Discovery have confirmed that Stevie Cameron, journalist, writer, confidential RCMP informant and complainant, had been passing information to the Mounties since 1988. She, together with a convicted Swiss criminal, Giorgio Pelossi, Canadian political figures and government officials are responsible for the "Political Justice Scandal" in Canada as well as in Germany and many other countries.

I also for the first time encountered a satisfying explanation regarding a very painful misunderstanding between us related to the "Bear Head Project".

You and I are the innocent victims of this vendetta and you are the still the prime target.

I have been trying since 1997 to bring the truth to light in a courtroom in Alberta, so far without success, due to the delay tactics of the Department of the Attorney General.

The "Political Justice Scandal" around the "Airbus Affair" will not go away by itself. The people behind the conspiracy must be exposed through determined actions and brought to justice. You and I have a responsibility towards our families, our friends, international companies involved, as well as to Canadians, to Canada and ourselves.

Despite the fact that I was very angry about the statements made by Norman Spector, Luc Lavoie and Bill Kaplan, I regret deeply that the people from the CBC's Fifth Estate were able to entrap me, just as they did so many others before me. This was possible with the help of an American journalist, whom I have trusted for a long time. He was misled, as was I.

MacKAY LAKE ESTATES  
7 BITTERN COURT, ROCKCLIFFE PARK  
OTTAWA, CANADA K1L 8K9  
Tel: 613-748-7330 Fax: 613-748-9697



I wish to tender my profuse apologies to you for the misleading, erroneous and unfair Characterization of your business relationship with me as depicted on the CBC program, "The Fifth Estate".

Without excusing my part, it is fair to say that I was misled by the producers that the program would deal with my complaints about the "sting" operation mounted against me by the RCMP.

May I state for the record, that my testimony under oath in prior legal proceedings is the only correct description of our business arrangement. You, after returning to private life, at my request, agreed to advise and consult me in certain business affairs.

I still believe that my statements in the book "The Secret Trial," together with my testimony under oath at the Eurocopter trial and my statements to Bob Fife, have made it crystal clear what my position is.

There is no "Airbus Affair" involving Brian Mulroney and furthermore there is nothing to hide.

The discussion and financial arrangements between you and me about future industrial projects have been correct, private and nobody's business. You were the best advocate I could have retained.

It is far too long since we had lunch together. I think it is wrong not to speak to each other. Too many people talk too much. I have not changed. I have always been your friend, even though I was irritated for some time, which I regret. For the sake of objectivity and fairness, I ask you to accept my apology.

I am happy that your health is fine again: so let us clear the air and bring peace to our families and ourselves.

Yours sincerely

A handwritten signature in black ink, appearing to read "Robert Fife", written in a cursive style.

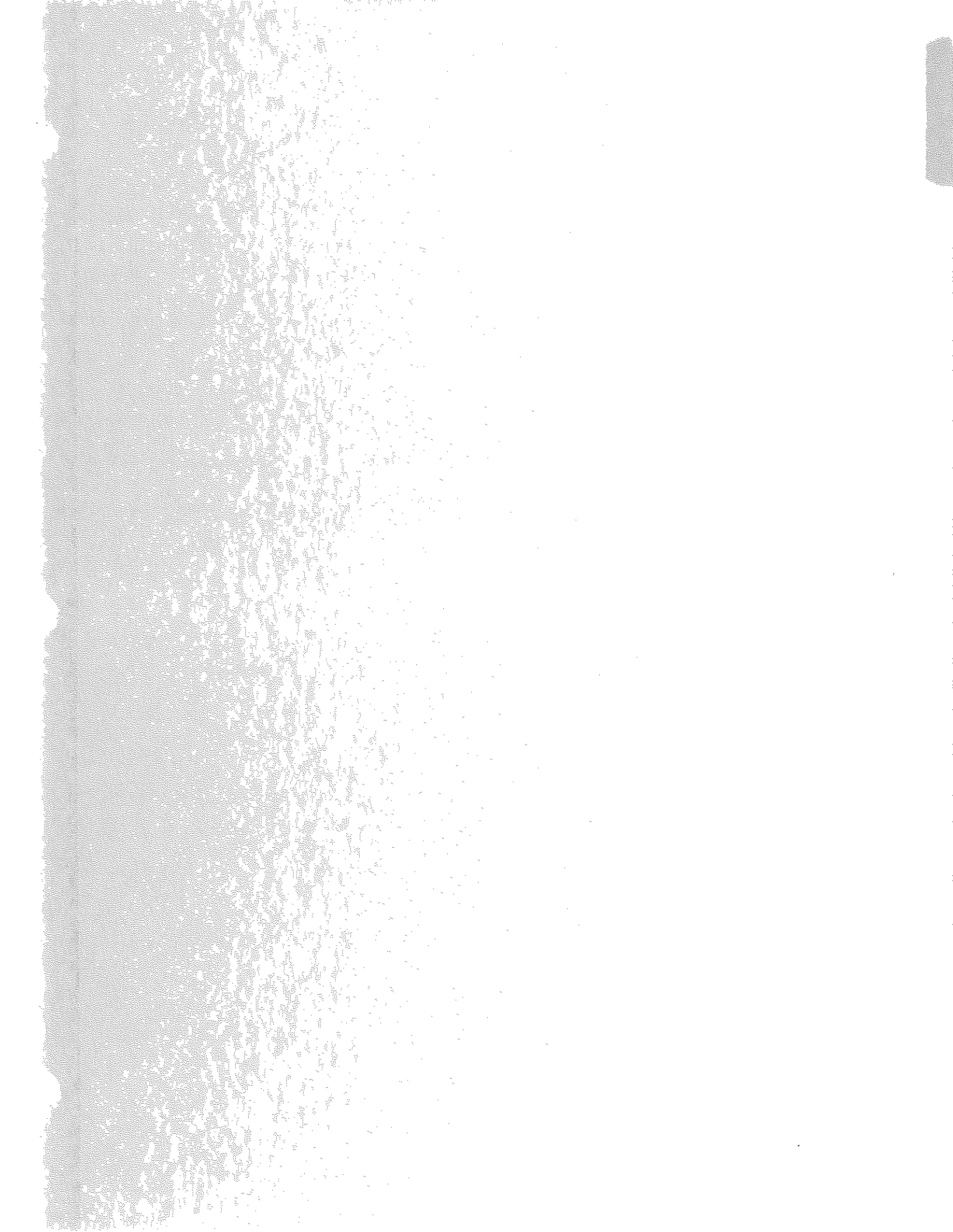

# KARLHEINZ SCHREIBER

The Right Hon. Brian Mulroney, P. C., LL. D.

47 Forden Crescent  
Westmount Quebec

CANADA H 3 Y 2 Y 5

Ottawa August 4, 2006

Dear Brian,

I am sending you via fax the copies of letters to  
The Right Hon. Stephen Harper, Prime Minister, July 31,2006  
The Hon. Peter Mackay, Minister of Foreign Affairs, July 25,2006  
Mr. Kevin Sorenson, July 25,2006  
For your personal Information.

Yours sincerely



MackAY LAKE ESTATES  
7 BITTERN COURT, ROCKCLIFFE PARK  
OTTAWA, CANADA K1L 8K9  
Tel: 613-748-7330 Fax: 613-748-9697

KARLHEINZ SCHREIBER

62140194

57e351

The Right Hon. Stephen Joseph Harper, P. C., M. P.  
Prime Minister

House of Commons  
Ottawa, Ontario  
K1A 0A6

Ottawa, July 31, 2006

Dear Prime Minister,

I am taking the liberty of sending you copies of my letters to

The Hon. Peter MacKay, P.C., M.P.                      July 25, 2006

Mr. Kevin Sorenson, M.P.                                July 25, 2006

for your personal information.

Yours sincerely,

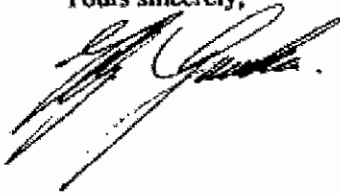

MacKAY LAKE ESTATES  
7 BITTERN COURT, ROCKCLIFFE PARK  
OTTAWA, CANADA K1L 8K9  
Tel: 613-748-7330 Fax: 613-748-9697

NS

# KARLHEINZ SCHREIBER

The Hon. Peter Gordon MacKay, P.C., M.P.  
Minister of Foreign Affairs and Minister of the Atlantic Opportunities Agency

House of Commons  
Ottawa, Ontario  
K1A 0A6

Ottawa, July 25, 2006

Dear Minister

I read with great interest the statements you gave in the House of Commons on May 27, 1998 and February 17, 1998. I attach six pages of your statements to this letter to refresh your memory and I am sure that you still endorse the same principles as you did at that time. I have underlined relevant portions of your statements.

You stated: "The government is faced with a very important issue, which relates directly to integrity and accountability.

Will the government do the right thing and call a public inquiry into the Airbus scandal? If the Prime Minister and the present Minister of Health had no roles in this affair, surely there is nothing to hide.

When this happens, Canadians will be allowed to finally see the truth".

Dear Minister unfortunately Canadians are still waiting for that moment to come. Nothing has changed. The biggest "Political Justice Scandal" in Canadian History with the most serious international implications is still moving ahead on several different places.

It looks like fate that both of your Ministries may have to deal with the "Political Justice Scandal".

Foreign Affairs:

The people who initiated the vendetta in Canada are the same in Germany and other countries. The German Conservatives lost two Federal Election and were forced into a great coalition with the Social Democrats after the last election. The Minister for Foreign Affairs and the one for Justice are Social Democrats. I am sure that Chancellor Angela Merkel will loose the next election, if the scandal continuous the way it is now.

ACOA:

The people behind the "Political Justice Scandal" are the same, which are responsible for the tremendous fraud on the Thyssen Krupp Bear Head Project in Nova Scotia. You are very familiar with the company, the project, (an ACOA Project) and the victims, which are the Canadian people in Nova Scotia, the Canadian Peacekeeping soldiers, ThyssenKrupp and myself.

MacKAY LAKE ESTATES  
7 BITTERN COURT, ROCKCLIFFE PARK  
OTTAWA, CANADA K1L 8K9  
Tel: 613-748-7330 Fax: 613-748-9697

On June 16, 2006 I wrote to the Right Hon. Stephen Harper and sent a number of relevant documents, which I enclose for your information.

On May 17, 2006 my Lawyer Edward L. Greenspan Q. C., LL. D., D. C. L. sent a letter to the Hon. Vic Toes Minister of Justice and Attorney General of Canada, which I provide for your attention. (See tap 18 in the folder "Political Justice Scandal" International Case.)

I wish you good luck and success with your difficult and important job.

Yours sincerely

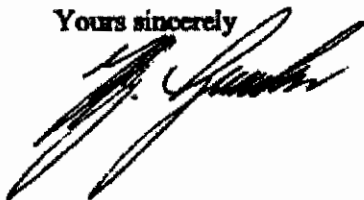

**Attachments:**

Letter to The Right Hon. Stephen Joseph Harper, Prime Minister June 16, 2006  
Letter to The Hon. Allan Rock, Minister of Justice January 20, 1997  
Letter from Department of Justice to Mr. Robert W. Hladun, Q. C. June 5, 2006  
Letter to Department of Justice from Mr. Robert W. Hladun, Q. C., June 22, 2006  
Letter to Department of Justice from Mr. Robert W. Hladun, Q. C., July 25, 2006  
Letter from Augsburg City Tax Office to Office of the Public Prosecutor Augsburg State Court August 2, 1995 (regarding Canadian Embassy)  
Letter from Edward L. Greenspan, Q. C., LL. D., C. L.

# KARLHEINZ SCHREIBER

Mr. Kevin Sorenson M.P.  
4945 - 50 Street

Camrose, AB  
T4V 1P9

Ottawa July 25, 2006

Dear Mr. Sorenson

I read with great interest the speech you gave in the House of Commons on October 22, 2001. I attach three pages of your speech to this letter to refresh your memory and I am sure that you still endorse the same principles as you did at that time. I have underlined relevant portions of your speech.

Your assumption that the "Airbus affair" could turn out to be a very big political scandal was correct, as it in my view combines the biggest "political justice scandal" in Canadian history with the most serious international implications.

The vendetta began in the early 1980s and has continued unabated. The main victims are the Canadian people, The Right Hon. Brian Mulroney and myself, Karlheinz Schreiber.

On June 16, 2006 I wrote to the Right Hon. Stephen Harper and sent a number of relevant documents, which I enclose for your information.

I wish you a pleasant stay in Alberta and remain,

Yours sincerely

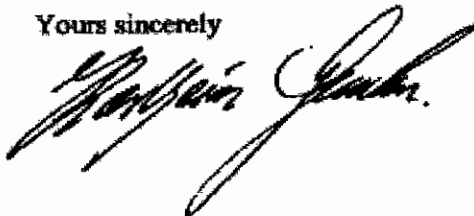

MacKAY LAKE ESTATES  
7 BITTERN COLIKT, ROCKCLIFFE PARK  
OTTAWA, CANADA K1L 8K9  
Tel: 613-748-7330 Fax: 613-748-9697



NS

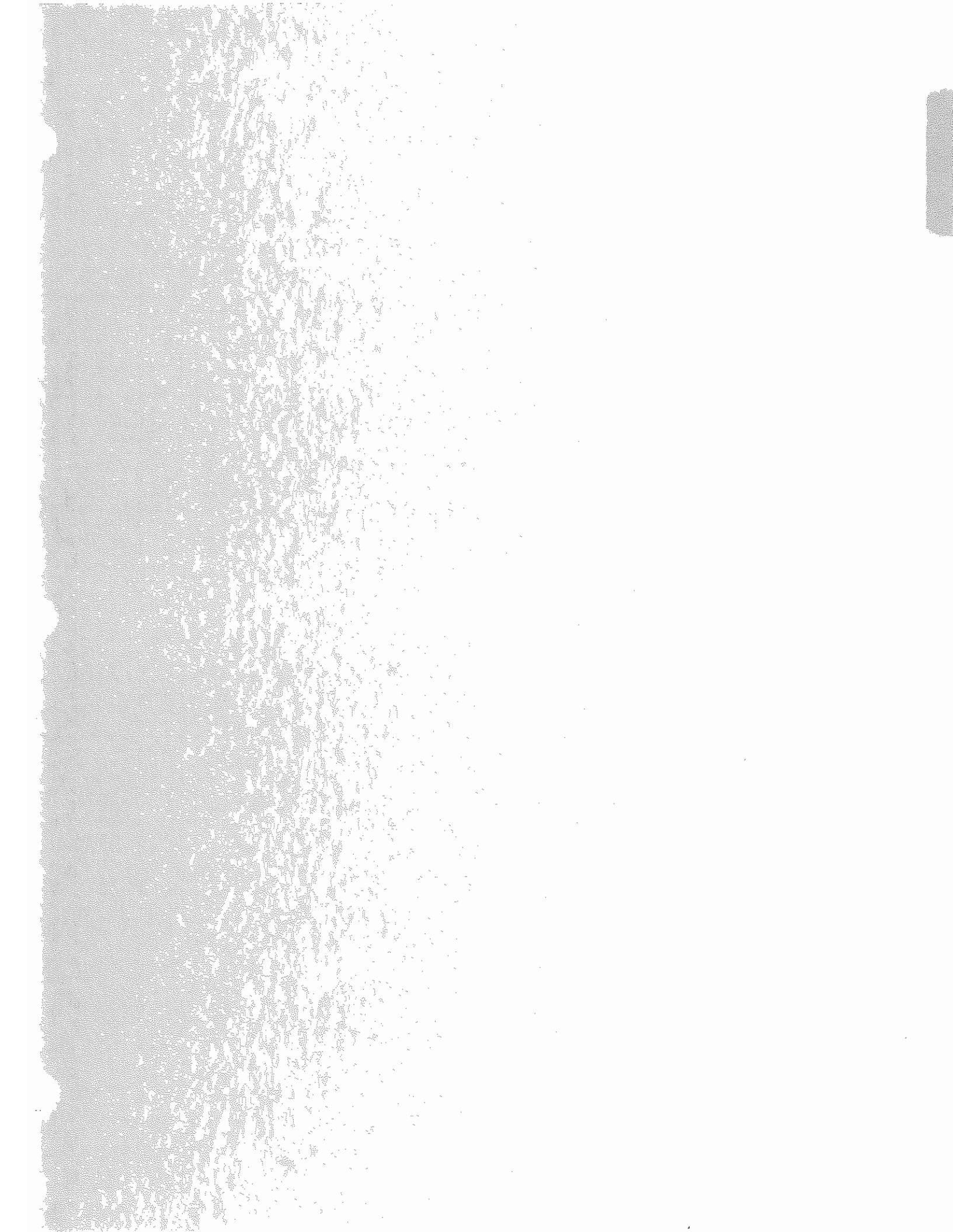

# KARLHEINZ SCHREIBER

The Right Hon. Brian Mulroney, P. C., LL. D.

47 Forden Crescent  
Westmount Quebec

CANADA H 3 Y 2 Y 5

Ottawa August 7, 2006

Dear Brian,

Please see the letters:

Dep. of Justice to Bob Hladun July 31, 2006

Bob Hladun to Dep. Of Justice July 25, 2006

Dep. Of Justice to Bob Hladun July 13, 2006 Read the request carefully and you will see, they will not give up. Not in this case and not in the MBB case or the secret trail case.

Yours sincerely





Department of Justice  
Canada

Ministère de la Justice  
Canada

Edmonton Regional Office  
211 Bank of Montreal Bldg  
10199 - 101 Street  
Edmonton, Alberta  
T5J 3Y4

Bureau régional d'Edmonton  
Edifice de la Banque de Montréal  
211 rue 101 - 10199  
Edmonton, Alberta  
T5J 3Y4

Telephone: (780) 495-6051  
Facsimile: (780) 495-6300

Internet: christine.ashcroft@justice.gc.ca

Our File: 2-90141  
Notre dossier:

Your File: 45890.1  
Votre dossier:

July 31, 2006

BY FAX

Hladun & Company  
Barristers and Solicitors  
100, 10187 - 104 Street  
EDMONTON, Alberta  
T5J 0Z9

Attention: Robert W. Hladun  
Fax # 424-0934

Dear Sir:

RE: Schreiber v. The Attorney General of Canada

Thank you for your letter requesting discovery of Mr. Allan Rock. We can advise that we object to any examination of Mr. Rock.

At common law, the Crown is not compellable at discovery. It is only through legislation that it may be compelled to discovery. Section 7 of the Regulations passed pursuant to the *Crown Liability and Proceedings Act* states that an officer or servant of the Crown may be designated for examination for discovery. The Court of Appeal has interpreted this section to mean that except for the right to examine a Crown designated officer, there is no machinery for examination for discovery as of right. See *CDIC v. Prisco*, (1997) 206 A.R. 283 (C.A.)

This decision was followed in *Milne and Milne v AG of Canada et al.*

Quite apart from the foregoing, there is case law regarding when a Minister may be examined. There must be special circumstances, and there must be no other person who is equally well-informed.

In any event, we will object to the examination of any person other than the Crown officer.

Yours truly,



**CHRISTINE A. ASHCROFT**  
Counsel  
Civil Litigation and Advisory Services

CAA/jr



Tel.780.423.1888 100, 10199 - 101 Street, Edmonton, AB T5J 3Y4  
Fax:780.423.5934  
www.hladun.ca

15737  
2-77605

July 25, 2006

Department of Justice Canada  
211, 10199 - 101 Street  
Edmonton, AB T5J 3Y4

Via Fax: 495-6300  
(Original retained)

Attn: Christine Ashcroft

Dear Madam:

Re: *Karlheinz Schreiber v. The Attorney General of Canada*  
Q.B. Action #9703 20183

Please be advised that we have been instructed to examine for discovery Allan Rock, as a former employee of the Defendants, pursuant to Rule 200(1)(c) of the Alberta Rules of Court. Accordingly, please contact the writer's assistant to make the necessary arrangements for this examination.

Yours truly,

HLADUN & COMPANY

Signed in the writer's absence to avoid delay  
ROBERT W. HLADUN, Q.C.  
KFS/ms

cc: Karlheinz Schreiber - via fax



Department of Justice  
Canada

Ministère de la Justice  
Canada

Edmonton Office  
Prairie Region  
211 Bank of Montreal Bldg  
10199 - 101 Street  
Edmonton, Alberta  
T5J 3Y4

Bureau d'Edmonton  
Région des Prairies  
Edifice de la Banque de Montréal  
211 rue 101 - 10199  
Edmonton, Alberta  
T5J 3Y4

Telephone: (780) 495-6051  
Facsimile: (780) 495-6300

Internet: christine.ashcroft@justice.gc.ca

Our File: 2-77605  
Notre dossier:

Your File:  
Votre dossier:

July 13, 2006

**BY FAX**

Hladun & Company  
Barristers and Solicitors  
100, 10187 - 104 Street  
EDMONTON, Alberta  
T5J 0Z9

Attention: Robert W. Hladun  
Fax # 424-0934

Dear Sir:

**RE: Schreiber v. The Attorney General of Canada  
Q.B. Action No. 9703 20183**

Enclosed for service upon you please find our Notice of Motion and Affidavit in this matter. We look forward to discussing it with you.

Yours truly,

**CHRISTINE A. ASHCROFT**  
Counsel  
Civil Litigation & Advisory Services

CAA/jr

Enclosures

Action No. 9703 20183

**IN THE COURT OF  
QUEEN'S BENCH OF ALBERTA  
JUDICIAL DISTRICT OF EDMONTON**

**BETWEEN:**

**KARLHEINZ SCHREIBER**

**Plaintiff**

**- and -**

**THE ATTORNEY GENERAL  
OF CANADA  
HER MAJESTY THE QUEEN IN  
RIGHT OF CANADA**

**Defendants**

**NOTICE OF MOTION**

Department of Justice Canada  
211 Bank of Montreal Building  
10199 - 101 Street  
Edmonton, Alberta T5J 3Y4

Per: Christine A. Ashcroft

Phone: (780) 495-6051

Fax: (780) 495-6300

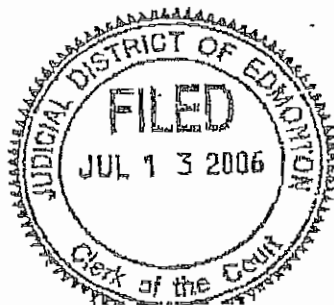



Action No. 9703 20183

IN THE COURT OF QUEEN'S BENCH OF ALBERTA  
JUDICIAL DISTRICT OF EDMONTON

BETWEEN:

KARLHEINZ SCHREIBER

Plaintiff

- and -

THE ATTORNEY GENERAL OF CANADA  
HER MAJESTY THE QUEEN IN RIGHT OF CANADA

Defendants

NOTICE OF MOTION

TAKE NOTICE that The Attorney General of Canada (the "Defendant") will make an application before the presiding Master in Chambers, on July 24, 2006 at the Court House, in Edmonton, Alberta, at 10:00 a.m., or so soon thereafter as counsel may be heard, for an Order:

1. Pursuant to Rule 196 of the *Alberta Rules of Court*, that the Plaintiff produce a further and better Affidavit of Records so as to include any and all relevant and material records within the possession, custody or power of the Plaintiff, on or before September 3, 2006, in default of which the Plaintiff's pleadings will be struck;
2. Costs of this Application, in any event of the cause, payable forthwith, pursuant to Rules 599.1 to 601; and
3. Such further and other relief as seems just to this Honourable Court.

AND FURTHER TAKE NOTICE that in support of this application the Defendant will rely on the following:

- (a) The pleadings in this action;
- (b) The Affidavit of Records of the Plaintiff, filed; and
- (c) The Affidavit of Joanne Romans, filed.

AND FURTHER TAKE NOTICE that the grounds upon which the Defendant relies in support of this application are:

1. The Plaintiff's Affidavit of Records does not disclose all of the relevant and material records that are or have been in the Plaintiff's possession, custody or power.
2. Such further and other grounds as counsel may advise and this Honourable Court will allow.

DATED at the City of Edmonton, in the Province of Alberta, this 3 day of July, 2006.

JOHN H. SIMS  
Deputy Attorney General of Canada

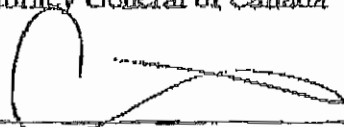
Per:   
CHRISTINE A. ASHCROFT  
Counsel for the Defendants  
Department of Justice Canada  
211 Bank of Montreal Building  
10199 - 101 Street  
Edmonton, Alberta T5J 3Y4  
Phone: (780) 495-6051  
Fax: (780) 495-6300

TO: Clerk of the Court

Action No. 9703 20183  
Sworn by Joanne Romains  
On this 13<sup>th</sup> day of July, 2006

**IN THE COURT OF  
QUEEN'S BENCH OF ALBERTA  
JUDICIAL DISTRICT OF EDMONTON**

**BETWEEN:**

**KARLHEINZ SCHREIBER**

**Plaintiff**

- and -

**THE ATTORNEY GENERAL  
OF CANADA  
HER MAJESTY THE QUEEN IN  
RIGHT OF CANADA**

**Defendants**

**AFFIDAVIT**

Department of Justice Canada  
211 Bank of Montreal Building  
10199 - 101 Street  
Edmonton, Alberta T5J 3Y4

Per: Christine A. Ashcroft

Phone: (780) 495-6051

Fax: (780) 495-6300

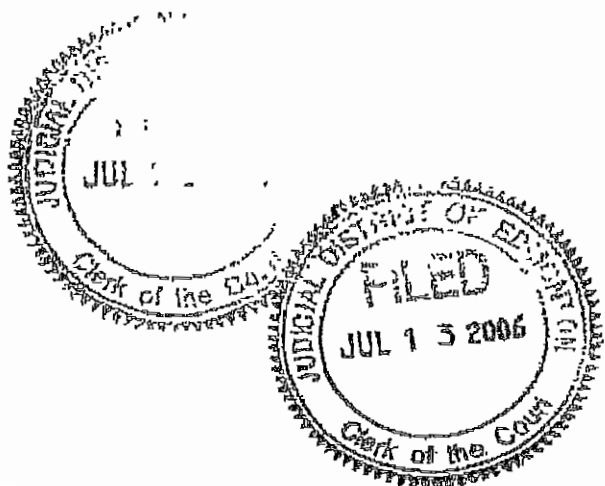

Action No. 9703 20183  
Sworn by Joanne Romans  
On this 13<sup>th</sup> day of July, 2006

**IN THE COURT OF QUEEN'S BENCH OF ALBERTA  
JUDICIAL DISTRICT OF EDMONTON**

**BETWEEN:**

**KARLHEINZ SCHREIBER**

**Plaintiff**

**- and -**

**THE ATTORNEY GENERAL OF CANADA  
HER MAJESTY THE QUEEN IN RIGHT OF CANADA**

**Defendants**

**AFFIDAVIT**

I, **JOANNE ROMANS**, of the City of Edmonton, in the Province of Alberta, Legal Assistant, **MAKE OATH AND SAY AS FOLLOWS:**

1. I am a Legal Assistant employed by the Department of Justice Canada. As such, I have a personal knowledge of the matters herein deposed to except where stated to be based on information and belief, in which case I verily believe the same to be true.
  
2. I am advised by Christine Ashcroft, counsel at the Department of Justice, that on June 5, 2006, she caused a letter, a true copy of which is attached as Exhibit "A" to this Affidavit, to be sent by facsimile to counsel for the Plaintiff.
  
3. I am further advised by Christine Ashcroft, and do believe, that she received a letter from counsel for the Plaintiff, dated June 22, 2006, a true copy of which is attached as Exhibit "B" to this Affidavit, in response to her letter.

4. I make this Affidavit in support of an intended application to this Court compelling the Plaintiff to file a Further and Better Affidavit of Records by September 3, 2006, and the other relief set out in the Notice of Motion to be filed in this matter.

SWORN BEFORE ME at the City of Edmonton, in the Province of Alberta on, the 13<sup>th</sup> day of July, 2006.

*Lynn Norris*

A Commissioner for Oaths in and for the Province of Alberta

T. A. NORRIS  
Com. Commissioner of Oaths  
M. Commission Expires  
June 30, 2008

)  
)  
)  
)  
)  
)

*Joanne Romans*  
JOANNE ROMANS

Canada

Edmonton Office  
Prairie Region  
211 Bank of Montreal Bldg  
10199 - 101 Street  
Edmonton, Alberta  
T5J 3Y4

Canada

Bureau d'Edmonton  
Région des Prairies  
Édifice de la Banque de Montréal  
211 rue 101 - 10199  
Edmonton, Alberta  
T5J 3Y4

Telephone: (780) 495-6051  
Facsimile: (780) 495-6300

Internet: sashcrof@justice.gc.ca

Our File: 2-77605  
Notre dossier:

Your File:  
Votre dossier:

June 5, 2006

BY FAX

Hladun & Company  
Barristers and Solicitors  
100, 10187 - 104 Street  
EDMONTON, Alberta  
T5J 0Z9

Attention: Robert W. Hladun  
Fax # 424-0934

Dear Sir:

RE: Schreiber v. The Attorney General of Canada

I am assisting Jim Shaw with this file.

I understand that you have asked us to produce our documents.

We have reviewed Mr. Schreiber's Amended Amended Statement of Claim, and the Affidavit of Records. If this action is to proceed, our view is that Mr. Schreiber will need to file a further and better Affidavit of Records.

Below, we speak of the Statement of Claim, but in each case are referring to the Amended Amended Statement of Claim.

Referring to para. 12 of the Statement of Claim, we understand that Mr. Schreiber received some sort of notification of the Swiss authorities' request for banking records from the Swiss Union Bank. Mr. Schreiber should disclose the documents related to the notification in his Affidavit.

As you know, Mr. Schreiber is responsible to produce documents which are or were in his custody and control, which includes documents of companies which he owns or controls, or has owned or controlled. We understand that Mr. Schreiber conducted his business through several companies. Mr. Schreiber will need to produce any relevant and material documentation from these companies. Such documents would include, but not be limited to, records of contracts or understandings in principle between Mr. Schreiber's companies and such companies as MBB, Thyssen Industrie AG, Airbus Industrie, and Bear Head Manufacturing Industries BMI Inc.

This is Exhibit "A" referred to in the  
Affidavit of

Joanne Romans

Sworn before me this 13th day

of July A.D., 2006

Tania Norris  
A Notary Public, A Commissioner for Oaths  
in and for the Province of Alberta

TANIA NORRIS  
Commissioner of Oaths  
My Commission Expires  
May 30, 2009

Canada

- 2 -

Documents held by Mr. Schreiber's lawyers or ex-lawyers remain within Mr. Schreiber's possession or control, and therefore Mr. Schreiber should produce non-privileged documents relevant to this matter which are in the possession of Mr. Schreiber's lawyers or ex-lawyers, including Peter Widmer.

Referring to para. 12 of the Statement of Claim, Mr. Schreiber should have banking records which relate to this matter. Such documents would include banking records from Verwaltungs-Und Private Bank in Vaduz, Liechtenstein. Banking records of companies controlled by Mr. Schreiber which relate to the allegations in the Statements of Claim and Defence are also relevant to this matter.

The documents would also include bank documents showing payments from MBB, Thyssen, Airbus Industria, and Bear Head Manufacturing to IAL or other companies controlled by Mr. Schreiber, and payments from companies controlled by Mr. Schreiber to persons such as Mr. Moores and Mr. Schreiber, or companies such as Consultants International Incorporated.

You have said in discoveries that the ownership of IAL was by bearer certificate. Mr. Schreiber should be able to produce the bearer certificate or advise when it left his possession. There should be other relevant IAL documents. Even if some of them are no longer in Mr. Schreiber's possession or control, they should be listed in the Affidavit.

Referring to para. 14 and 15 of the Statement of Claim, Mr. Schreiber should have a copy of the letter of apology, and his own letter to the Deputy Attorney General and the Commissioner of the RCMP, and any letter he received in response. If he has other correspondence related to his alleged efforts to obtain apologies or revisions to Crown documents, that documentation should be produced.

Referring to para. 20 of the Statement of Claim, we understand that Mr. Schreiber says that he did pay some money to Brian Mulroney. He should produce documentation related to those payments.

Referring to para. 20 of the Statement of Claim Mr. Schreiber states there was no criminal activity as set out in the Letter of Request, or at all. He has denied criminal activity. He has put all of his business dealings into issue. He has also made many public statements, or responded in books and interviews. Mr. Schreiber must inform himself of all of that and disclose all documents relating to the matter which are relevant and material to this lawsuit.

At para. 30 of the Statement of Claim, the Plaintiff alleges that he has lost economic opportunity and income. He must have documentation in relation to that claim, and he will need to produce it.

At para. 19 of the Amended Statement of Defence, we allege that Mr. Schreiber provided Mr. Mulroney with a copy of the German version of the Letter of Request. If Mr. Schreiber has or had a copy of the German version, it should be set out in his Affidavit.

- 3 -

In *Germany v Schreiber*, before Mr. Justice Watt, there is reference to Mr. Schreiber's personal organizer. Documentation from the organizer which is material to this lawsuit must be produced.

Further, your client has been involved in many lawsuits related to this matter. All documentation which he or his counsel has received in these lawsuits is now within his possession or control, and must be produced in this matter. For example, Mr. Schreiber sued CBC, and should have documents produced during that lawsuit for disclosure, as well as documentation of his own related to that lawsuit which is also relevant and material to this lawsuit.

Some time has elapsed since 2003. Your client will likely have new relevant and material documentation in his possession, which should be added to his production.

Of course, we are unable to know exactly what relevant and material documents your client has in his possession or control. Clearly, however, his present Affidavit of Records is deficient.

We know you will review Mr. Schreiber's responsibilities respecting document production with him, to ensure compliance with his legal obligation to locate, gather, and produce all documents material and relevant to this matter. No doubt there are more material and relevant documents beyond what we have requested in this letter.

We look forward to receiving your filed further and better Affidavit of Records.

Yours truly,

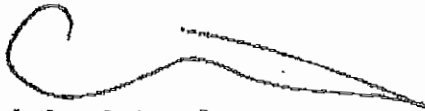

Christine Ashcroft  
Counsel

jr





Tel. 780.423.1888  
Fax 780.424.0974  
www.hladun.com

100 Street, 101 Street  
Edmonton, Alberta  
T5J 3Y4

15737

our file

2-77605

June 22, 2006

This is Exhibit "B" referred to in the Affidavit of

Jeanne Romans

Sworn before me this 13th day

of July A.D., 2006

Tania Norris  
A Notary Public, A Commissioner for Oaths  
in and for the Province of Alberta

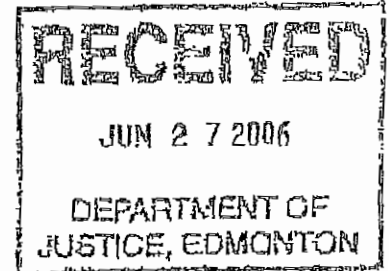

Ms. Christine Ashcroft  
Department of Justice Canada  
#211, 10199 - 101 Street  
Edmonton, Alberta T5J 3Y4

Dear Madam:

Re: *Karlheinz Schreiber v. The Attorney General of Canada*  
Q.B. Action #9703 20183

TANIA NORRIS  
Commissioner for Oaths  
My Commission Expires  
May 30, 2007

Further to your June 5, 2006 letter, this is to re-confirm that June 27, 2006 at 10:00 a.m., is the date upon which we will return to Court of Queen's Bench Chambers relative to our outstanding Notice of Motion.

By way of general response to your June 5, 2006 letter, it's quite clear to the writer, that "a fishing expedition" is being embarked upon in an effort to dissuade Mr. Schreiber from pursuing his legitimate claims as set out within the Amended Amended Statement of Claim, for example:

- a) Swiss banking records, records of contracts or undertakings in principle, are clearly irrelevant to the lawsuit.
- b) Banking records have been recognized by the Supreme Court of Canada as privileged and attract privacy protection section 8 *Charter of Rights*.
- c) Mr. Schreiber's business dealings are clearly irrelevant and not at issue.

On Examination for Discovery, there may well be some latitude, though confined to the allegations raised in the pleadings and not "fishing expeditions".

Yours truly,

**HLADUN & COMPANY**

*Dictated, but not read and signed  
in the writer's absence by:*

*D Rosy chuk*

ROBERT W. HLADUN, Q.C.

RWH/dr

Via fax 495-6300 and mail

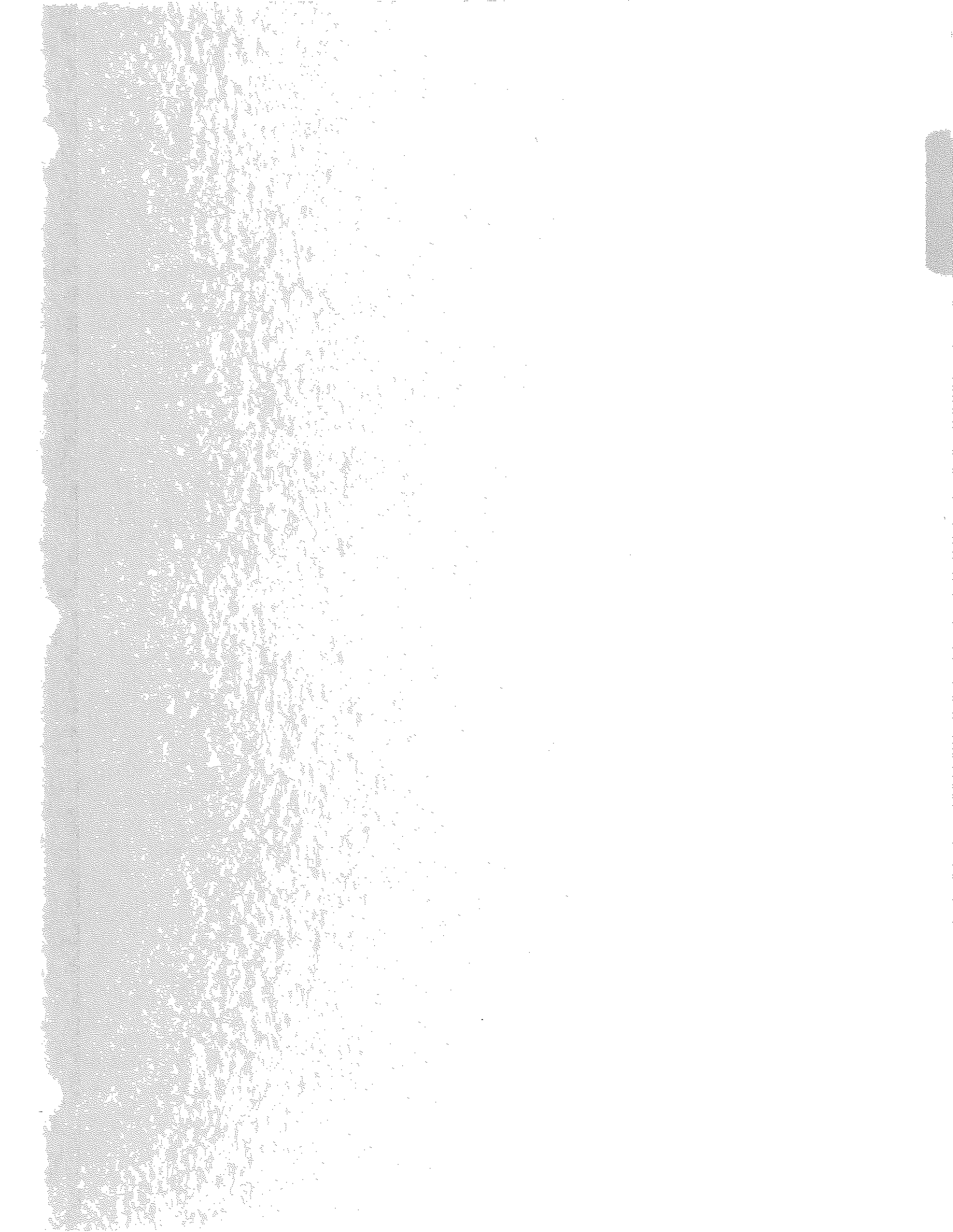

02/03/06

---

KARLHEINZ SCHREIBER

The Right Hon. Brian Mulroney, P. C., LL. D.

47 Forden Crescent  
Westmount Quebec

CANADA H 3 Y 2 Y 5

Ottawa August 9, 2006

Dear Brian,

It looks like the whole case is more dangerous and sinister when I see new information regarding the enormous power of the (IAG) International Assistance Group ( see the attached document RCMP. Interpol I – The Canadian Central Authority.

I underestimated totally the unbelievable power of Kimberly Prost, Director of the IAG, the only route to the Minister.

She started the action against you and me without any evidence in Switzerland and Germany simultaneously (see the attached documents, regarding the Canadian Embassy in Germany and Liaison officer Brettschneider and Liaison officer McLean at the Canadian Embassy in Bern Switzerland).

On June 22, 1999 my lawyer Erich Samson approached prosecutor Nemetz in Augsburg and tried to cut a deal with him. During the conversation Prof. Samson reminded Mr. Nemetz that tax evasion is not an offense for extradition under the treaty between Germany and Canada. The response from Mr. Nemetz was: "We are going to get Schreiber. The Canadians have a new extradition act and behind the case is a Minister, who wants to get Schreiber out of the country as soon as possible."

On August 31, 1999 I was arrested in Toronto based on an arrest-warrant for tax evasion. Since the arrest-warrant did not satisfied the Canadian authorities, the prosecutor in Augsburg issued another arrest-warrant on Sept. 2, 1999 and added accusations of fraud, breach of trust and bribery. From the 11<sup>th</sup> to the 15<sup>th</sup> of Sept. 1999 and from the 4<sup>th</sup> to the 9<sup>th</sup> of Oct. 1999 some Canadian lawyers from the IAG were in Augsburg and fabricated the record of the case for my extradition from Canada. The document shows the date . Oct. 11, 1999. The document was sent to the IAG and an authority to proceed was issued by IAG on behalf of the Minister of Justice. The IAG is acting for the German prosecutors and at the same time for the Canadian Minister of Justice until today despite the fact of my pending lawsuit against the Canadian Attorney General and the IAG

Under the new EXTRADITION ACT the IAG represents the greatest example of conflict of interest that one could ever imagine. They believe they are a law unto themselves.

MacKAY LAKE ESTATES  
7 BITTERN COURT, ROCKCLIFFE PARK  
OTTAWA, CANADA K1L 8K9  
Tel: 613-748-7330 Fax: 613-748-9697

Please look at her Biographical Note Judge Kimberley Prost and you will easily see the political difference between Right Hon. Brian Mulroney, Franz Josef Strauss, Helmut Kohl and Karlheinz Schreiber. You can also see that she was a Federal Prosecutor in Winnipeg from June 1982 until June 1989.

The Hon. Vic Toews practiced law with the Manitoba provincial Department of Justice from 1976 to 1991

She together with the IAG, the Hon Allan Rock, the RCMP together with Stevie Cameron, their Confidential Informant, Complainant and other unknown members from the Canadian Underground Government (we experienced already with the Bear Head Project) are part of a huge conspiracy against you, Frank Moores, Gary Ouelett. and myself. Only you and I are left.

My lawsuit in Edmonton is the reason why they are hunting me everywhere, knowing that I will not loose and that, the truth coming to light will be a catastrophe for them. Therefor I have to be extradited to their Conspiracy-Partners in Germany who like to use me for political reasons.

My lawsuit in Edmonton against the Attorney General of Canada is the historical chance for the Canadians to get to know the truth regarding the "Airbus" affair, the biggest "Political Justice Scandal" in Canadian history and the Canadian Underground Government.

The public information regarding the lawsuit in Edmonton would most certainly shock the conscience of Canadians and could very well be the reason for the Conservative Government of the Right Hon. Stephen Harper not to become just an interim Conservative Government like all the others in Canadian History.

It is a great pleasure and honor to tell you that the Hon. Jack Major, who has been my lawyer and true friend for many years, has become my lawyer again after he retired from the Supreme Court of Canada.

The team ready to battle the lawsuit in Edmonton is now:

Mr. Edward L. Greenspan, Q.C., LL. D., D. C. L.

The Hon. Jack Major Q. C., LL. D.

Mr. Robert Hladun Q.C.

Now it is up to the Right Hon. Stephen Harper, Prime Minister of Canada to provide his support to the greatest Government-Cleanup in Canadian History.

I trust I have your support to bring the terrible Vendetta to an end.

Yours sincerely



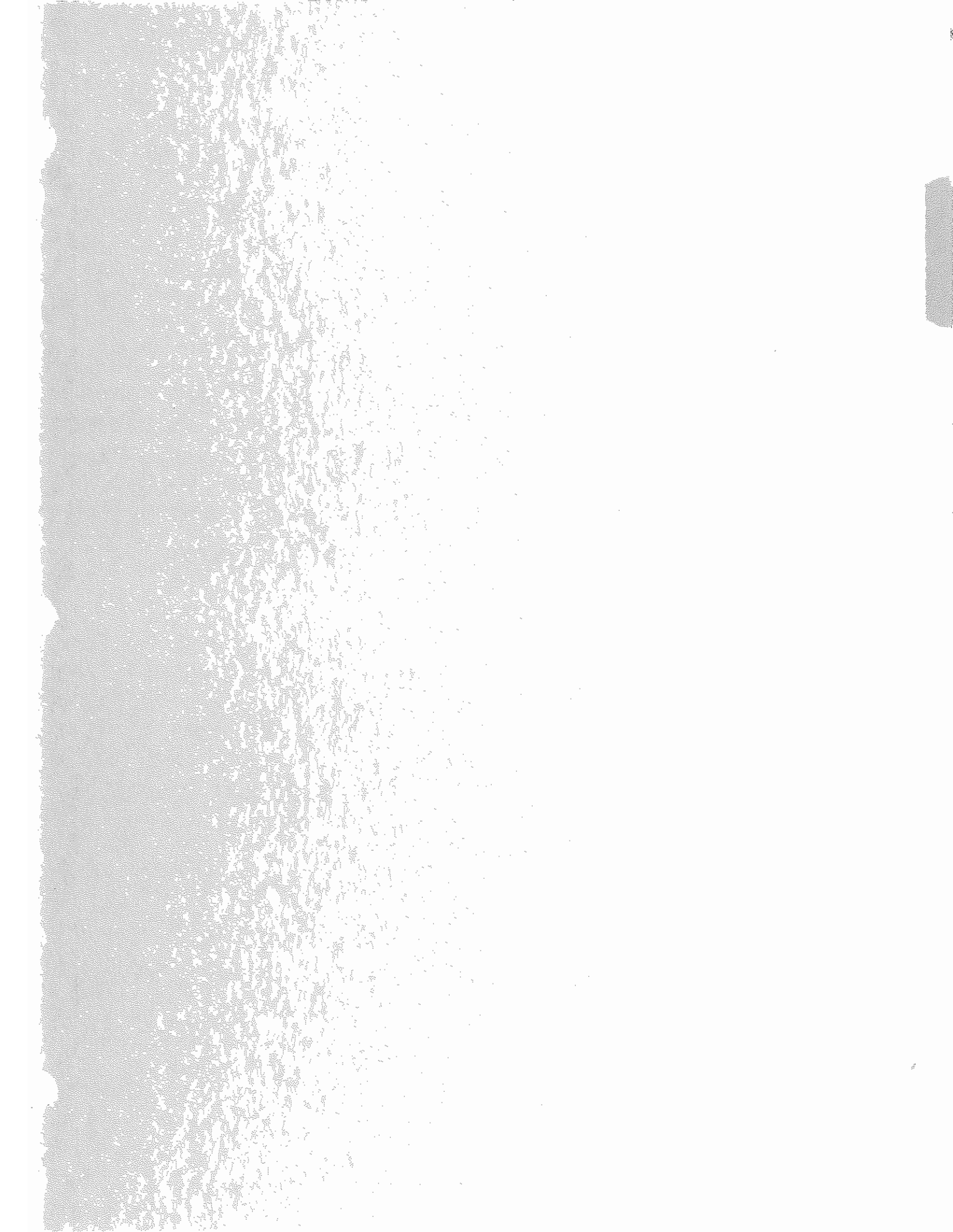



To: The Right Hon. Brian Mulroney

From: **Karlheinz Schreiber , Fax Number 416 935 1418**

Date: August 10, 06 Number of Pages 16 including this cover page

◆  
If you have any problems or questions regarding this transmission,  
please call 416 578 4022

◆  
Dear Brian,

I send you some more documents regarding  
correspondence between Edward Greenspan Q.C.  
and the Ministers of Justice for your information.

Yours sincerely

*Karlheinz Schreiber*





To: The Right Hon. Brian Mulroney

From: **Karlheinz Schreiber , Fax Number 416 935 1418**

Date: August 10, 06 Number of Pages 11 including this cover page

◆  
If you have any problems or questions regarding this transmission,  
please call 416 578 4022

◆  
Dear Brian,

I am sorry but I was unable to finish the case-report earlier! But I think, the information is very important for you! Please believe me! This is no case of tax evasion.

It is a political conspiracy and became a question of life or death for us. Please take it the way I say it!

Yours sincerely  
friend Karlheinz





FAX TRANSMISSION

To The Right Hon. Brian Mulroney  
Fax: 1-514-369-9393

From: **Karlheinz Schreiber, Canada** Fax **416 935 1418**

Date 18. Aug. 2006 Number of Pages 13.....including this cover page

If you have any problems or questions regarding this transmission

Please call 416 578 4022

Dear Brian,

I take the liberty to provide you  
with a corrected version of my letter  
from August 9th to you and my case report  
from August 6, 2006. Have a nice weekend.

Sincerely

Karlheinz



# KARLHEINZ SCHREIBER

The Right Hon. Brian Mulroney, P. C., LL. D.

47 Forden Crescent  
Westmount Quebec

CANADA H 3 Y 2 Y 5

Ottawa August 23, 2006

Dear Brian,

Here is the final version which was sent to the Prime Minister.

We found unbelievable new material, regarding the "Political Justice Scandal" with the involvement of Mr. David Corbett.

Yours Sincerely,



KARLHEINZ SCHREIBER

7 BITTERN COURT, ROCKCLIFFE PARK  
OTTAWA, CANADA K1L 8K9

THELEPHON: 613 748 7330  
FACSIMILE: 613 748 9697  
schreiberbarbel@aol.com

The Right Hon. Stephen Joseph Harper  
Prime Minister

House of Commons  
Ottawa, Ontario  
K1A 0A6

Ottawa, August 23, 2006

**Subject: "Political Justice Scandal"**

Dear Prime Minister,

I am taking the liberty to send you a copy of the Case Report on the  
"Political Justice Scandal" International Case and the "Airbus" Affair,  
August 20, 2006 for your convenience.

The Case Books I send to you on June 17, 2006 contain the evidence and substantiate  
the Case Report.

The document confirms the content of my letter to you from June 16, 2006 and the reason  
why I can only turn to you.

I wish you success in the interest of all Canadians.

Yours sincerely

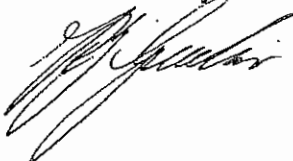

# **“Political Justice Scandal” International Case And the “Airbus” Affair**

## **Case Report**

Ottawa, August 20, 2006

The case began as the “Airbus” affair. It turned quickly to become the biggest “Political Justice Scandal” in Canadian history with the most serious international implications.

The initiators of the scandal are: The Canadian Justice System (C. J. S.) including The Hon. Allan Rock, then the Minister of Justice and Attorney General of Canada, The Hon. Herb Gray, then the Solicitor General of Canada, Stevie Cameron a confidential RCMP informant and complainant, journalist and writer with the support of Kimberly Prost, Senior Counsel, then the Director, International Assistance Group for the Minister of Justice of Canada, the RCMP and a convicted Swiss criminal Giorgio Pelossi.

The vendetta against The Right Hon. Brian Mulroney and the Tories started after The Hon. Allan Rock was having dinner with the Globe and Mail reporter Susan Delacourt in the fall of 1993.

On June 14, 1996 The Right Hon. Stephen Harper, Prime Minister, then M.P (Calgary West, Ref) during Commons Debates:

*Mr. Speaker, that kind of hair-splitting could only be done by a lawyer. I am citing an article in the Toronto Sun yesterday where it says that Globe and Mail managing editor Colin MacKenzie said that Rock approached parliamentary journalist Susan Delacourt for help in his behind the scenes probe of Mulroney one or two days after he first heard about allegations from an other journalist. My question is very simple. Going back to the beginning of this affair, why was the Minister of Justice conducting his own private investigation?*

When Stevie Cameron’s book *On the Take* hit the best-seller lists in 1994, Liberals in Ottawa took to calling Cameron “Stevie Wonderful”. When Solicitor Herb Gray read it, he made sure that the RCMP were reviewing it carefully, to see if any investigation was warranted.

(An article from Saturday Night, October 1, 1996: *Vicious Circle – Media's Role in the Airbus Scandal Involving Brian Mulroney* is important to read.)

A letter from the Augsburg City Tax Office (Germany) to the office of the Public Prosecutor on August 02, 1995 confirmed that the C J S through the Canadian Embassy in Germany was, since May 24, 1995, in contact with the Senior Prosecutor Kolb and informed the authorities in Augsburg about their apparent investigation in Switzerland.

On July 24, 1995 the Augsburg tax investigators met with Giorgio Pelossi in Bregenz, Austria, to receive information on I. A. L. business. Because of the risk to be arrested Pelossi did not come to Augsburg.

On August 24, 1995 RCMP Inspector McLean, Liaison Officer Canadian Embassy Bern, Switzerland, writes to Kimberly Prost, Department of Justice, how to draft the Letter of Request to Switzerland to alleviate any problem *vis a vis* RCMP contact with a witness.

On September 6, 1995 G. Pelossi informed the tax investigators in Augsburg that Sergeant Fraser Fiegenwald and Inspector Yves Bouchard are the RCMP officers investigating in Switzerland. On September 11, 1995 the two officers met with the prosecutors in Augsburg and agreed to compare notes. (Read Cameron, *The Last Amigo*, page 260 about the illegal contact with a witness in Switzerland)

Kimberly Prost and the International Assistance Group(IAG) fabricated the Letter of Request to the Competent Legal Authority of Switzerland based on the stories from Giorgio Pelossi, without any real evidence but a lot of lies.

## **Giorgio Pelossi**

On December 12, 1995 RCMP Inspector Gene McLean, acting as Liaison Officer at the Canadian Embassy in Bern, Switzerland informed the authorities in Ottawa that Giorgio Pelossi had a criminal record, being convicted on June 6, 1995 for a false accusation. Pelossi was sentenced on December 24, 1996 to three month detention, suspended for a two year period for embezzlement, specifically for wrongfully investing money for his own profit between 1984 and 1986.

On September 11, 1986 Pelossi was arrested by Swiss Police and detained for six month without charge. He was suspected of swindling money from a bank account belonging to someone laundering drug money for the Mafia. The prosecutor was Carla del Ponte, now Chief UN War Crimes Prosecutor. On January 22, 2000 Pelossi was arrested and detained by the police in Chicago in connection with Italian drug-trafficking charges.

The presiding Judge Maximilian Hofmeister together with 4 other judges and some prosecutors from the Augsburg Regional Court were traveling several times to Zuerich, Switzerland to examine Giorgio Pelossi. Pelossi cannot leave Switzerland because of the Italian arrest warrant against him. Switzerland will not extradite its Nationals.

## **M. B. B. AND THYSSEN**

Based on the information from Giorgio Pelossi and the Canadian officials, the Augsburg prosecutors were granted warrants to search the offices of M.B.B., Messerschmitt – Boelkow – Blohm on August 2, 1995 and the offices of Thyssen – Industrie on August 14, 1995. The search of the offices of Thyssen - Industrie disclosed unrelated matters to the accusations, which finally led to the "C.D.U. Donation Scandal"

## **The Letter of Request to Switzerland**

On September 29, 1995 Kimberly Prost, Senior Counsel Director International Assistance Group (IAG) Department of Justice Canada has sent the Letter of Request for Assistance from Canada to Switzerland in the Matter of Frank Moores and Martin Brian Mulroneu to the Canadian Embassy in Bern, Switzerland. Kimberly Prost asked Insp. McLean, RCMP Liaison Officer at the Canadian Embassy, to present the letter to the appropriate authorities in Switzerland.

On October 26, 1995 Swiss officials seize the bank accounts and safety deposit boxes of Frank Moores and Karlheinz Schreiber.

## **Bayerische Bitumen Chemie**

On October 5, 1995 German Police raid the Company and the home of Karlheinz Schreiber in Kaufering, Germany and seize documents. The raid is in connection with an investigation into suspected tax evasion.



## International Cooperation

On April 30, 1996, Stevie Cameron, confidential RCMP informant, journalist and writer met with Senior Public Prosecutor Hillinger and Prosecutor Weigand in Augsburg, Germany. During the meeting Stevie Cameron provided documents regarding Canadian Companies of the suspect Mr. Karlheinz Schreiber, a copy of a newspaper article: "Arms and the Woman" and a copy of her book *On the Take*, which all has been placed on the file. Around the same time she met for some days with Giorgio Pelossi, the Swiss convicted criminal.

In the same month, Canadian tax officials were beginning to work together with their German counterparts. Stevie Cameron, the confidential RCMP informant reports in *The Last Amigos* at p. 285: On June 4, 1996 two Revenue Canada officers, Bruce Findlay and Guy Bigonnesse, met in Augsburg with the tax investigators Gumpendobler, Kindler and others to share intelligence. They swapped binders of confidential tax information.

## The Legal Battle

On November 20, 1995 the Right Hon. Brian Mulroney filed a \$50 million lawsuit against the Canadian Government and the RCMP.

On January 9, 1997 the Government of Canada, The Hon Allan Rock, then Minister of Justice and Attorney General of Canada and Philip Murray, then Commissioner, of the RCMP have sent a letter of apology to Karlheinz Schreiber and informed him about the settlement agreement of January 5, 1997 with the Right Hon Brian Mulroney.

Karlheinz Schreiber thought at that time- and thinks that he is proven right today- that it was a mistake to settle the lawsuit. He also believed at that time and feels the same way today that the statement by The Hon. Allan Rock and The Hon. Herb Gray, regarding the case of the *Right Hon. Brian Mulroney v. The Attorney General of Canada* on Monday, January 6, 1997 (see attached document) is a totally unacceptable insult and a historical lie in its dimension.

This political vendetta has cost the Canadian taxpayer millions of dollars so far and will cost much more because the case has not come to an end after 11 years and is still moving ahead, driven by the enormous fear of the individuals, responsible for the biggest "Political Justice Scandal" in Canadian history.

On January 20, 1997 Karlheinz Schreiber has sent a letter to Hon Allan Rock, then Minister of Justice and Attorney of Canada and to Phillip Murray, then Commissioner of the RCMP.

In his letter Karlheinz Schreiber explains, why the Minister's letter is pure nonsense and a pack of lies. The last paragraph No 9 of his letter: "I recognize your apology but this matter will only be properly clarified in a courtroom. This is my understanding .I have been a judge for commercial matters for nine years in Munich."

On January 30, 1997 Schreiber's lawyer Robert Hladun Q C., Edmonton, sent a letter to Hon.Allan Rock and Philip Murray, RCMP. Page 6 of the letter reads:

*We have learned that the Swiss Government still labours under the impressions created by the original Request, together with all the accusations and indictment therein that now have been shown or proven to be erroneous, false and untrue.*

*In the event that the Government of Canada fails to recognize the above and officially withdraw / revoke the said Request, it is the intention of Mr. Karlheinz Schreiber to seek the appropriate legal remedy before the appropriate legal forum to resolve all of those issues that have arisen since the issuance of the said Request.*

*Therefore, we respectfully request an immediate reply not later than seven days from the date of this letter.*

**Neither Mr. Hladun, Q. C. nor Mr. Schreiber received an answer to their letters.**

On October 24, 1997 Mr. Schreiber filed a \$35 million lawsuit against the Canadian Government.

Since the Right Hon. Brian Mulroney entered a settlement agreement with the Canadian Government, Mr. Schreiber's lawsuit is the only legal avenue, which would shed light to the unbelievable political vendetta and the biggest frightening "Political Justice Scandal" in Canadian history.

At the same time Mr. Schreiber's lawsuit is the greatest threat to all the responsible politicians and government officials, who were or are still involved in the case. Canadians from coast to coast will be shocked and scared when the truth of the case will come to light and when it will be known what all was done by the Department of Justice to avoid the truth to be seen.

The alternative to the Schreiber lawsuit would have been a publicly commissioned inquiry as unsuccessfully requested by several M.P.'s in the House of Commons.

On December 3, 1997 Mr. Jack Ramsay M. P. (Crowfoot, Ref.) made a motion to the Standing Committee on Justice and Human Rights.

The questions he raised are still unanswered and very interesting to read. The document attached contains also very important statements regarding the Brian Mulroney and Karlheinz Schreiber cases from:

Messr. Gilles Duceppe M.P. (Laurier-Sainte-Marie, B.Q.)  
 Mr. Peter MacKay M.P. (Pictou-Antigonish-Guysborough, P.C.)  
 Mr. Garry Breitkreuz M.P. (Yorkton-Melville, Ref.)  
 Messr. Michel Bellehumeur M.P. (Bertier-Montcalm, B.Q.).

**Mr. Breitkreuz stated: "The confidence of Canadians in their institutions and the justice system is at stake."**

**Today, 8 years and 7 months later Canadians still do not know what happened and what is still ongoing with the case.**

## **Attempt to stop the Lawsuit**

To avoid the disclosure of the "Political Justice Scandal" through the Schreiber lawsuit, the Justice Department and the R.C.M.P. have chosen different defence measures for their face-saving action.

1. Delay actions since 1997 regarding the lawsuit proceedings in Edmonton.
2. The M.B.B. fraud case.
3. RCMP undercover operation.
4. The German Extradition Request for Karlheinz Schreiber

**All of these activities raise one question: What have they done and try to hide under all circumstances? Why have these people acted at all costs to suppress the truth?**

**Mr. Schreiber is convinced that his lawyers will make sure that the secrets of the biggest "Political Justice Scandal" in Canadian history will come to light.**

**The lawyers dealing with this task are:**

**Mr. Edward L. Greenspan, Q.C., LL. D., D.C.L.**  
**The Hon. Jack Major, Q.C., LL.D.**  
**Mr. Robert W. Hladun, Q.C.**

### **1 Delay actions regarding the lawsuit**

Since 1997 the Department of Justice has tried to delay the proceedings of the lawsuit by requesting more and more documents from Mr. Schreiber regarding business matters clearly irrelevant and not at issue. The requests are part of permanent “fishing expeditions,” related to the Right Hon. Brian Mulroney. It looks like the Department of Justice wants to start a new investigation in a file the RCMP closed in April 17, 2003.

The Department of Justice failed to provide better affidavits of documents and undertakings from discovery examinations and refused to send documents to their own lawyers in Edmonton. The aim is clearly to keep the lawsuit away from the court because there is no chance to win the case, since the R.C.M.P. closed the file on the fact that there was no evidence of wrongdoing.

**The main reason to keep the case away from a public trial in the courts is the fear of disclosure and personal consequences.**

### **The M.B.B. fraud case**

The M.B.B. fraud case is the only thing that was left from the accusations in the foolish Letter of Request to Switzerland on September 29, 1995, starting the “Airbus” affair, which is the legal basis for the lawsuit.

The Attorney General of Canada, the International Assistance Group (IAG) of the Canadian Department of Justice and the R.C.M.P., who fabricated the Letter of Request need the insane M.B.B. fraud case to claim that there is an ongoing investigation to avoid any access to information.

For the same reason the Crown appealed the ruling of Mr. Justice Paul Belanger of the Ontario Court of Justice, who has thrown out fraud charges against Eurocopter Canada Ltd. M.B.B.’s subsidiary, Messerschmitt Canada Ltd. (MCL, now known as Eurocopter Canada), has since sold 12 helicopters to the Coast Guard.

On August 9, 2006 the Ontario Superior Court of Justice dismissed the Crown's application. The expectation is the Crown will appeal for the same reason as before.

On October 2002 two German executives – Kurt Pfeleiderer and Heinz Pluckthun – were charged with fraud. Since Germany, like many other civilized countries- contrary to Canada- will never extradite their Nationals, the IAG and the Department of Justice could have requested the German legal authorities to prosecute the German executives with no costs for the Canadian taxpayer.

*TREATY BETWEEN CANADA AND THE FEDERAL REPUBLIC OF GERMANY  
CONCERNING EXTRADITION*

*ARTICLE V*

*Extradition of Nationals*

*(3) If a request for extradition is refused only on the ground that the person claimed is a national of the requested state, that state shall, if asked to do so by the requesting state, take all possible measures in accordance with its own law to prosecute the person claimed. For this purpose, the files, documents and exhibits relating to the offence shall be transmitted to that state. All expenses incurred in connection with such prosecution shall be born by the requested state. The requesting state shall be informed of the result of the prosecution.*

Why did the Canadian Department of Justice, the IAG, the Crown, and the RCMP not ask their friends in Augsburg to prosecute the M.B.B. executives since they worked on the M.B.B. case with them and jointly examined witnesses in Germany?

In the meantime the Crown should know that they have no case and that the Germans could never charge the M.B.B. executives.

This is what Karlheinz Schreiber (who was for 9 years a Judge at the Regional Court 1 for commercial cases in Munich, Germany) told the Crown as the Crown's witness in the Court in Ottawa during his testimony. Justice Paul Belanger ruled that Karlheinz Schreiber was not a hostile witness as requested by the Crown, Mr. Bernstein.

The Crown never asked the Germans to prosecute the M.B.B. executives, because they could not take the risk that a German Court would throw out their case immediately. This would badly ruin their case in Canada and constitute proof that since 1994 Canadian taxpayers' money was blown away and invested in a lot of nice international trips for Canadian officials, hunting the phantoms of Giorgio Pelossi's and Stevie Cameron's fairy tales.

What did the Crown do regarding the M.B.B. executives? They issued arrest warrants against the two men so that they cannot leave Germany (if they do not want to end up in a jail). Is this what people around the world expect to find with Canadian principles of fundamental justice? Is this just and fair treatment to a retired man, over 70 years old, who is highly respected on the international level of the world?

Mr. Edward Greenspan, Q.C., LL.D., D.C.L. recommended: "The Canadian Government should have only International Treaties with reciprocity guarantee. The Canadian citizenship should not have a lower value than the one from other countries."

*RECIPROCITY**ARTICLE V: EXTRADITION OF NATIONALS*

*(1) Neither of the Contracting Parties shall be bound to extradite its own nationals.*

This sentence reads like an agreement on reciprocity but it is misleading the Members in the House of Commons during the ratification. The truth would have been to write "(1): Germany will never extradite its nationals to Canada. Canada may extradite its nationals to Germany."

In reality: Canada will always extradite its nationals to Germany. Canada will never prosecute its nationals in Canada on the request of Germany. Germany will prosecute its nationals on the request of Canada.

What Government would enjoy the support of its own Nationals by signing such an agreement? What Opposition in the House of Commons would not provide the strongest protest supported by the national media? Nevertheless, the Treaty was signed by the Liberal Government on October 11, 1977.

**The preliminary hearing of the M.B.B. fraud case was another fishing trip of the Crown hoping to find a crime involving Brian Mulroney and find help for their hopeless lawsuit with Karlheinz Schreiber in Edmonton.**

**The RCMP undercover operation**

2001: During the secret court proceedings of the M.B.B. Eurocopter case, RCMP Inspector A. K. Matthews revealed the nature of the undercover operation in an affidavit he swore to support the continuation of a seal on information contained in a search warrant. The warrant was part of a court proceeding involving allegations of commissions paid to Schreiber in the sale of helicopters to the Canadian Coastguard in the mid-1980s.

The undercover sting operation began in November 2000 in cooperation with a foreign agency and ended in September 2002. The agent was introduced through Michel Cogger, a former lawyer of Karlheinz Schreiber. The agent was an elegant man, who tried unsuccessfully to involve Karlheinz Schreiber in several different criminal activities and also establish confidence with him by bringing nice gifts like French champagne, Russian caviar, Italian wine and invitations to luxurious restaurants.

2004: Mr. Justice Edward Then holds a special inquiry to determine if he was misled by the RCMP and the Crown when they had him issue the sealing orders in the Eurocopter case. Justice Then has not yet issued his findings.

The aim was clear: Vahe Minasian, the agent, tried to get information regarding Brian Mulroney and Schreiber's business and at the same time to involve Mr. Schreiber in criminal activities which would put him into prison. All this would help the Crown's sick lawsuit in Edmonton and hopefully stop Karlheinz Schreiber in proceeding with his own lawsuit.

All these expensive efforts must have a very important reason. Again what have the politicians and Government officials done with the "Airbus" affair and why are they so desperate and scared?

If one looks very critically at the facts he would have to agree that this case would be a good start for the Prime Minister to clean up the pile of political mire around Ottawa for a better and politically healthier environment for Canadian citizens.

### **The German Extradition Request for Karlheinz Schreiber**

The Extradition Request comes from the same source like the "Airbus" affair: Giorgio Pelossi, Stevie Cameron, Allan Rock, other unknown political enemies. The request was prepared in Germany with the support of Canadian Government officials (IAG) International Assistance Group of the Department of Justice and the RCMP, in order to find allies and support for their vendetta against the Right Hon. Brian Mulroney and other Conservative supporters like Frank Moores, Gary Ouellet and Karlheinz Schreiber. The same group had send the Letter of Request to Switzerland.

On June 22, 1999 Professor Dr Erich Samson, Mr. Schreiber's lawyer reminded chief prosecutor Mr. Nemetz in Augsburg that the accusation for tax evasion is not an offence for extradition under the treaty between Germany and Canada. The response from Mr. Nemetz was: "We are going to get Mr. Schreiber. The Canadians have a new Extradition Act in place and behind the case is a Minister, who wants to Schreiber out of the country as soon as possible."

On August 31, 1999 Mr. Schreiber was arrested in Toronto based on an arrest warrant for tax evasion.

Since the arrest warrant did not satisfy the Canadian authorities, the prosecutor in Augsburg issued another arrest warrant on September 2, 1999 and added accusations of fraud, breach of trust and bribery.

From the 11<sup>th</sup> to the 15<sup>th</sup> of September 1999 and from the 4<sup>th</sup> to the 9<sup>th</sup> of October 1999 some Canadian lawyers from the IAG were in Augsburg and assisted the German prosecutor to prepare the record of the case for Mr. Schreiber's extradition from Canada. The document shows the date: October 11, 1999. The document was sent to the IAG and an authority to proceed was issued by IAG on behalf of the Minister of Justice of Canada.

The IAG is acting for the German prosecutors and at the same time for the Canadian Minister of Justice on Mr. Schreiber's Extradition case and until today on the pending lawsuit of Mr. Schreiber's against the Attorney General of Canada and the IAG.

Under the new Extradition Act, the IAG represents the greatest example of conflict of interest and abuse of power that one could ever imagine. They believe that they are a law unto themselves.

**The circumstances amount to a violation of the principles of fundamental justice.**

The German allies of the IAG misused the case immediately for their own political purposes and brought down the Conservative Government of Chancellor Helmut Kohl in the 1998 German election. The Social Democrats with Chancellor Gerhard Schroeder set up an Investigative Committee to shed light on the CDU affair and used this vehicle until the next German Election in 2002. They defeated the Conservative CDU/CSU again and forced the German Conservatives with Chancellor Angela Merkel after the 2005 election into a great coalition with the Social Democrats, who hope to win the next election again with the use of the Schreiber extradition case and the support from the Canadian Government.

On June 30, 2005, the last day of the legislative period of the German Bundestag, the Government of Chancellor Gerhard Schroeder (SPD) extended the statute of limitations on extradition. The new law, known in the German Parliament as the Lex Schreiber (Magazine *Spiegel* on line July 31, 2005) stipulates that the statute of limitations ceases to apply when the accused has fled abroad and extradition proceedings are under way. The prosecutors in Augsburg were afraid that the charges against Mr. Schreiber could soon be dropped because of the statute of limitations and were hoping that President Koehler will sign an amendment to the statute into law.

The law came into force on August 4, 2005 after the Deutsche Bundesrat confirmed the law on July 8, 2005.

**It is the first time in German history that a new law was used after only a few days since it was proclaimed in force, to secure the extradition of a single person accused for tax evasion.**

**The name of the person who received his own law: Karlheinz Schreiber.**



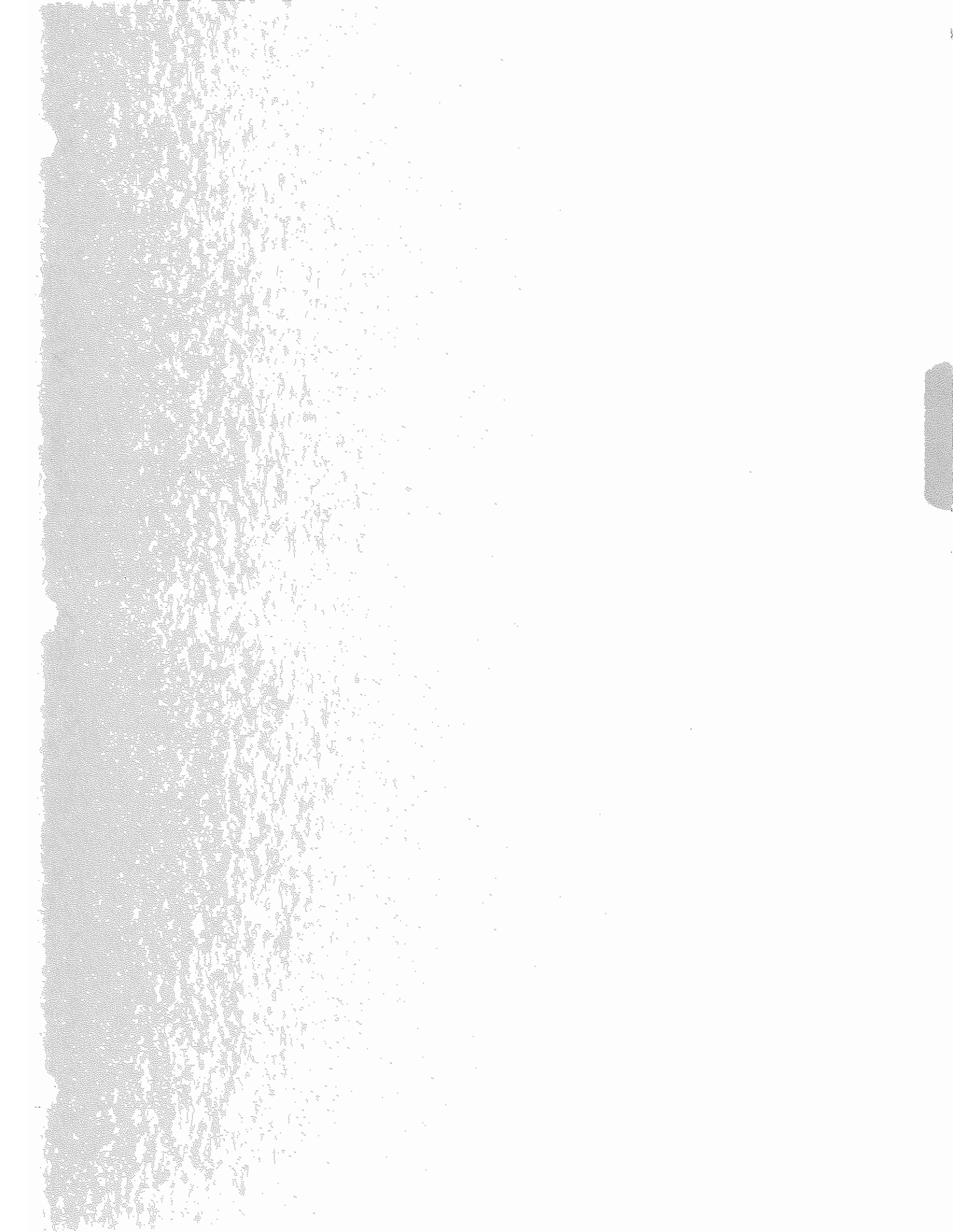

KARLHEINZ SCHREIBER

7 BITTERN COURT, ROCKCLIFFE PARK  
OTTAWA, CANADA K1L 8K9

TELEPHONE 613 748 7330  
FACSIMILE 613 748 9697  
schreiberbarbel@aol.com

The Right Hon. Brian Mulroney, P.C., LL .D.  
47 Forden Crescent

Westmount, Quebec  
H3Y 2Y5

Ottawa, October 25, 2006

Dear Brian,

I am sending you a copy of the letter to The Hon. Vic Toews for your information.

Please read this important letter very carefully. The attachments will be sent by mail.

Thank you and have a nice day.

Yours sincerely



KARLHEINZ SCHREIBER

7 BITTERN COURT, ROCKCLIFFE PARK  
OTTAWA, CANADA K1L 8K 9

TELEPHONE 613 748 7330  
TELEFAX 613 748 9697  
schreiberbarbel@aol.com

The Honourable Vic Toews, P.C., M.P.  
Minister of Justice and Attorney General of Canada

House of Commons  
Ottawa, Ontario  
K1A 0A6

Ottawa, October 25, 2006

**Subject: "Political Justice Scandal" and the "Airbus" Affair  
From Allan Rock to Irwin Cotler**

Dear Mr. Minister,

I am taking the liberty to sending you copies of the

"Political Justice Scandal" Canadian Case (Binder),  
"Political Justice Scandal" International Case (Binder),  
"Political Justice Scandal" International Case and the "Airbus" Affair, Case Report  
(attachment tab18),  
"Political Justice Scandal" International Case the "Airbus" Affair – Allan Rock &  
William Corbett (attachment tab19)  
for your personal political information.

On May 17, 2006 and on August 10, 2006 my lawyer Edward Greenspan Q.C.,  
LL. D. sent letters and submissions to you concerning the political aspects of my  
extradition case, including his submissions to the then Minister of Justice and Attorney  
General of Canada, Irwin Cotler together with the Minister's decision for surrender.

Since your decision in my case is of highly important political nature in Canada  
and Germany, I feel strongly that I have an obligation and a right to give to you my views  
of the story and the scandal. Let me tell you why:

All my life I was and I am a Conservative on an international level. The conservative Governments of the Province of Bavaria, Germany with Premier Franz Josef Strauss (Chairman of the CSU) and the conservative Government of the Province of Alberta, Canada with Premier Peter Lougheed made me come to Canada in 1974.

On September 2, 1978 I became a Canadian landed immigrant.  
On February 23, 1982 I became a Canadian Citizen.

As requested I brought jobs and substantial amounts of money to Canada. I felt very comfortable with my new Canadian conservative friends and was happy to provide support and financial help to them when required and became a member of the Conservative 500.

I don't want to drop names to impress you, but it might be that we share some friends or there are also people you may want to speak to.

The Hon. Dr. Hugh Horner's son, The Hon. Doug Horner, M.L.A.  
 The Hon. Ken Kowalski, M.L.A.  
 Rowland McFarlaness's widow Jan  
 William (Bill) Skoreyko M.P.'s widow Helen and his son Alan Skoreyko  
 The Hon. Dr. Horst A. Schmid  
 Norman Wagner professor and University president's widow Cathy  
 Rod Sykes (Major of Calgary)  
 Dr. Eric Waldmann professor  
 Robert Hladun, Q.C.  
 The Hon. Jack Major, Q.C., LL.D.  
 Lee Richardson, M.P.

The Right Hon. Brian Mulroney  
 The Hon. Don Mazankowski  
 The Hon. Elmer MacKay  
 The Hon. Frank Oberle  
 The Hon. Charles Mayer  
 The Hon. Robert Coates  
 The Hon. Frank D. Moores's widow Beth  
 The Hon. Bill McKnight  
 The Hon. Paul Dick  
 The Hon. Sinclair Stevens  
 The Hon. John M. Buchanan  
 The Hon. Don W. Cameron  
 The Hon. Peter MacKay, M. P.

The Hon. Jean Charest  
 The Hon. Benoit Bouchard  
 The Hon. Marcell Masse  
 The Hon. Monique Vezina  
 The Hon. Jean Corbeil  
 The Hon. Michel Cogger  
 Mr. Fred Doucet  
 Mr. Gerry Doucet  
 Mr. Garry Ouelett's widow Renee

Lieutenant – General J.E. Vance CMM, CD, RT and Army Major Ian Read  
 Major – General G.M. Reay, Commander MBE, CD's widow Lesley  
 Lieutenant- General J. A. Fox, Commander RT

*The older we become the more friends we loose.*

1997 LEGAL PROCEEDINGS AGAINST THE ATTORNEY GENERAL OF CANADA

Allan Rock, then the Minister of Justice and Attorney General of Canada initiated the "Airbus" affair based on talks with journalists (for all the details see the reports and the Binder Canadian Case).

On August 24, 2006 my Lawyer, Robert Hladun, Q.C. filed an appointment for Examination for Discovery concerning Allan Rock in the Court of Queen's Bench of Alberta in Edmonton.

On October 2, 2006 John H. Sims, Deputy Attorney General of Canada filed a Notice of Motion with the Court in Edmonton that he will bring an application for an order setting aside the Appointment for Examination of Allan Rock, which will start another battle all the way up to the Supreme Court of Canada. This is another chapter of the 9 year-delay tactics of the Liberal Underground Government of Canada – the Liberal bureaucracy (attachment tab 1).

**The aim is still the same: make sure that Canadians will never find out about the secrets of the "Airbus" Mulroney Vendetta and the biggest "Political Justice Scandal" in Canadian history with international political implications.**

When the legal battle begun the Attorney General was with a Liberal Government, responsible for the scandal and trying everything to stop the lawsuit.

Since February 6, 2006 the situation has changed and the Attorney General of Canada is a member of the Conservative Government, but the bureaucrats are still the same.

I will send all this material and information to you in order to bring the situation to your attention. I will ask The Right Honourable Stephen Harper M.P., Prime Minister of Canada for help to make sure that it gets to you because you are shielded by those who are the target of my legal proceedings.

CANADIAN GREAT LIARS: ALLAN ROCK, HERB GRAY, STEVIE CAMERON!

**CBC Watch, Thursday, June 3, 2004  
RCMP launched fraud investigation after hearing journalist Stevie Cameron on CBC Radio. The Cameron interview spurred police on.**

**Supt. Mathews said that two senior officers contacted her after the 1995 broadcast. They persuaded her to supply potential evidence in return for anonymity and insider information, an arrangement that recently erupted into a major legal and journalistic controversy (attachment tab 2).**

**The arrangement paid well for Steve Cameron, not for the RCMP, not for the Minister of Justice and Attorney General of Canada, not for the Solicitor General of Canada, not for the Government of Canada, not for several governments abroad, not for Canadian international reputation, not for important international industrial companies and not for Brian Mulroney, Frank Moores, Garry Ouelett and Karlheinz Schreiber.**

**Stevie Cameron provided stories with the support of Giorgio Pelossi (a convicted Swiss criminal) and helped the Mounties and other Canadian officials to find reasons to travel the world for 11 years on Canadian taxpayer's money. This started the longest RCMP criminal investigation in Canadian history. It cost millions of dollars without any result.**

**With the insider information from the RCMP Stevie Cameron (a.k.a. "Stevie Wonderful") published her second book *On the Take: Crime, Corruption and Greed in the Mulroney Years* in October 1995 DRAMATIC NEW MATERIAL ADDED and her book *The Last Amigo: Karlheinz Schreiber and the Anatomy of a Scandal* in 2001. (See the Case Report September 27, 2006 page 3.)**

**The books created public support for the RCMP and the Liberal Government concerning the political vendetta against Brian Mulroney and Karlheinz Schreiber.**

On January 6, 1997 in a Statement by Allan Rock and Herb Gray regarding the case with Brian Mulroney and the Settlement Agreement, Herb Gray, the then-Solicitor General of Canada pointed out:

*Finally, we learned three days ago that, during the investigation, there may have been a disclosure by a member of the RCMP investigative team to an unauthorized third party outside government, about who was named in the Letter of Request.*

*While the Privacy Act prevents disclosure of the names of either individual involved, I can tell you that the Commissioner has already initiated a Code of Conduct investigation and he will be available to you following this press conference to discuss the details of this process (attachment tab 3).*

Stevie Cameron writes in her book *The Last Amigo* on page 289:

*The Privacy Act notwithstanding, within hours of the press conference's conclusion, Rock's senior staff and counsel, as well as public relations specialists hired to give him advice on how to handle the affair, were telling reporters openly that the Mountie in question was Staff Sergeant Fraser Fiegenwald and the "third party" was Stevie Cameron (attachment tab 4).*

**Mike Niebudek**, President, Mounted Police Association of Ontario, reported: *Southam wanted to cover the disciplinary hearing of S/SGT. Fraser Fiegenwald, who was charged with two offenses under the Code of Conduct following the Airbus Affair. Judge Rutherford ruled that the section of the RCMP Act which allowed hearing in private was unconstitutional. Following this ruling, the RCMP decided to negotiate a deal with good old Fraser instead of carrying on with the disciplinary hearing. And I could go on....*

*Considering all these legal battles, which cost hundreds of thousands of dollars to Canadian taxpayers, maybe we should send a copy of the Constitutional Act of 1982 to the Commissioner and to the Attorney General of Canada.*

*You have to agree that it is inconceivable that the leaders of our country and of a national police force ignore this Act which takes precedence over any other legislation in our land. After all, our main mandate is to maintain the law, as says our motto. **Before insuring that the Canadian people respect the laws of our country, maybe the RCMP should set the example in its own back yard** (attachment tab 5).*

Dear Mr. Minister, do you understand what is going on with this case?

Why was Fraser Fiegenwald fired because he spoke to Stevie Cameron (the confidential RCMP informant Code A 2948) when she was entitled to insider information?

Why did Fraser Fiegenwald get a nice deal after Judge Rutherford's ruling?

Why did Herb Gray, then the Solicitor General of Canada, lie about Fraser Fiegenwald unethically speaking to Stevie Cameron when he ought to know that she was entitled to receive RCMP insider information?

Why did Allan Rock, then the Minister of Justice and Attorney General, who initiated the whole affair send people out to broadcast the untrue story on Fraser Fiegenwald and Stevie Cameron?

Why did all the individuals - from the Department of Justice, the International Assistance Group (IAG) and the RCMP - who are involved in the case, try to stop me with my lawsuit through delay, detention or extradition?

There is an explanation as long as it concerns individuals of the previous Liberal Governments, or the Canadian Underground Government - of the Liberal bureaucracy:

## PLAIN FEAR!

Imagine the truth about the biggest "Political Justice Scandal" in Canadian History with all the international implications comes to light in a Canadian court.

Imagine Canadians will learn that the "Airbus" affair was nothing more than a political vendetta against Brian Mulroney and Karlheinz Schreiber is the innocent victim.

The case of **Maher Arar** shows what can happen to an innocent victim of the RCMP and the Canadian Department of Justice.

What would happen if a Judge, like Mr. Justice Dennis O'Connor, conducted an inquiry into the "Airbus" affair and the "Political Justice Scandal"? Both affairs tortured for 11 years the families of Brian Mulroney and Karlheinz Schreiber. They damaged their reputation with confidential RCMP informant Stevie Cameron's books and their skillful manipulation of the media.



On June 5, 2006 Christine Ashcroft, a lawyer of the Department of Justice, acting for the Attorney General of Canada in the lawsuit with Karlheinz Schreiber is asking in her letter for a better Affidavit of records, regarding the business of Mr. Schreiber and payments to Brian Mulroney (attachment tab 6).

On July 31, 2006 Christine Ashcroft writes in her letter: We can advise that we object to any examination of Mr. Rock (attachment tab 7).

Since this situation is not in accordance with the announcement of the Prime Minister to clean up the Government in Ottawa, it seems to be obvious that you have no knowledge about the legal proceedings in Edmonton. I hope this information is of some help to you.

THE LIBERAL GOVERNMENT AND THE EXTRADITION  
OF  
KARLHEINZ SCHREIBER

In 1985, I became the Chairman of Thyssen – Bearhead Industries and came to Ottawa on the request of the Canadian Government and The Right Hon. Prime Minister Brian Mulroney to create jobs in the Province of Nova Scotia and to bring success to the USA–Canadian Defense Production Sharing Agreement.

For eight years I worked on the project. I learned, through bitter experience, that the Liberal bureaucracy in Ottawa with Paul Tellier, Bob Fowler and the support of Joe Clark undermined the policies of the Government of Brian Mulroney everywhere. What I did find were lies, frauds, conspiracy, greed, ignorance, arrogance, disappointment and great sadness for Canada and Canadians. The failure to use the superior military products developed by Thyssen – Bearhead (especially their armoured personnel carriers) cost the lives of Canadian soldiers and for what. The only gain was to achieve the Liberal Underground Government's goal to frustrate the policies of the legitimately-elected Conservative government of Canada.

Thyssen, the Canadian soldiers, the people of Nova Scotia, Quebec and I have been misused and betrayed after Thyssen spent more than \$60 Million on the project for peacekeeping and environment – protection.

In other words, it was easy for me to make enemies with the second Canadian Government (the Liberal bureaucracy).

**If Canadians will ever get to know what really happened they will be shocked from coast to coast. I am still in contact with the witnesses including four Generals of the Canadian Armed Forces and several Ministers of previous Canadian Governments.**

Having this situation in mind it is easy to understand why my enemies in the spring of 1995 teamed up with the German prosecutors, Stevie Cameron the RCMP informant and Giorgio Pelossi, the Swiss convicted criminal (see the Case Report).

On April 1, 1998 R. Brettschneider, RCMP Liaison Officer at the Canadian Embassy in Bonn, Germany send a letter to the German authorities and wrote: "Canadian investigators are equally interested in having Schreiber arrested. You will be contacted immediately in the event of any information which would assist you."

Why and on what legal basis did the RCMP want Schreiber arrested? There was never a charge or an arrest warrant issued against Mr. Schreiber (the document is in the International Case binder tab 5).

From the 11<sup>th</sup> to the 15<sup>th</sup> of September 1999 and from the 4<sup>th</sup> to the 9<sup>th</sup> of October 1999 some lawyers of the Canadian Department of Justice (IAG) were in Augsburg, Germany and assisted the German prosecutors to prepare the record of the case for Mr. Schreiber's extradition from Canada (read the whole story in the Case Report). The cooperation is still working.

My lawsuit against the Liberal Attorney General of Canada is the only legal route besides a public inquiry to bring the "Political Justice Scandal" in a Canadian court to light. This is why my enemies try everything to stop my actions. Their greatest wish is to have me extradited to Germany, hoping that I will disclose matters of interest to them during a trial in court and at the same time bring the lawsuit to an end in Edmonton. (Read all the details in the Case Report, in the report on Allan Rock & William Corbett and in the binder of the Canadian Case and the International Case of the "Political Justice Scandal".)

#### IRWIN COTLER'S LIBERAL RESCUE ACTION

When The Hon. Irwin Cotler, then the Minister of Justice and Attorney General of Canada, signed the warrants ordering Mr. Schreiber's surrender to the Federal Republic of Germany on October 31, 2004 he wrote to my Lawyer Edward Greenspan Q.C., LL.D

#### VI. Conclusion

It is my opinion that none of the circumstances which you raise, either individually or cumulatively, lead to a finding that Mr. Schreiber's surrender to Germany would be "shocking or fundamentally unacceptable to our society", or that his circumstances are such that they "constitutionally vitiate an order of surrender". I have also determined that there are no other considerations that would justify ignoring Canada's obligations under the Treaty between Canada and Germany Concerning Extradition.

On page 13 of the same letter Mr. Cotler wrote: My decision on surrender is a political one which involves balancing the interests of the person sought with Canada's international obligation.

With his conclusion and decision he presents the evidence that he is either fully integrated in the cover up of the "Political Justice Scandal" initiated by Allan Rock, Stevie Cameron RCMP informant, Herb Gray and other Liberal companions or he was totally under the control of the IAG and ignorant.

It looks to me that Mr. Cotler ascribed to the same credo, as do all the other people who are involved in the "Airbus" vendetta and the "Political Justice Scandal": maintain at all costs the principle of the "Constant Lie"

*There is no Canadian obligation to extradite its Nationals to Germany.*

*Mr. Cotler knows that Germany will never extradite one of its Nationals to Canada. The German Constitution, Article 16 (2) will not allow the extradition of its Nationals.*

#### ARTICLE V OF THE TREATY : EXTRADITION OF NATIONALS

(1) *NEITHER OF THE CONTRACTING PARTIES SHALL BE BOUND TO EXTRADITE ITS OWN NATIONALS.*

The truth is: The TREATY BETWEEN CANADA AND THE FEDERAL REPUBLIC OF GERMANY CONCERNING EXTRADITION applies only to individuals, who are not German Nationals.

Canada has 49 not 50 Bilateral Extradition Treaties (attachment tab 8). 15 of the Treaties entered into force during the last Centuries. 22 countries, with the highest standards of civilization and culture do not extradite their Nationals. 21 countries have reserved the rights to decide on the extradition of their Nationals. Only 7 countries extradite their Nationals. See the Treaties and the publication of the RCMP, Interpol, the Canadian Central Authority and the IAG (attachment tab 9).

**I reviewed every single Extradition Treaty which is on the list and found another huge lie: imagine the government of Canada signed 42 out of 49 Extradition Treaties without reciprocity, which is the most elementary common basis of each Treaty, and the misled members of the Canadian House of Commons ratified the Treaties (Treaty attachments tabs 15 – Germany, 16 – Finland, 17 – Korea as examples).**

RCMP Interpol Ottawa published an Interpol History Report (attachment tab10).  
On page 3 you will read: Assistance to the Canadian Law Community and Interpol  
Member Countries - point 5:

**CANADA EXTRADITES ITS NATIONALS**

Dear Minister, people from around the world followed the invitation of the Canadian government and came to Canada like myself and helped to grow the country. I saw quite a few of them with tears in their eyes at the day, when they became Canadian Citizens. Don't you think that all of them expected to receive a Canadian Citizenship with quality standards other civilized countries provide for their Nationals?

**I have never seen a Government advertising the extradition of its Nationals.  
I wonder what you may think when you read this.**

On May 5, 1995 the Department of Justice announced:  
EXTRADITION REFORMS TABLED. The signature of Kimberly Prost (IAG) was on the document.

On June 17, 1999 the Department of Justice announced:  
NEW EXTRADITION ACT COMES INTO FORCE. The signature of William Corbett (IAG) was on the document. (See the report attached "Political Justice Scandal" International Case).

The new Extradition Act reduced the jurisdiction of the Extradition Judge and increased substantially the Jurisdiction of the Minister of Justice and Attorney General.

In my case the Extradition Judge had to believe in the statements made by a German prosecutor and ignore the rulings of Liechtenstein Courts, the decisions of Liechtenstein Investigative Judges and prosecutors, the sworn affidavit of a lawyer (a previous Swiss prosecutor); the decision of the Minister of Justice in Switzerland who refused to grant legal assistance related to my case and the only statement from the so called Crown witness Giorgio Pelossi even given under oath in the Court of Augsburg: "None of the Liechtenstein companies mentioned in the accusations was incorporated for the purpose of tax evasion."

Irwin Cotler then the Minister of Justice and Attorney General of Canada had the duty to examine my case and to make a personal decision.

RCMP Interpol I - The Canadian Central Authority publication page 14:

**"While the Minister relies upon advice from the IAG, he or she decides each case personally."**

The Minister relies upon advice from the IAG, the officials who drafted and sent the Letter of Request to Switzerland, who are responsible for the "Political Justice Scandal," the "Airbus" affair and my lawsuit against the Attorney General of Canada.

The RCMP and the IAG officials conspire with the German prosecutors to cover up the huge problems they have with the threat of disclosure and exposure through my legal proceedings in Edmonton, knowing that they lost the lawsuit at the moment when the RCMP finally closed the files on the Brian Mulroney "Airbus" vendetta.

Let me show to you a perfect example: On Mai 17, 2006 and on August 10, 2006 my Lawyer Edward Greenspan, Q.C. sent letters to you concerning the political prejudgment of the German authorities in my case. There is no law or extradition request or charges for the introduction of political corruption in Germany. The statements of Judge Haeusler brought the truth about the political reasons of my case to light.

On March 9, 2006 the following article was available on the Deutsche Presse – Agentur website (DPA is one of the world's leading international news agencies supplying news on a global basis):

*Schreiber Requests that Supreme Court of Canada Refuse Extradition.*

In that article the following comments were made:

...Judge Karl Heinz Haeusler, spokesman for the Regional Court of Augsburg, told dpa that after his extradition, Schreiber would have to reckon with the "full force of the law". **"He is the trigger of the entire affair and has caused damage to Germany."**

**...Until the Schreiber case, Germany had been considered a country immune to bribery [he stated] – the arms dealer's "unconcealed exertion of influence" on politicians and managers made the "unspeakable" reality. Schreiber had done Germany a "disservice", said the Court spokesman...**

(Mr. Greenspan's letters, attachments tabs 11 and 13).

The IAG officials know that the German authorities ruined my extradition case by themselves and therefore it is in their own interest to try to rescue it.

On July 28, 2006 Barbara Kothe, Senior Counsel, International Assistance Group sent a memorandum to you regarding the case; which speaks for it-self (attachment 12).

On October 14, 2004 Jacqueline Palumbo, Counsel, International Assistance Group, Barbara Kothe, A/Director, International Assistance Group and William Corbett, Senior General Counsel, Criminal Law Section sent a memorandum to Irwin Cotler, then the Minister of Justice and Attorney General for Canada.

The memorandum was the basic document for the Minister's decision to surrender Mr. Schreiber. The memorandum speaks for itself (see the report "Political Justice Scandal" International Case, The "Airbus" Affair – Allan Rock & William Corbett).

The IAG, the Department of Justice and the office of the Attorney General of Canada seek to delay the legal proceedings for many more years. Their aim is to help the Liberals to cover the Brian Mulroney "Airbus" affair and the biggest "Political Justice Scandal" in Canadian history with great international political implications (see the Case Report and the "Political Justice Scandal" binders attached).

The continuation of the already lost lawsuit will just increase the amount of the already wasted Canadian taxpayer's money under your responsibility, you inherited from Allan Rock and Irwin Cotler.

How will you ever get to know what is going on if you have to rely on the advice of the IAG who are the enemies of the Canadian Conservatives in this case since 1995?

How is the continuation of this case in accord with the Conservative's federal election promise to Canadian voters to clean up government in Ottawa?

I am an expert on the tactics of the Liberal Underground Government and the often-used arguments to prevent the ministers responsible to do the right thing:

*Mr. Minister, don't do this, the matter is before the court (and there it will be dragged along for the next five to ten years). Who cares about the citizens involved and the tax payer's money?*

*Mr. Minister, don't do this, the matter is a RCMP investigation, which we cannot jeopardize. They know what they are doing. They are our friends. Who cares when they travel for ten years to Germany, Liechtenstein, Switzerland, Italy, France, United Kingdom, United States and Mexico enjoying life in nice hotels on the account of Canadian taxpayers' money as long as they hunt Brian Mulroney and Karlheinz Schreiber and keep the Conservatives busy?*

*Mr. Minister, don't do this, we had already calls from the Ottawa Citizen, the CBC Fifth Estate Harvey Cashore and Stevie Cameron, you better get prepared for question hour today and tomorrow.*

Dear Minister, I am certain that you have heard similar stories many times since you began your career in politics.

None of the stories applies to my case, because you have nothing to hide, you can only be interested in the clean up in the "Airbus" affair and the "Political Justice Scandal".

You are the central authority; you have the jurisdiction for the final political decision concerning my extradition.

You are the responsible Attorney General of Canada, representing the government in my legal proceedings against the previous Attorney General of Canada.

**Dear Minister, all the decisions on the cases have to be made by you and nobody else. The Canadian Courts play no role concerning the political decisions. Only you have the jurisdictions and the responsibilities related to these cases.**

On January 20, 1997 I sent a letter to Allan Rock, then the Minister of Justice and Attorney General of Canada and responded to his Letter of Apology to me.

I wrote:

**I recognize your apology but this matter will only be properly clarified in a court room**  
(attachment tab 14).

**Today, nine years and nine months later, I take the liberty to ask you respectfully for your support and help by reviewing my case and let me bring to light to Canadians the biggest "Political Justice Scandal" in Canadian history and to bring to an end the nightmare of this case for my family and me.**

The new Extradition Act grants you the jurisdiction and the political mandate to inform the Supreme Court of Canada about your review of my case and ask the Supreme Court of Canada to put the extradition request on hold.

I believe that my request is in accordance with the Prime Minister Stephen Harper's announcement to clean up the Government in Ottawa and the need for a Director of Public Prosecutions when he referred to the Mulroney – Airbus affair.

The history of Canada proves that the Conservative governments were always interim solutions. The Liberals governed Canada most of the time. This is the success of the Liberal bureaucracy, the underground Government of Canada, which brought down the Conservative government of The Right Honourable Brian Mulroney from 211 seats in 1984 to two seats in 1993.

Dear Minister, please stop the support from the Department of Justice and the IAG in favor of the Liberal Underground Government concerning the "Airbus" Vendetta.

There is no Conservative future in Canada without a real clean up!

Yours sincerely

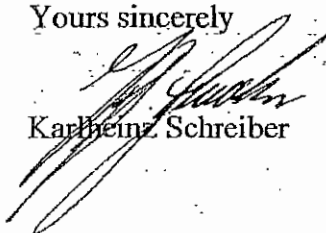

Karlheinz Schreiber

Copy to The Right Honourable Stephen J. Harper, P.C., M.P.  
Prime Minister

Canada

Canada

Edmonton Office  
Prairie Region  
211 Bank of Montreal Bldg  
10199 - 101 Street  
Edmonton, Alberta  
T5J 3Y4

Bureau d'Edmonton  
Région des Prairies  
Bâtiment de la Banque de Montréal  
211 rue 101 - 10199  
Edmonton, Alberta  
T5J 3Y4

Telephone: (780) 495-6051  
Facsimile: (780) 495-6300

Internet: oashcrof@justice.gc.ca

Our File: 2-77605  
Notre dossier:

Your File:  
Votre dossier:

June 5, 2006

**BY FAX**

Hladun & Company  
Barristers and Solicitors  
100, 10187 - 104 Street  
EDMONTON, Alberta  
T5J 0Z9

Attention: Robert W. Hladun  
Fax # 424-0934

Dear Sir:

**RE: Schreiber v. The Attorney General of Canada**

I am assisting Jim Shaw with this file.

I understand that you have asked us to produce our documents.

We have reviewed Mr. Schreiber's Amended Amended Statement of Claim, and the Affidavit of Records. If this action is to proceed, our view is that Mr. Schreiber will need to file a further and better Affidavit of Records.

Below, we speak of the Statement of Claim, but in each case are referring to the Amended Amended Statement of Claim.

Referring to para. 12 of the Statement of Claim, we understand that Mr. Schreiber received some sort of notification of the Swiss authorities' request for banking records from the Swiss Union Bank. Mr. Schreiber should disclose the documents related to the notification in his Affidavit.

As you know, Mr. Schreiber is responsible to produce documents which are or were in his custody and control, which includes documents of companies which he owns or controls, or has owned or controlled. We understand that Mr. Schreiber conducted his business through several companies. Mr. Schreiber will need to produce any relevant and material documentation from these companies. Such documents would include, but not be limited to, records of contracts or understandings in principle between Mr. Schreiber's companies and such companies as MBB, Thyssen Industrie AG, Altrus Industrie, and Bear Head Manufacturing Industries BMI Inc.

This is Exhibit "A" referred to in the  
Affidavit of  
Joanne Romans  
Sworn before me this 13<sup>th</sup> day  
of July A.D., 2006  
Tania Norris  
A-Nelson-Burke, A Commissioner for Oaths  
in and for the Province of Alberta  
**TANIA NORRIS**  
Commissioner of Oaths  
My Commission Expires  
May 30, 2008

Canada



- 2 -

Documents held by Mr. Schreiber's lawyers or ex-lawyers remain within Mr. Schreiber's possession or control, and therefore Mr. Schreiber should produce non-privileged documents relevant to this matter which are in the possession of Mr. Schreiber's lawyers or ex-lawyers, including Peter Widmer.

Referring to para. 12 of the Statement of Claim, Mr. Schreiber should have banking records which relate to this matter. Such documents would include banking records from Verwaltungs-Und Private Bank in Vaduz, Liechtenstein. Banking records of companies controlled by Mr. Schreiber which relate to the allegations in the Statements of Claim and Defence are also relevant to this matter.

The documents would also include bank documents showing payments from MBB, Thyssen, Airbus Industrie, and Bear Head Manufacturing to IAL or other companies controlled by Mr. Schreiber, and payments from companies controlled by Mr. Schreiber to persons such as Mr. Moores and Mr. Schreiber, or companies such as Consultants International Incorporated.

You have said in discoveries that the ownership of IAL was by bearer certificate. Mr. Schreiber should be able to produce the bearer certificate or advise when it left his possession. There should be other relevant IAL documents. Even if some of them are no longer in Mr. Schreiber's possession or control, they should be listed in the Affidavit.

Referring to para. 14 and 15 of the Statement of Claim, Mr. Schreiber should have a copy of the letter of apology, and his own letter to the Deputy Attorney General and the Commissioner of the RCMP, and any letter he received in response. If he has other correspondence related to his alleged efforts to obtain apologies or revisions to Crown documents, that documentation should be produced.

Referring to para. 20 of the Statement of Claim, we understand that Mr. Schreiber says that he did pay some money to Brian Mulroney. He should produce documentation related to those payments.

Referring to para. 20 of the Statement of Claim Mr. Schreiber states there was no criminal activity as set out in the Letter of Request, or at all. He has denied criminal activity. He has put all of his business dealings into issue. He has also made many public statements, or responded in books and interviews. Mr. Schreiber must inform himself of all of that and disclose all documents relating to the matter which are relevant and material to this lawsuit.

At para. 30 of the Statement of Claim, the Plaintiff alleges that he has lost economic opportunity and income. He must have documentation in relation to that claim, and he will need to produce it.

At para. 19 of the Amended Statement of Defence, we allege that Mr. Schreiber provided Mr. Mulroney with a copy of the German version of the Letter of Request. If Mr. Schreiber has or had a copy of the German version, it should be set out in his Affidavit.

- 3 -

In *Germany v Schreiber*, before Mr. Justice Watt, there is reference to Mr. Schreiber's personal organizer. Documentation from the organizer which is material to this lawsuit must be produced.

Further, your client has been involved in many lawsuits related to this matter. All documentation which he or his counsel has received in these lawsuits is now within his possession or control, and must be produced in this matter. For example, Mr. Schreiber sued CBC, and should have documents produced during that lawsuit for disclosure, as well as documentation of his own related to that lawsuit which is also relevant and material to this lawsuit.

Some time has elapsed since 2003. Your client will likely have new relevant and material documentation in his possession, which should be added to his production.

Of course, we are unable to know exactly what relevant and material documents your client has in his possession or control. Clearly, however, his present Affidavit of Records is deficient.

We know you will review Mr. Schreiber's responsibilities respecting document production with him, to ensure compliance with his legal obligation to locate, gather, and produce all documents material and relevant to this matter. No doubt there are more material and relevant documents beyond what we have requested in this letter.

We look forward to receiving your filed further and better Affidavit of Records.

Yours truly,



Christine Ashcroft  
Counsel

jr



Department of Justice  
Canada

Ministère de la Justice  
Canada



Edmonton Regional Office  
211 Bank of Montreal Bldg  
10199 - 101 Street  
Edmonton, Alberta  
T5J 3Y4

Bureau régional d'Edmonton  
Edifice de la Banque de Montréal  
211 rue 101 - 10199  
Edmonton, Alberta  
T5J 3Y4

Telephone: (780) 495-6051  
Facsimile: (780) 495-6300

Internet: [christine.sabroft@justice.gc.ca](mailto:christine.sabroft@justice.gc.ca)

Our File: 2-90141  
Notre dossier:

Your File: 45890.1  
Votre dossier:

July 31, 2006

**BY FAX**

Hladun & Company  
Barristers and Solicitors  
100, 10187 - 104 Street  
EDMONTON, Alberta  
T5J 0Z9

Attention: Robert W. Hladun  
Fax # 424-0934

Dear Sir:

**RE: Schreiber v. The Attorney General of Canada**

Thank you for your letter requesting discovery of Mr. Allan Rock. We can advise that we object to any examination of Mr. Rock.

At common law, the Crown is not compellable at discovery. It is only through legislation that it may be compelled to discovery. Section 7 of the Regulations passed pursuant to the *Crown Liability and Proceedings Act* states that an officer or servant of the Crown may be designated for examination for discovery. The Court of Appeal has interpreted this section to mean that except for the right to examine a Crown designated officer, there is no machinery for examination for discovery as of right. See *CDIC v Prisco*, (1997) 206 A.R. 283 (C.A.)

This decision was followed in *Milne and Milne v AG of Canada et al.*

Quite apart from the foregoing, there is case law regarding when a Minister may be examined. There must be special circumstances, and there must be no other person who is equally well-informed.

Canada

In any event, we will object to the examination of any person other than the Crown officer.

Yours truly,

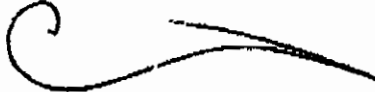

**CHRISTINE A. ASHCROFT**  
Counsel  
Civil Litigation and Advisory Services

CAA/jr

**Karlheinz Schreiber**

86916 Kaufering Raiffeisenstrasse 27 Telefon (08191) 7884 Telefax (08191) 7888

January 20, 1997

Honourable Allan Rock  
Minister of Justice &  
Attorney General of Canada

- and to -

Phillip Murray  
Commissioner, RCMP

Dear Sirs:

This letter is written as an open letter to yourselves and to the Canadian public as a response to your letter of apology sent in care of my lawyer, Mr. Robert W. Hladun, Q.C. on January 9, 1997. A number of things were mentioned in that letter besides the apology and accordingly, it has become necessary for me to respond to that letter. I will address each point as it appears in your letter of January 9, 1997, a copy of which is attached for your convenience. Addressing each point in order as follows:

1. I wish to express my satisfaction with the settlement you have reached with the Right Honourable Brian Mulroney. I can only state that this is a settlement that should have been reached much earlier and an apology which should have been given from the outset.
2. It is no news to me that the Government of Canada sought assistance from Switzerland. I was told that I was not being accused of any crime. However, I was implicated in the circumstances described in the Letter of Request from the moment the Canadian Government demanded access to accounts of mine all over Switzerland, also all of those accounts over which I may have had a proxy. On the direction of the Canadian government, the Swiss authorities caused a search and seizure of all of my banking papers and documents, whatsoever.

3. Whether or not it is reasonable for the Canadian Government to believe that the request for assistance was a highly confidential state-to-state communication remains to be seen. It is utter nonsense to state that the Swiss would understand that this Request for Assistance contained only allegations that were to be verified given the wording of the Request for Assistance. The Request for Assistance reads like a summary of facts and includes such statements as "this investigation is of serious concern to the Government of Canada as it involves criminal activity on the part of the former Prime Minister." In fact, if you look at the entire Letter of Request and the statements that are set out therein as facts, one must question how the Swiss are to understand these as being merely allegations, and "that the persons named were presumed innocent of any wrongdoing." In fact, nowhere in the Request for Assistance is it explicitly stated that the people named therein are presumed innocent and that these are only allegations. Indeed, the Letter of Request reads like a criminal indictment.
4. I can easily imagine that requests for assistance have been sent to Switzerland before which have remained confidential. However, I have the feeling that you did not grasp the difference between a request for assistance or information and a request for search and seizure which is what happened in my case. The average Canadian would have difficulty understanding that search and seizure is to remain confidential when the Letter and its contents are given by the police force in Switzerland to all sorts of bank employees from the board of directors down to the tellers at the counter.
5. The Canadian Government asked the Swiss to search and seize every account all over Switzerland which I owned or over which I had a proxy. The Swiss refused to do so and instead asked for copies of my banking documents. This has had a great impact on my reputation when you consider I have maintained a house in Switzerland and conducted banking there over the past twenty years.

If you ask to search offices, homes or apartments in Switzerland, invariably investigators will show up in four or five cars, they will look everywhere and will put everything of interest in boxes and transport them to their offices. Do you still expect something like this to remain confidential? This is akin to expecting that a request for the arrest and extradition of an individual in a foreign country will remain confidential.

6. Given the revelations regarding Sergeant Fiegenwald in media reports, this last paragraph is somewhat ridiculous. The tone and content of this paragraph only tells me and the Canadian public that the Government of Canada is totally unprofessional in formulating requests for assistance. A search and seizure or arrest can in and of itself never stay confidential. On the other hand, requested countries respect their law which requires them to disclose requests for search and seizure to the suspects. Since there is a dramatic difference between confidentially asking for information and a search and seizure, all civilized

countries are required to provide a search warrant from a proper court. I can provide you copies of Mutual Legal Assistance Treaties of all members of the European Community which show that search warrants are required.

It is readily apparent to me that the officials of the Canadian Government did not honour the *Treaty for Mutual Legal Assistance* entered into between Canada and Switzerland which was signed on October 7, 1993. It requires the Canadian Court to issue a declaration that such a measure would be permissible if the subject matter of the search and seizure were located in Canada prior to it being executed upon by the foreign country. As Justice Wetston ruled on July 4, 1996, the Canadian Government would not have been able to carry out a similar search and seizure on Canadian soil. Further, it is of interest that the *Treaty* was ratified in Canada on November 17, 1995 and the Letter of Request was sent in "just under the wire" on September 29, 1995. The only person competent to issue a search warrant is a judge or someone acting judicially. However, if it is your position that a competent authority is a police force acting on its own, then that reminds me of the nightmare years of my childhood when the Nazi regime set loose the Gestapo on the German public.

7. I also take great pleasure in learning today that it is recognized that I am "presumed innocent" as required by law under the *Charter* but for over the past year you have permitted the Letter of Request to stand where it names me as a criminal and sets out in great detail the criminal indictment as to the crime that I was implicated in. The person with whom I am to have perpetrated the crime is the former Prime Minister, Brian Mulroney. It is interesting that as of January 6, 1997, the Government of Canada says that there is no evidence to say that he was involved in criminal activity and you apologize to me for having reached a conclusion that I was involved in the criminal activity but you insist that there is still an ongoing criminal investigation. This begs the question - What criminal activity?

The Request for Assistance states that I was involved in the crime of bribing the former Prime Minister. You now say that - "No, you are not involved in that. For saying that you were, we apologize. However, we will still investigate." It is unclear to me, and I am sure the Canadian public feels the same, what it is that you are investigating. The whole foundation upon which the Request for Assistance is built has collapsed with the apology to the former Prime Minister.

I would not wish the enormous pain, suffering and embarrassment that you have caused for my friends and family on anyone. You have acted deliberately and recklessly in sending out the Letter of Request without foundation, and today, sixteen months later, you feel the need to apologize.

8. With respect to this paragraph, I would merely point out that this was not only the RCMP that had a hand in this letter but your own Department of Justice as well

and accordingly can be accused of reaching the same conclusions that the RCMP did.

9. I recognize your apology but this matter will only be properly clarified in a court room. This is my understanding. I have been a judge for commercial matters for nine years in Munich. Perhaps, I have a different understanding of law and order than you do.

Since the letter you sent me appeared in the media, this letter is provided to the media in order to give the Canadian public my side of the story.

Yours truly,



KARL HEINZ SCHREIBER



# **“Political Justice Scandal” International Case And the “Airbus” Affair**

## **Case Report**

Ottawa, September 27, 2006

The case began as the “Airbus” affair. It turned quickly to become the biggest “Political Justice Scandal” in Canadian history with the most serious international implications.

The initiators of the scandal are: The Department of Justice of Canada including The Hon. Allan Rock, then the Minister of Justice and Attorney General of Canada, William Corbett Q.C. Senior General Counsel, Kimberly Prost, then the Director, International Assistance Group. The Hon. Herb Gray, then the Solicitor General of Canada, the RCMP, Stevie Cameron the confidential RCMP informant (RCMP Code A2948) and complainant and the convicted Swiss criminal Giorgio Pelossi.

The vendetta against The Right Hon. Brian Mulroney and the Canadian Conservatives started after Allan Rock met with reporter Mary Janigan on November 2, 1993 and he was having dinner with the Globe and Mail reporter Susan Delacourt on November 18, 1993. He became Minister of Justice and Attorney General on November 4, 1993.

On June 14, 1996, The Right Hon. Stephen Harper, Prime Minister, then M.P (Calgary West, Ref) during Commons Debates:

*Mr. Speaker, that kind of hair-splitting could only be done by a lawyer. I am citing an article in the Toronto Sun yesterday where it says that Globe and Mail managing editor Colin MacKenzie said that Rock approached parliamentary journalist Susan Delacourt for help in his behind the scenes probe of Mulroney one or two days after he first heard about allegations from an other journalist. My question is very simple. Going back to the beginning of this affair, why was the Minister of Justice conducting his own private investigation?*

When Stevie Cameron’s book *On the Take* hit the best-seller lists in 1994, Liberals in Ottawa took to calling Cameron “Stevie Wonderful”. When Solicitor Herb Gray read it, he made sure that the RCMP was reviewing it carefully, to see if any investigation was warranted.

(An article from Saturday Night, October 1, 1996: *Vicious Circle – Media's Role in the Airbus Scandal Involving Brian Mulroney* is important to read.)

A letter from the Augsburg City Tax Office (Germany) to the office of the Public Prosecutor on August 02, 1995 confirmed that the RCMP through the Canadian Embassy in Germany was, since May 24, 1995, in contact with the Senior Prosecutor Kolb and informed the authorities in Augsburg about their apparent investigation in Switzerland.

On July 24, 1995 the Augsburg tax investigators met with Giorgio Pelossi in Bregenz, Austria, to receive information on I. A. L. business. Because of the risk to be arrested Pelossi did not come to Augsburg.

On August 24, 1995 RCMP Inspector McLean, Liaison Officer Canadian Embassy Bern, Switzerland, writes to Kimberly Prost, Department of Justice, how to draft the Letter of Request to Switzerland to alleviate any problem *vis a vis* RCMP contact with a witness.

On September 6, 1995 G. Pelossi informed the tax investigators in Augsburg that Sergeant Fraser Fiegenwald and Inspector Yves Bouchard are the RCMP officers investigating in Switzerland. On September 11, 1995 the two officers met with the prosecutors in Augsburg and agreed to compare notes. (Read Cameron, *The Last Amigo*, page 260 about the illegal contact with a witness in Switzerland)

Kimberly Prost and the International Assistance Group (IAG) fabricated the Letter of Request to the Competent Legal Authority of Switzerland based on the stories from Giorgio Pelossi, without any real evidence but a lot of lies.

## Giorgio Pelossi

On December 12, 1995 RCMP Inspector Gene McLean, acting as Liaison Officer at the Canadian Embassy in Bern, Switzerland informed the authorities in Ottawa that Giorgio Pelossi had a criminal record, being convicted on June 6, 1995 for a false accusation. Pelossi was sentenced on December 24, 1996 to three month detention, suspended for a two year period for embezzlement, specifically for wrongfully investing money for his own profit between 1984 and 1986.

On September 11, 1986 Pelossi was arrested by Swiss Police and detained for six month without charge. He was suspected of swindling money from a bank account belonging to someone laundering drug money for the Mafia. The prosecutor was Carla del Ponte, now Chief UN War Crimes Prosecutor. On January 22, 2000 Pelossi was arrested and detained by the police in Chicago in connection with Italian drug-trafficking charges.

The presiding Judge Maximilian Hofmeister together with 4 other judges and some prosecutors from the Augsburg Regional Court were traveling several times to Zuerich, Switzerland to examine Giorgio Pelossi. Pelossi cannot leave Switzerland because of the Italian arrest warrant against him. Switzerland will not extradite its Nationals

## Stevie Cameron (RCMP CODE A 2948)

October 1994 Stevie Cameron, Confidential RCMP Informant code A2948, complainant, journalist and writer published her book: *On the Take: Crime, Corruption and Greed in the Mulroney Years*.

During the Eurocopter preliminary hearing an RCMP investigator described Cameron as a key source of information. Supt. Mathews said that two senior officers contacted her after the 1995 broadcast. They persuaded her to supply potential evidence in return for anonymity and insider information, an arrangement that recently erupted into a major legal and journalistic controversy.

In her speech at the University of Saskatchewan in February 1995 she said with respect to the allegations that Frank Moores had profited on the Airbus sale: "I talked to the Mounties about this last week in Ottawa".

As respected columnist and former NDP Member of Parliament Doug Fisher pointed out, Cameron's Saskatchewan speech created the almost irresistible inference that "Cameron and the RCMP have both joint interests and a joint association".

In 2001 Steve Cameron published with the help of Harvey Cashore (producer at the fifth estate, a CBC TV program) her book: *The Last Amigo: Karlheinz Schreiber and the Anatomy of a Scandal*. The book was an orgy of lies and an exercise in mental masturbation. These books postulate that a solid base for a fraud case exists to anybody who believes Ms. Cameron's assertion that her books tell the truth.

The Crown advises the Court that informer will consent to waive privilege "for the prosecution of Brian Mulroney".

The joint interest of Cameron and the RCMP comes to light. The exchange of information helps the RCMP concerning their ill fated investigation and allows Stevie Cameron to produce income from books, her main interest besides recognition.

The book *The Last Amigo* is The Confession of Incompetence

The Credo of Ignorance

The Creed of Envy

## MBB AND THYSSEN

Based on the information from Giorgio Pelossi and the Canadian officials, the Augsburg prosecutors were granted warrants to search the offices of MBB, Messerschmitt – Boelkow – Blohm on August 2, 1995 the offices of Thyssen – Industrie on August 14, 1995 and the offices of Bayerische Bitumen Chemie on July 25, 1995.

### Bayerische Bitumen Chemie

On October 5, 1995 German police raided the company and the home of Karlheinz Schreiber, in Kaufering, Germany and seized documents. The raid was in connection with an investigation into suspected tax invasion.

The search of the offices of MBB, Bayerische Bitumen Chemie and Thyssen - Industrie disclosed unrelated matters to the accusations, which finally led to the "CDU Donation Scandal" in Germany and involved the governments of France, Saudi Arabia, Thailand, Costa Rica, Mexico, Austria, Switzerland, Liechtenstein, USA and Canada.

### The Letter of Request to Switzerland

On September 29, 1995 William Corbett Q.C. Senior General Counsel of the Department of Justice authorized Kimberly Prost, Director International Assistance Group (IAG), Department of Justice Canada to send the Letter of Request for Legal Assistance to Switzerland.

Insp. McLean, RCMP Liaison Officer at the Canadian Embassy, presented the Letter of Request concerning Brian Mulroney, Frank Moores, Garry Ouellet and Karlheinz Schreiber to the appropriate authorities in Switzerland.

On October 26, 1995 Swiss officials seized the bank accounts and safety deposit boxes of Frank Moores and Karlheinz Schreiber.

## International Cooperation

On April 30, 1996, Stevie Cameron, confidential RCMP informant, complainant, journalist and writer met with Senior Public Prosecutor Hillinger and Prosecutor Weigand in Augsburg, Germany. During the meeting Stevie Cameron provided documents regarding Canadian Companies of the suspect Mr. Karlheinz Schreiber, a copy of a newspaper article: *Arms and the Woman* and a copy of her book *On the Take*, which all has been placed on the file. Around the same time she met for some days with Giorgio Pelossi, the Swiss convicted criminal.

At the same month, Canadian tax officials were beginning to work together with their German counterparts. Stevie Cameron, the confidential RCMP informant reports in *The Last Amigos* at p. 285: On June 4, 1996 two Revenue Canada officers, Bruce Findlay and Guy Bigonnesse, met in Augsburg with the tax investigators Gumpendobler, Kindler and others to share intelligence. They swapped binders of confidential tax information.

## The Legal Battle

On November 20, 1995 the Right Hon. Brian Mulroney filed a \$50 million lawsuit against the Canadian Government and the RCMP.

On January 9, 1997 the Government of Canada, The Hon Allan Rock, then Minister of Justice and Attorney General of Canada and Philip Murray, then Commissioner, of the RCMP have sent a letter of apology to Karlheinz Schreiber and informed him about the settlement agreement of January 5, 1997 with the Right Hon. Brian Mulroney.

Karlheinz Schreiber thought at that time- and thinks that he is proven right today- that it was a mistake to settle the lawsuit. He also believed at that time and feels the same way today that the statement by The Hon. Allan Rock and The Hon. Herb Gray, regarding the case of the *Right Hon. Brian Mulroney v. The Attorney General of Canada* on Monday, January 6, 1997 is a totally unacceptable insult and a historical lie in its dimension.

This political vendetta has cost the Canadian taxpayer millions of dollars so far and will cost much more because the case has not come to an end after 11 years and is still moving ahead, driven by the enormous fear of the individuals, responsible for the biggest "Political Justice Scandal" in Canadian history.

On January 20, 1997 Karlheinz Schreiber sent a letter to the Hon. Allan Rock, then Minister of Justice and Attorney General of Canada and to Phillip Murray, then Commissioner of the RCMP.

In his letter Karlheinz Schreiber explains, why the Minister's letter is pure nonsense and full of lies. The last paragraph no. 9 of his letter: "I recognize your apology but this matter will only be properly clarified in a courtroom. This is my understanding .I have been a judge for Commercial Law for nine years in the Court of Munich."

On January 30, 1997 Schreiber's lawyer Robert Hladun Q C., Edmonton, sent a letter to Hon .Allan Rock and Philip Murray, RCMP. Page 6 of the letter reads:

*We have learned that the Swiss government still labours under the impressions created by the original Request, together with all the accusations and indictment therein that now have been shown or proven to be erroneous, false and untrue.*

*In the event that the Government of Canada fails to recognize the above and officially withdraw / revoke the said Request, it is the intention of Mr. Karlheinz Schreiber to seek the appropriate legal remedy before the appropriate legal forum to resolve all of those issues that have arisen since the issuance of the said Request.*

*Therefore, we respectfully request an immediate reply not later than seven days from the date of this letter.*

**Neither Mr. Hladun Q. C. nor Mr. Schreiber received an answer to their letters.**

On October 24, 1997 Mr. Schreiber filed a \$35 million lawsuit against the Canadian Government.

Since the Right Hon. Brian Mulroney entered a settlement agreement with the Canadian Government, Mr. Schreiber's lawsuit is the only legal avenue, which would shed light to the unbelievable political vendetta and the biggest "Political Justice Scandal" in Canadian history.

At the same time Mr. Schreiber's lawsuit is the greatest threat to all the responsible politicians and government officials, who were or are still involved in the case. Canadians from coast to coast will be shocked and scared when the truth of the case will come to light and when it will be known what all was done by the Department of Justice to avoid the truth to be seen.

The alternative to the Schreiber lawsuit would have been a publicly commissioned inquiry as unsuccessfully requested by several M.P.'s in the House of Commons.

On December 3, 1997 Mr. Jack Ramsay M. P. (Crowfoot, Ref.) made a motion to the Standing Committee on Justice and Human Rights.

The questions he raised are still unanswered and very interesting to read. The documents in the case book contain also very important statements regarding the Brian Mulroney and Karlheinz Schreiber cases from:

Mr. Stephen Harper M.P. (Calgary West, Ref)  
Messr. Gilles Duceppe M.P. (Laurier-Sainte-Marie, B.Q.)  
Mr. Peter MacKay M.P. (Pictou-Antigonish-Guysborough, P.C.)  
Mr Garry Breitkreuz M.P. (Yorkton-Melville, Ref.)  
Messr. Michel Bellehumeur M.P. (Bertier-Montcalm, B.Q.)  
Mr. Kevin Sorenson (Crowfoot, Canadian Alliance)

**Mr. Breitkreuz stated: "The confidence of Canadians in their institutions and the justice system is at stake."**

**Today, 8 years and 7 months later Canadians still do not know what happened and what is still ongoing with the case.**

## **Attempt to stop the Lawsuit**

To avoid the disclosure of the "Political Justice Scandal" through the Schreiber lawsuit, the Justice Department and the R.C.M.P. have chosen different defence measures for their face-saving action.

1. Delay actions since 1997 regarding the lawsuit proceedings in Edmonton.
2. The MBB fraud case.
3. RCMP undercover operation.
4. The German Extradition Request for Karlheinz Schreiber

**All of these activities raise one question: What have they done and try to hide under all circumstances? Why have these people acted at all costs to suppress the truth?**

**Mr. Schreiber is convinced that his lawyers will make sure that the secrets of the biggest "Political Justice Scandal" in Canadian history will come to light.**

**The lawyers dealing with this task are:**

**Mr. Edward L. Greenspan Q.C., LL.D., D.C.L.**  
**The Hon. Jack Major, Q.C., LL.D.**  
**Mr. Robert W. Hladun, Q.C.**

### **1 Delay actions regarding the lawsuit**

Since 1997 the Department of Justice has tried to delay the proceedings of the lawsuit by requesting more and more documents from Mr. Schreiber regarding business matters clearly irrelevant and not at issue. The requests are part of permanent "fishing expeditions," related to the Right Hon. Brian Mulroney. It looks like the Department of Justice wants to start a new investigation in a file the RCMP closed in April 17, 2003.

The Department of Justice failed to provide better affidavits of documents and undertakings from discovery examinations and refused to send documents to their own lawyers in Edmonton. The aim is clearly to keep the lawsuit away from the court because there is no chance to win the case, since the RCMP closed the file on the fact that there was no evidence of wrongdoing.

**The main reason to keep the case away from a public trial in the courts is the fear of disclosure and personal consequences.**

### **2 The MBB fraud case**

The MBB fraud case is the only thing that was left from the accusations in the Letter of Request to Switzerland on September 29, 1995, starting the "Airbus" affair, which is the legal basis for the lawsuit.

The Attorney General of Canada, the International Assistance Group (IAG) of the Canadian Department of Justice and the R.C.M.P., who fabricated the Letter of Request need the insane MBB fraud case to claim that there is an ongoing investigation to avoid any access to information.

For the same reason the Crown appealed the ruling of Mr. Justice Paul Belanger of the Ontario Court of Justice, who has thrown out fraud charges against Eurocopter Canada Ltd. MBB's subsidiary, Messerschmitt Canada Ltd. (MCL, now known as Eurocopter Canada).

On August 9, 2006 the Ontario Superior Court of Justice dismissed the Crown's application. The Crown did not appeal the judgment. The "Airbus" affair came to an end.

On October 2002 two German executives – Kurt Pfeleiderer and Heinz Pluckthun – were charged with fraud. Since Germany, like many other civilized countries- contrary to Canada- will never extradite their Nationals, the IAG and the Department of Justice could have requested the German legal authorities to prosecute the German executives with no costs for the Canadian taxpayer, as per the treaty excerpted below:



*TREATY BETWEEN CANADA AND THE FEDERAL REPUBLIC OF GERMANY  
CONCERNING EXTRADITION*

*ARTICLE V*

*Extradition of Nationals*

*(3) If a request for extradition is refused only on the ground that the person claimed is a national of the requested state, that state shall, if asked to do so by the requesting state, take all possible measures in accordance with its own law to prosecute the person claimed. For this purpose, the files, documents and exhibits relating to the offence shall be transmitted to that state. All expenses incurred in connection with such prosecution shall be born by the requested state. The requesting state shall be informed of the result of the prosecution.*

Why did the Canadian Department of Justice, the IAG, the Crown, and the RCMP not ask their friends in Augsburg to prosecute the MBB executives since they worked on the MBB case with them and jointly examined witnesses in Germany?

The Crown should have known that they have no case and that the Germans could never charge the MBB executives.

This is what Karlheinz Schreiber (who was for 9 years a Judge at the Regional Court 1 for commercial cases in Munich, Germany) told the Crown as the Crown's witness in the Court in Ottawa during his testimony. Justice Paul Belanger ruled that Karlheinz Schreiber was not a hostile witness as requested by the Crown, Mr. Bernstein.

The Crown never asked the Germans to prosecute the MBB executives, because they could not take the risk that a German Court would throw out their case immediately. This would badly ruin their case in Canada and constitute proof that since 1994 Canadian taxpayers' money was blown away and invested in a lot of nice international trips for Canadian officials, hunting the phantoms of Giorgio Pelossi's and Stevie Cameron's fairy tales.

What did the Crown do regarding the MBB executives? They issued arrest warrants against the two men so that they cannot leave Germany (if they do not want to end up in a jail). Is this what people around the world expect to find with Canadian principles of fundamental justice? Is this just and fair treatment to a retired man, over 70 years old, who is highly respected on the international level of the world?

Mr. Edward Greenspan, Q.C., LL.D., D.C.L. recommended: "The Canadian Government should have only International Treaties with reciprocity guarantee. The Canadian citizenship should not have a lower value than the one from other countries."

*RECIPROCITY**ARTICLE V: EXTRADITION OF NATIONALS*

*(1) Neither of the Contracting Parties shall be bound to extradite its own nationals.*

This sentence reads like an agreement on reciprocity but it is misleading. The truth would have been to write "(1): Germany will never extradite its nationals to Canada. Canada may extradite its nationals to Germany."

In reality: Canada will always extradite its nationals to Germany. Canada will never prosecute its nationals in Canada on the request of Germany. Germany will prosecute its nationals on the request of Canada.

What government would enjoy the support of its own Nationals by signing such an agreement? What Opposition in the House of Commons would not provide the strongest protest supported by the national media? Nevertheless, the Treaty was signed by the Liberal Government on October 11, 1977.

**The preliminary hearing of the MBB fraud case was another fishing trip of the Crown hoping to find a crime involving Brian Mulroney and find help for their hopeless lawsuit with Karlheinz Schreiber in Edmonton.**

### **3 The RCMP undercover operation**

2001: During the secret court proceedings of the MBB Eurocopter case, R.C.M.P. Inspector A. K. Matthews revealed the nature of the undercover operation in an affidavit he swore to support the continuation of a seal on information contained in a search warrant. The warrant was part of a court proceeding involving allegations of commissions paid to Schreiber in the sale of helicopters to the Canadian Coastguard in the mid-1980s.

The undercover sting operation began in November 2000 in cooperation with a foreign agency and ended in September 2002. The agent was introduced through Michel Cogger, a former lawyer of Karlheinz Schreiber. The agent was an elegant man, who tried unsuccessfully to involve Karlheinz Schreiber in several different criminal activities and also establish confidence with him by bringing nice gifts like French champagne, Russian caviar, Italian wine and invitations to luxurious restaurants.

2004: Mr. Justice Edward Then holds a special inquiry to determine if he was misled by the RCMP and the Crown when they had him issue the sealing orders in the Eurocopter case. Justice Then has not yet issued his findings.

The aim was clear: Vahe Minasian, the agent, tried to get information regarding Brian Mulroney and Schreiber's business and at the same time to involve Mr. Schreiber in criminal activities which would put him into prison. All this would help the Crown's sick lawsuit in Edmonton and hopefully stop Karlheinz Schreiber to proceed with his lawsuit.

All these expensive efforts must have a very important reason. Again what have the politicians and government officials done with the "Airbus" affair and why are they so desperate and scared?

If one looks very critically at the facts he would have to agree that this case would be a good start for the Prime Minister to clean up the pile of political mire around Ottawa for a better and politically healthier environment for Canadian citizens

#### **4 The German Extradition Request for Karlheinz Schreiber**

The Extradition Request comes from the same source like the "Airbus" affair: Giorgio Pelossi, Stevie Cameron, Allan Rock, other unknown political enemies. The request was prepared in Germany with the support of Canadian government officials (IAG) International Assistance Group of the Department of Justice and the R.C.M.P., in order to find allies and support for their vendetta against the Right Hon. Brian Mulroney and other Conservative supporters like Frank Moores, Gary Ouellet and Karlheinz Schreiber. The same group had send the Letter of Request to Switzerland.

On June 22, 1999 Professor Dr Erich Samson, Mr. Schreiber's lawyer reminded chief prosecutor Mr. Nemetz in Augsburg that the accusation for tax evasion is not an offence for extradition under the treaty between Germany and Canada. The response from Mr. Nemetz was: "We are going to get Mr. Schreiber. The Canadians have a new Extradition Act in place and behind the case is a Minister, who wants Schreiber out of the country as soon as possible."

On August 31, 1999 Mr. Schreiber was arrested in Toronto based on an arrest warrant for tax evasion.

Since the arrest warrant did not satisfy the Canadian authorities, the prosecutor in Augsburg issued another arrest warrant on September 2, 1999 and added accusations of fraud, breach of trust and bribery.

From the 11<sup>th</sup> to the 15<sup>th</sup> of September 1999 and from the 4<sup>th</sup> to the 9<sup>th</sup> of October 1999 some Canadian lawyers from the IAG were in Augsburg and assisted the German prosecutor to prepare the record of the case for Mr. Schreiber's extradition from Canada. The document shows the date: October 11, 1999. The document was sent to the IAG and an authority to proceed was issued by IAG on behalf of the Minister of Justice of Canada.

The IAG is acting for the German prosecutors and at the same time for the Canadian Minister of Justice on Mr. Schreiber's Extradition case and until today on the pending lawsuit of Mr. Schreiber's against the Attorney General of Canada and the IAG.

Under the new Extradition Act, the IAG represents the greatest example of conflict of interest and abuse of power that one could ever imagine. They believe that they are a law unto themselves.

**The circumstances amount to a violation of the principles of fundamental justice.**

The German allies of the IAG misused the case immediately for their own political purposes and brought down the Conservative government of Chancellor Helmut Kohl in the 1998 German election. The Social Democrats with Chancellor Gerhard Schroeder set up an Investigative Committee to shed light on the CDU affair and used this vehicle until the next German Election in 2002. They defeated the Conservative CDU/CSU again and forced the German Conservatives with Chancellor Angela Merkel after the 2005 election into a great coalition with the Social Democrats, who hope to win the next election again with the use of the Schreiber extradition case and the support from the Canadian Government.

On June 30, 2005, the last day of the legislative period of the German Bundestag, the government of Chancellor Gerhard Schroeder (SPD) extended the statute of limitations on extradition. The new law, known in the German Parliament as the *Lex Schreiber* (Magazine *Spiegel* on line July 31, 2005) stipulates that the statute of limitations ceases to apply when the accused has fled abroad and extradition proceedings are under way. The prosecutors in Augsburg were afraid that the charges against Mr. Schreiber could soon be dropped because of the statute of limitations and were hoping that President Koehler will sign an amendment to the statute into law.

The law came into force on August 4, 2005 after the Deutsche Bundesrat confirmed the law on July 8, 2005.

**It is the first time in German history that a new law was used after only a few days since it was proclaimed in force, to secure the extradition of a single person accused for tax evasion.**

**The name of the person who received his own law: Karlheinz Schreiber.**

On March 9, 2006, the following article was available on the *Deutsche Presse-Agentur* website (DPA is one of the world's leading international news agencies supplying news on a global basis): *Schreiber Requests that the Supreme Court of Canada Refuse Extradition.*

In that article, the following comments were made:

*...Judge Karl-Heinz Haeusler, spokesman for the Regional Court of Augsburg, told DPA after his extradition, Schreiber would have to reckon with the "full force of the law". "He is the trigger of the entire affair and has caused damage to Germany."*

*...Until the Schreiber case, Germany has been considered a country immune to bribery [he stated]-the arms dealer's "unconcealed exertion of influence" on politicians and managers made the "unspeakable reality". Schreiber had done Germany a "disservice", said the court spokesman...*

The statement of the judge shows the real reason for the extradition request from Germany. It has nothing to do with criminal activities; it is a pure political statement and nonsense.

**The truth is: The German politicians want me to be extradited from Canada to Germany for political reasons and hope to win the next election again with the support of my case.**

**The truth is: The Canadian politicians and government officials involved in the case want me to be extradited to Germany to avoid the biggest "Political Justice Scandal" in Canadian history with substantial international implications and personal consequences.**

The players that were responsible for the "Political Justice Scandal" are the individuals who stage-managed it and those who failed to discharge their political responsibilities by remaining silent or tolerating what went on in Canada and abroad.

The initiators: Hon. Allan Rock, Stevie Cameron, Georgio Pelossi, CBC The Fifth Estate.

Responsible yet silent: The Right Hon. Jean Chretien, The Right Hon. Paul Martin, Hon. Anne McLellan, Hon. Martin Cauchon, Hon. Irwin Cotler.

Dereliction of duty: Solicitors General: Hon. Herb Gray, Hon. Andy Scott, Hon. Lawrence MacAulay, Hon. Wayne Easter, Hon. Anne McLellan.

The Henchmen: R.C.M.P. Commissioners J.P.R.Murray and Giuliano Zaccardelli.

**Karlheinz Schreiber**

# **“Political Justice Scandal” International Case**

## **The “Airbus” Affair – Allan Rock & William Corbett**

On November 2, 1993 Reporter Mary Janigan met with Allan Rock.

**At this time Allan Rock conducted a private investigation into Brian Mulroney’s affairs.**

On November 4, 1993 Allan Rock became Minister of Justice until June 10, 1997.

On November 18, 1993 now the Honorable Minister of Justice and Attorney General of Canada dined with journalist Susan Delacourt and asked her whether she had heard anything about offshore accounts and Progressive Conservative wrongdoing. No, she replied, all she knew was that Stevie Cameron was writing a book and may know something. Rock then “mused” about asking the RCMP to look into various allegations, including questions about the source of the mortgage payments on Mulroney’s Westmount home.\*

**(On June 14, 1996 during ORAL QUESTION PERIOD in the House of Commons Mr. Stephen Harper, Calgary West, Ref. had a question for the Minister of Justice related to the “AIRBUS” affair. My question is very simple: “Going back to the beginning of this affair, why was the Minister conducting his own private investigation?”). This question remains unanswered until today.**

On December 2, 1993 Allan Rock sent a letter to Herb Gray, the Solicitor General, who was responsible for the operations of the RCMP. Rock wrote: “I would like to report to you on a matter that has been brought to my attention. On November 2, 1993, Mary Janigan gave me certain information about the contracting practices of the government in office 1984-1993 that, if true, suggests serious wrongdoing and possible criminal offences. Similarly, on November 18, 1993 Susan Delacourt indicated to me that she had information on the same subject. \*

**With the letter Allan Rock initiated the Vendetta against Brian Mulroney and the biggest “Political Justice Scandal” in Canadian history.**

Corp.

On September 29, 1995 Kimberly Prost, Senior Counsel Director International Assistance Group (IAG) Department of Justice Canada has send the Letter of Request for Assistance from Canada to Switzerland in the matter of Brian Mulroney, Frank Moores, Garry Ouellet and Karlheinz Schreiber.

Fraser Fiegenwald and other officers from the RCMP together with Kimberley Prost and other officials of the IAG drafted the Letter of Request to Switzerland based on the stories from Giorgio Pelossi and Stevie Cameron, knowing that they had no real evidence at all.

**(Fraser Fiegenwald confirmed the facts under oath during Examinations for Discovery with respect to the Schreiber lawsuit against the Attorney General of Canada in Edmonton AB on March 8, 2006 and in his testimony during the Preliminary Hearing in the Eurocopter legal proceedings.)**

Obviously, it was not an ordinary request involving a former Prime Minister and for that reason Kimberley Prost sought guidance from her immediate supervisor William H. Corbett, Senior General Counsel, (criminal law). Corbett gave the go-ahead to the Letter of Request. He saw no need to consult his superior Daniel Bellemare, the assistant Deputy Attorney General (criminal law), or George Thomson, Deputy Minister of Justice. \*

Kimberly Prost confirmed the facts under oath during Examinations for Discovery with respect to the Schreiber lawsuit against the Attorney General of Canada in Toronto on May 9, 2000.

**William H. Corbett started with his decision regarding the Letter of Request the biggest "Political Justice Scandal" in Canadian history with the most serious international implications. For himself he earned the full responsibility for the letter which forced the Liberal Government of Canada into a Settlement Agreement with Brian Mulroney and letters of apologies from Allan Rock, Minister of Justice and Attorney General and Philip Murray, Commissioner, RCMP to Frank Moores and Karlheinz Schreiber.**

The financial consequences for the Canadian Taxpayers are that millions of dollars have been already spent with no foreseeable ending.

The most important question remains unanswered: How could it happen that an experienced lawyer and Senior General Counsel of the Canadian Department of Justice could allow such an unprofessional letter, damaging to Canada's international reputation, to be sent to Switzerland?

(\*William Kaplan: Presumed Guilty)



Corp

**William Corbett was involved in the proceedings in different courts related to the Letter of Request dated September 29, 1995.**

**On October 24, 1997 Karlheinz Schreiber filed \$ 35 Million law suit against the Attorney General and the Canadian Government.**

### **William H. Corbett - Affidavit**

**In the Federal Court of Canada, Trial Division, between Karlheinz Schreiber (Applicant) and the Attorney General of Canada (Respondent)**

**I, William H. Corbett, Q.C., Barrister and Solicitor, of 284 Wellington Street, in the City of Ottawa, Province of Ontario, MAKE OATH AND SAY AS FOLLOWS:**

- 1. That I am a member in good standing of the Law Society of Upper Canada.**
- 2. That I have knowledge of these proceedings, and of the earlier proceedings in this Court, in the Federal Court of Appeal, and in the Supreme Court of Canada, relating to a Letter of Request dated September 29, 1995.**
- 3. That I am employed by the Department of Justice, Government of Canada, and presently occupy the position of Senior General Counsel, Criminal Law Branch, at the Departmental Headquarters in Ottawa. I have occupied this position since 1988, and report directly to the Assistant Deputy Attorney General (Criminal Law). I have personal knowledge of the matters herein set out, except where such knowledge is specifically said to be on information and belief, and where so stated I verily believe the information to be true unless the contrary is asserted .**
- 4 That as Senior General Counsel, and Manager within the Criminal Law Branch I have managerial responsibilities for the Mutual Legal Assistance work of the Department of Justice. I have been involved in this work since 1982.**
- 5. That the Departmental file relating to the aforesaid Letter of Request is one over which I have managerial control.**

**These are 5 out of 9 paragraphs from the Affidavit sworn before a Notary Public in and for the Province of Ontario, Mr. Lamont on November 5, 1998.**

**On March 8, 1999 Cross - Examination of William Corbett Q.C. (IAG) was held in Ottawa in relation with legal proceedings in the Federal Court of Canada between Karlheinz Schreiber and the Attorney General of Canada, regarding the Letter of Request to Switzerland.**

Corp

**William H. Corbett Q. C.****Affidavit and Transcript from Cross-Examination**

On March 13, 1997 William H. Corbett stated under oath in an affidavit:  
*That as Senior General Counsel and Manager within the Criminal Law Branch I have managerial responsibilities for Mutual Legal Assistance work of the Department of Justice. I have been involved in this work since 1982 (affidavit attached).*

On March 8, 1999 William H. Corbett stated under oath during cross-examination:

*25. Q: What else does your job entail?*

*A: I have a similar supervisory responsibility for the Ottawa-Hull Prosecution's Group, which is responsible for all federal prosecutions in Eastern Ontario, Eastern and Northern Ontario, more particularly, Ottawa-Hull.*

*The group also has a network of agents throughout Eastern and Northern Ontario.*

*It is like a Prosecution Group in regional Office, if you are familiar with Edmonton- I have forgotten what there are now, 15 or 16 prosecutors in that unit. That unit is responsible to me as well, through a Director, if you will, or a Group Head.*

*We also have four other lawyers, plus myself, who deal with Supreme Court of Canada litigation all federal criminal litigation comes through this office on its way to the Supreme Court of Canada. (Transcript of the Cross-Examination attached.)*

Corp.

On October 14, 2004 a Memorandum was sent to Irwin Cotler, then Minister of Justice and Attorney General of Canada, providing background information on the extradition case involving Mr. Karlheinz Schreiber. The Memorandum was signed by Jacqueline Palumbo, Counsel International Assistance Group (IAG) and William H. Corbett Q.C. Senior General Counsel, Criminal Law Section (Page 1 and 65 attached)

As a matter of fact I was confronted with Allan Rock then Attorney General, Herb Gray then Solicitor General, Philip Murray then Commissioner RCMP, Mrs. Stevie Cameron, RCMP Confidential Informant and complainant, Mrs. Kimberley Prost then Director of the International Assistance Group (IAG).

Always and everywhere I faced the confrontation with Mr. William Corbett Q.C., Senior General Counsel, Criminal Law Branch, at Departmental Headquarters in Ottawa and the International Assistance Group (IAG).

1. With the Letter of Request in Switzerland
2. With the Letter of Request in Canada
3. At the Court of Queen's Bench of Alberta in Edmonton
4. At the Federal Court of Canada
5. At the Supreme Court of Canada in Ottawa
6. At the Superior Court of Ontario in Toronto (Representing Germany)
7. At the Court of Appeal for Ontario in Toronto (Representing Germany)
8. At the Ontario Court of Justice in Ottawa
9. With the Minister of Justice of Canada in Ottawa (Representing Germany)
10. With the Prosecutors in Augsburg (Representing Canada and Germany)

Corp.

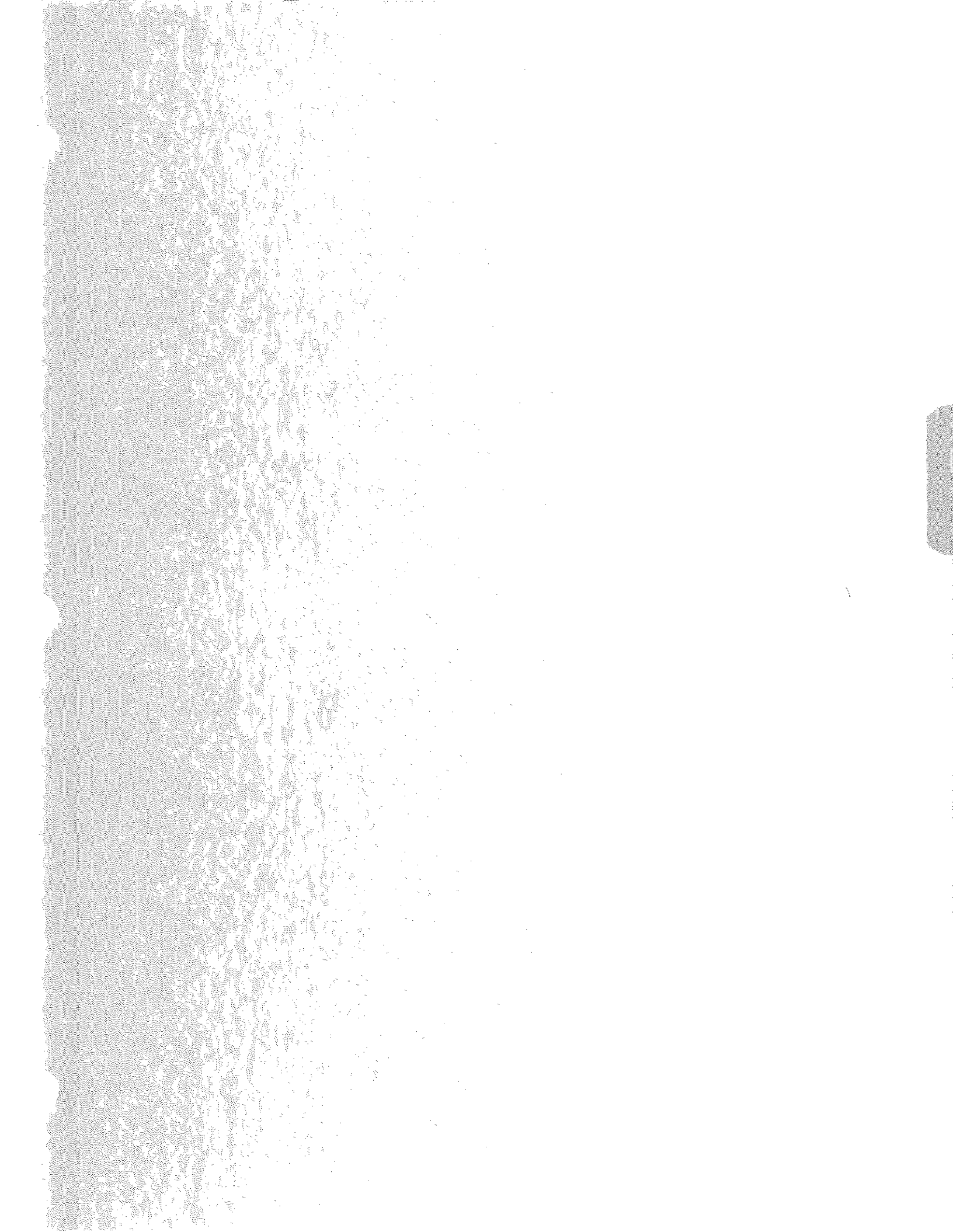



KARLHEINZ SCHREIBER

7 BITTERN COURT, ROCKCLIFFE PARK  
OTTAWA, CANADA K1L 8K9

TELEPHONE 613 748 7330  
TELEFAX 613 748 9697  
schreiberbarbel@aol.com

The Right Hon. Brian Mulroney, P.C., LL .D.  
47 Forden Crescent

Westmount, Quebec  
H3Y 2Y5

Ottawa, November 30, 2006

Via fax 1 514 369 9393

Dear Brian,

I am sending you a copy of my letter November 30, 2006 to The Right Hon. Stephen Harper with attachments concerning the IAG of the Department of Justice and The Hon. Stockwell Day, Minister of Public Safety concerning a letter November 15, 2006 from the Commission for Public Complaints Against the RCMP.

I am also sending a copy of a letter November 15, 2006 from Robert Hladun, Q.C. to The Hon. Vic Toews, Minister of Justice and Attorney General of Canada for your personal information.

Yours sincerely

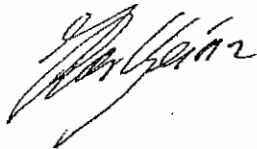

KARLHEINZ SCHREIBER

63 17 13 19

7 BITTERN COURT, ROCKCLIFFE PARK  
OTTAWA, CANADA K1L 8K9

TELEPHONE 613 748 7330  
TELEFAX 613 748 9697  
schreiberbarbel@aol.com

Personal / For His Eyes Only

The Right Hon. Stephen Joseph Harper P.C., M.P.  
Prime Minister

House of Commons  
Ottawa, Ontario  
K1A 0A6

Ottawa November 30, 2006

**Subject: "Political Justice Scandal"**

Dear Prime Minister,

I am taking the liberty to send you the copies of two facsimile November 14<sup>th</sup> and 16<sup>th</sup> from the IAG for your personal information.

The documents speak for themselves and may give you some evidence concerning the IAG and the "Political Justice Scandal". I am referring to my letter October 27, 2006 I have sent to you.

The attached copy of my letter to the Hon. Stockwell Day is also for your personal information.

Yours sincerely



Karlheinz Schreiber

 Department of Justice / Ministère de la Justice  
 Canada / Canada

## FACSIMILE TRANSMISSION

SEND TO		FROM	
<b>Name:</b>	Karlheinz Schreiber	<b>Name:</b>	Julie Fitton for Jacqueline Palumbo  Counsel
<b>Address:</b>	7 Bittern Court Rockliffe Park Ottawa, Ontario K1L 8K9		International Assistance Group Federal Prosecution Service East Memorial Building, Room 2291 284 Wellington Street Ottawa, Ontario K1A 0H8
<b>Fax #:</b>	<b>Tel. #:</b>	<b>Fax #:</b>	<b>Tel. #:</b>
613-748-9697		613-957-8412	613-957-3489
<b>Comments:</b>			
RE: <u>FEDERAL REPUBLIC OF GERMANY V. KARLHEINZ SCHREIBER</u>  Please refer to attached correspondence.  Thank you.			
<b>SECURITY INSTRUCTIONS</b>			
Unclassified documents only VIA clear transmission. Protected information permitted within Justice secure FAX network.			
Protected documents?		<input checked="" type="checkbox"/> Yes	<input type="checkbox"/> No
<b>Transmission</b>			
<b>Pages (+1):</b>	<b>Date:</b>	<b>Time</b>	
5	November 16, 2006	3:18 PM	



Department of Justice  
Canada

Ministère de la Justice  
Canada

International Assistance Group  
Federal Prosecution Service  
284 Wellington Street, EMB-2291  
Ottawa, Ontario  
K1A 0H8

Telephone: 613-957-3489  
Facsimile: 613-957-8412

November 16, 2006

**BY FACSIMILE: 613-748-9697**

Karlheinz Schreiber  
7 Bittern Court  
Rockcliffe Park  
Ottawa, ON K1H 8K9

Dear Mr. Schreiber:

**Re: Karlheinz SCHREIBER**  
**- Extradition request from the Federal Republic of Germany**  
**- Second Supplemental Summary of Case and Submissions on Reconsideration**

I am attaching a copy of the second supplemental summary prepared for the Minister in relation to your request for reconsideration of the previous Justice Minister's decision on the issue of surrender. This summary contains an outline of your submissions contained in your letter dated October 25, 2006 and your three binders of attachments.

Please note that your submissions and attachments, in their entirety, will be put before the Minister of Justice for his consideration, together with the attached summary.

Yours sincerely,

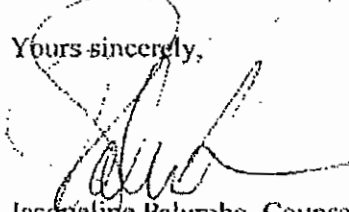

Jacqueline Palumbo, Counsel  
International Assistance Group  
Federal Prosecution Service

c.c. Edward Greenspan, Q.C., Greenspan, White (fax: 416-366-7994)



Department of Justice / Ministère de la Justice  
Canada

Room 2287, 284 Wellington Street  
Ottawa, Ontario

MEMORANDUM / NOTE DE SERVICE

Security classification - Côte de sécurité
File number - Numéro de dossier
Date November 16, 2006
Telephone / FAX - Téléphone / Télécopieur 613-957-3489 / 613-957-8412

TO / DEST: Minister

FROM / ORIG: Jacqueline Palumbo, Counsel, International Assistance Group  
(via Janet Henchey, General Counsel and Associate Director,  
International Assistance Group)

SUBJECT / OBJET: **GERMANY v. Karlheinz SCHREIBER**  
- Extradition from Canada to Germany  
- Second Supplemental Summary of Case and Submissions on  
Reconsideration

Comments/Remarques

**I. PURPOSE OF THIS MEMORANDUM**

This memorandum provides you with a summary of additional submissions sent directly to you by Mr. Karlheinz Schreiber in support of his petition that you reconsider your predecessor's decision to surrender him to Germany. His further submissions are contained in a letter dated October 25, 2006, together with three binders of attachments. All of these materials are appended in their entirety to this memorandum.<sup>1</sup>

Please note that by letter dated November 15, 2006, counsel for Mr. Schreiber advised the International Assistance Group that Mr. Schreiber's additional submissions do not form part of the request for reconsideration submitted on Mr. Schreiber's behalf by his counsel on May 17 and August 10, 2006.<sup>2</sup>

**II. SUMMARY OF SUBMISSIONS**

In his letter to you dated October 25, 2006, Mr. Schreiber writes:

<sup>1</sup> Appendix A: Submissions from Mr. K. Schreiber dated October 25, 2006, including three binders of attachments.

<sup>2</sup> Appendix B: Letter dated November 15, 2006 from Mr. Edward Greenspan to Jacqueline Palumbo, International Assistance Group.

Do not write in this space / Ne pas écrire dans cet espace

- 2 -

*Since your decision in my case is of a highly important political nature in Canada and Germany, I feel strongly that I have an obligation and a right to give to you my views of the story and the scandal.*

He submits that he has been the victim of "the biggest 'Political Justice Scandal' in Canadian history with international political implications". He blames the former Liberal governments and the so-called "Liberal bureaucracy" (which he also describes as "the Liberal Underground Government of Canada") for this "scandal" and, further, he submits that one of the ways in which they have perpetuated this scandal is by delaying and thwarting Mr. Schreiber's outstanding lawsuit against the former Attorney General of Canada, Mr. Allan Rock, in the Alberta Queen's Bench. In this regard, he writes:

*My lawsuit against the Liberal Attorney General of Canada is the only legal route besides a public inquiry to bring the "Political Justice Scandal" in a Canadian court to light. This is why my enemies try everything to stop my actions. Their greatest wish is to have me extradited to Germany, hoping that I will disclose matters of interest to them during a trial in court and at the same time bring the lawsuit to an end in Edmonton.*

Mr. Schreiber underscores the following actions, amongst others, as supporting his allegation of a "political vendetta" carried out against himself and Brian Mulroney by the former Liberal governments and the so-called "Liberal Underground Government of Canada":

1. During the "Airbus affair", two "senior officers" persuaded author Stevie Cameron to give evidence of alleged fraud against Mr. Schreiber in return for "anonymity and insider information" which she then used in her books attacking Mr. Schreiber. He states that these books "*created public support for the RCMP and the Liberal government concerning the political vendetta...*";
2. Millions of taxpayer dollars have been spent in support of an RCMP investigation against Mr. Schreiber that has resulted in no charges;
3. Persons named in the confidential Letter of Request to Switzerland were allegedly disclosed by an RCMP officer to Stevie Cameron who published this insider information in her books. The RCMP officer was later the subject of an RCMP disciplinary hearing;
4. The RCMP struck a deal with the RCMP officer who allegedly disclosed the confidential information to Ms. Cameron and this transaction occurred after the Superior Court of Justice ruled that the RCMP's disciplinary hearings

- 3 -

were unconstitutional insofar as they were held in private. In this regard, Mr. Schreiber is suggesting that the RCMP entered into the said arrangement in order to avoid a public hearing of the matter;

5. Then Solicitor General Herb Gray and then Minister of Justice Allan Rock made alleged misrepresentations to the public regarding the unauthorized disclosure of the names of persons who were the subjects of Canada's Letter of Request to Switzerland;
6. In April 1998, the RCMP advised the German authorities that Canada was also interested in arresting Mr. Schreiber but they had no legal grounds on which to charge him;
7. In September and October of 1999, officials with the International Assistance Group attended in Germany to assist the German prosecutors in preparing their Record of the Case in support of their extradition request.

In particular, Mr. Schreiber targets the Department of Justice as a whole, the International Assistance Group and the RCMP as allegedly taking steps to thwart his lawsuit "through delay, detention or extradition", ultimately to conceal from the public the harm that has been caused to Mr. Mulroncy, Mr. Schreiber and their respective families. He also states that he has witnessed first-hand the "Liberal Underground Government's" attempts to "frustrate the policies of the legitimately-elected Conservative [Mulroncy] government of Canada" when he was the Chairman of Thyssen-Bearhead Industries in 1985. In relation to this submission, he states the following:

*Thyssen, the Canadian soldiers, the people of Nova Scotia, Quebec and I have been misused and betrayed after Thyssen spent more than \$60 Million on the project for peacekeeping and environment ... protection.*

Mr. Schreiber goes on to describe himself as "a Conservative on an international level" who has made a significant contribution to this country by bringing jobs and considerable funds into Canada. He takes the position that a Conservative Minister of Justice is more likely to review his case from an impartial point of view, but he is concerned that, you will be "shielded" from the information he is attempting to put before you in this matter by those persons who are the subjects of his lawsuit.

He also believes that the current Conservative government is unaware of his civil action in Alberta since officials of the Department of Justice have recently sought the production of records concerning his business and any payments he may have made to Mr. Mulroncy. Moreover, they are seeking an order to set aside the examination of Allan Rock in this matter. Mr. Schreiber views these

- 4 -

actions as inconsistent with Prime Minister Harper's position that he would "clean up the Government in Ottawa". He also wonders "*how you will ever get to know what is going on if you have to rely on the advice of the IAG who are the enemies of the Canadian Conservatives in this case since 1995.*"

Mr. Schreiber goes on to criticize your predecessor's decision to surrender him to Germany and suggests that your predecessor was either implicated in concealing the so-called "Political Justice Scandal" or "was totally under the control of the IAG and ignorant" when he ordered Mr. Schreiber's surrender. Moreover, he condemns Canada's practice regarding the extradition of its nationals, particularly in cases where there is no reciprocity. In this regard, he argues that your predecessor was aware that Germany would "never extradite one of its Nationals to Canada" but, nevertheless, proceeded to order his surrender. Regarding the negotiation of extradition treaties which do not involve reciprocity, Mr. Schreiber takes the view that the Canadian government misled the Canadian House of Commons when these treaties were ratified since, based on his review of Canada's treaties, reciprocity is "the most elementary common basis of each Treaty".

Finally, Mr. Schreiber appeals to you to "clean up...the 'Airbus' affair and the 'Political Justice Scandal'" by personally exercising your jurisdiction on the issue of his surrender to Germany. He asks that you reconsider his case with a view to exposing "*the biggest 'Political Justice Scandal' in Canadian history and to bring to an end the nightmare of this case for my family and me.*"

Prepared by:

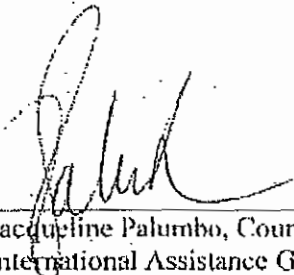
  
Jacqueline Palumbo, Counsel  
International Assistance Group

Reviewed by:

  
Janet Hechey, General Counsel and Associate Director  
International Assistance Group





Department of Justice / Ministère de la Justice  
Canada / Canada

## FACSIMILE TRANSMISSION TRANSMISSION PAR TÉLÉCOPIEUR

SEND TO / ENVOYER À		FROM / DE	
Name / Nom: Karlheinz Schreiber		Name / Nom: Jean-Michael Gabrario, Legal Assistant for Jacqueline Palumbo	
Address / Adresse:  7 Bittern Court Rockliffe Park Ottawa, Ontario K1L 8K9		Address / Adresse:  Justice Canada International Assistance Group 284 Wellington Street Suite 2288 Ottawa, Ontario K1A 0H8	
Fax # / No du télécopieur: 613-748-9697	Tel. No. / No du Tél:	Fax # / No du télécopieur: 613-957-8412	Tel. No. / No du Tél: 613-946-0314
Comments / Commentaires:  Re: Karlheinz Schreiber - Extradition request from the Federal Republic of Germany - Request for Reconsideration of Minister's Surrender Decision			
<b>SECURITY INSTRUCTIONS / INSTRUCTIONS SÉCURITÉ</b>			
Unclassified documents only VIA clear transmission. Protected information permitted within Justice secure FAX network.		Documents non cotés à transmettre sans protection. Renseignements protégés par le réseau des télécopieurs protégés de la Justice.	
Protected documents? Documents protégés?	<input checked="" type="checkbox"/> Yes <input type="checkbox"/> Oui	<input type="checkbox"/> No <input type="checkbox"/> Non	
<b>Transmission</b>			
Pages (Including cover sheet) 2	Date: 14/11/2006	Time: 1:45 PM	



Department of Justice  
Canada

Ministère de la Justice  
Canada

International Assistance Group  
Federal Prosecution Service  
284 Wellington Street, EMB-2291  
Ottawa, Ontario  
K1A 0H8

Telephone: 613-957-3489  
Facsimile: 613-957-8412

November 14, 2006

**BY FACSIMILE: 613-748-9697**

Karlheinz Schreiber  
7 Bittern Court  
Rockliffe Park  
Ottawa, ON K1L 8K9

Dear Mr. Schreiber:

**Re: Karlheinz SCHREIBER**  
**- Extradition request from the Federal Republic of Germany**  
**- Request for Reconsideration of Minister's Surrender Decision**

I am writing to acknowledge receipt of your further submissions to the Minister of Justice in the above matter. Your letter dated October 25, 2006 was received by the Minister's Office on November 1, 2006 and your attachments were received by the Minister's Office on October 30, 2006.

Yours sincerely,

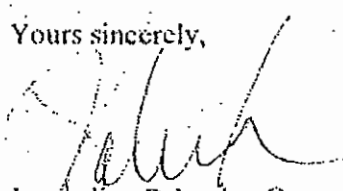

Jacqueline Palumbo, Counsel  
International Assistance Group  
Federal Prosecution Service

c.c. Edward Greenspan, Q.C., Greenspan, White (fax: 416-366-7994)

KARLHEINZ SCHREIBER

7 BITTERN COURT, ROCKCLIFFE PARK  
OTTAWA, CANADA K1L 8K9

TELEPHON 613 748 7330  
TELEFAX 613 748 9697  
schreiberbarbel@aol.com

The Hon. Stockwell Burt Day P.C., M.P.  
Minister of Public Safety

House of Commons  
Ottawa, Ontario  
K1A 0A6

Ottawa, November 30, 2006

**Subject: "Political Justice Scandal" and the RCMP**

Dear Minister,

I am referring to my letter September 25, 2006 I have sent to you.

The attached letter from the Commission for Public Complaints Against the RCMP, November 15, 2006 is for your personal information.

Yours sincerely

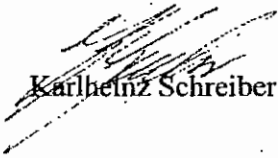

Karlheinz Schreiber

Copy to The Right Hon. Stephen Harper  
Prime Minister

Commission for Public Complaints Against the  
Royal Canadian Mounted Police

Commission des plaintes du public contre la  
Gendarmerie royale du Canada

7337 137 Street, Suite 102  
Surrey, British Columbia V3W 1A4  
Tel.: (604) 501-4080 / Fax: (604) 501-4095  
Toll-Free: 1-800-665-6878

7337 rue 137, pièce 102  
Surrey, Colombie-Britannique V3W 1A4  
Tél.: (604) 501-4080 / Télécopieur : (604) 501-4095  
Sans Frais : 1-800-665-6878

November 15, 2006

File No. PC-2006-1847

Mr. Karlheinz Schreiber  
7 Bittern Court, Rockcliffe Park  
Ottawa, ON K1L 8K9

Dear Mr. Schreiber:

In accordance with the *RCMP Act*, your complaint was forwarded today to the Commissioner of the RCMP for appropriate action. A copy of the complaint is enclosed for your information.

The Commissioner is required to provide written acknowledgment of your complaint within 45 days of receiving it. He is also required to provide you with a status report every 30 days thereafter. When the Commissioner has dealt with the complaint, you will be informed of the outcome.

Should you be dissatisfied with the RCMP's response to your complaint, you may contact this office to request a review by this Commission.

The Commission for Public Complaints Against the RCMP is an agency independent of the RCMP whose role is to receive and review complaints from the public about the conduct of members of the RCMP while on duty.

I am sending you a pamphlet on the Commission that you may find useful. Please read it and the attached copy of your complaint, and contact me at (604) 501-4080 or at our toll free number, 1-800-665-6878, if you have any questions.

Yours truly,

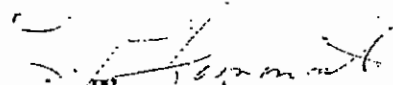
  
Lorraine Blommaert  
Enquiries and Complaints Analyst

LB:GS  
Enclosures

Canada



Royal Canadian  
Mounted Police

Gendarmerie royale  
du Canada

Security Classification/Designation  
Classification/désignation sécuritaire

Protected A

Professional Standards Unit  
Coventry Square Bldg, Room 5-D14  
295, Coventry Rd.  
Ottawa, Ontario K1A 0R2

Mr. Karlheinz Schreiber  
7 Bittern Ct, Rockcliffe Park  
Ottawa, Ontario  
K1L 8K9

Your File - Votre référence

Our File - Notre référence

HQVII061401293

Date

November 28, 2006

Object **Public Complaint Against Commissioner Murray, Commissioner Zaccardelli,**  
Sujet **Supt. Mathews, Insp. McLean, Insp. Brettschneider and S/Sgt. Feigenwald.**

Mr. Schreiber,

The present is to acknowledge receipt of your complaint dated November 14, 2006, lodged against the above-mentioned RCMP officers. Please noted that Commissioner Murray, Insp. McLean and S/Sgt Feigenwald have retired from the Royal Canadian Mounted Police and are not subject to an investigation pursuant to the RCMP Act.

A member of the RCMP will be appointed to investigate this matter and will be in touch with you shortly. You will be notified of the status of the investigation into your complaint within forty-five days from the date we received it and on a monthly basis thereafter, until we are in a position to advise you of the results of our findings.

Yours truly,

S/Sgt Michael Robineau  
NCO i/c Professional Standards Unit

cc Commissioner Zaccardelli  
Supt. Allan Mathews  
Insp. Rainer Brettschneider

Canada

RCMP GRC 2823 (2002-11) WPT

Page 1 of/de 1



Tel.780.423.1888  
Fax.780.424.0934  
www.hladun.com

100, 10187 - 104 Street, inquiries@hldun.com  
Edmonton Alberta  
T5J 0Z9

15,737.1

Our File

Your File

November 15, 2006

The Honourable Mr. Vic Toews  
Minister of Justice and  
Attorney General of Canada  
Suite 306, Justice Building  
House of Commons  
Ottawa, ON K1A 0A6

Via fax: (613) 995-1049  
(Original sent registered mail)

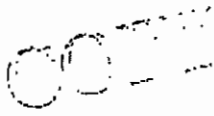

Dear Sir:

**Re: *Karlheinz Schreiber v. The Attorney General of Canada et al*  
Q.B. Action #9703 20183**

I act on behalf of Karlheinz Schreiber in relation to a lawsuit he commenced against the Attorney General of Canada on October 24, 1997. I am writing to you in connection with this lawsuit. This letter is not intended nor should it be construed to be further submissions in relation to your responsibility under the *Extradition Act*. The lawsuit arose as a result of a Letter of Request ("Request") of September 29, 1995 prepared by counsel from your International Assistance Group ("IAG") and sent to the Swiss authorities. The Request became a cause celebre because of its allegations of wrongdoing by politicians and by Mr. Schreiber.

Mr. Schreiber's lawsuit is serious and has been pursued as assiduously as possible, bearing in mind the extradition proceedings commenced against Mr. Schreiber in August, 1999. Examinations for Discovery of some Crown witnesses have been held and will be concluded in the next few months. The Crown's Affidavit of Records was provided on October 20, 2006 and is being reviewed for the purposes of the lawsuit. It is anticipated that Mr. Schreiber will be examined once the examinations of the Crown witnesses are concluded.

On April 22, 2003, the RCMP announced their "investigation" relating to the Request for Assistance and allegations of wrongdoings could not be substantiated, save for a charge of fraud against MBB Helicopters Canada (Eurocopter Canada). The Court found insufficient evidence to commit Eurocopter to stand trial and discharged Eurocopter at the preliminary Inquiry. Over the years, Mr. Schreiber, a Canadian citizen and successful businessman, has been subject to egregious treatment and the subject of a RCMP investigation conducted in bad faith, designed to entrap Mr. Schreiber, and bring him into disrepute. The culmination of the RCMP actions have led Mr. Schreiber to make a complaint to the Commission for Public Complaints against the RCMP, a copy of the complaint is enclosed for your review.

I am writing to you to retract the Ministerial Order to extradite Mr. Schreiber to Germany and I do this on the basis that Mr. Schreiber, a citizen of Canada has the right and legitimate expectation to remain in Canada in order to prosecute his case. It is highly unlikely that he will be able to do so

*The Honourable Mr. Vic Toews  
Minister of Justice and Attorney General of Canada  
November 16, 2006  
Page 2*

were he to be surrendered to Germany in light of the comments made by Karl-heinz Haessler, Judge of the Augsburg Regional Court and by Reinhard Nemetz, the Chief Senior Prosecutor of the Augsburg Prosecution Office. Mr. Schreiber's inability to prosecute his case would be a travesty of justice when regard is had to the overall political background of the Airbus investigation.

The Minister must also retract the Ministerial Order on the basis that there is a reasonable apprehension of bias in relation to the conduct of the IAG and its ongoing involvement in the Schreiber case since 1995 and, in the result, the actions of the IAG and the Minister in not having retained independent counsel to defend Mr. Schreiber's lawsuit, such as to bring the administration of justice into disrepute. Any reasonable person, understanding all of the facts of the case, could come to no other conclusion but that the actions of the IAG and the Department created an apprehension of bias.

Please review this matter in the context of the actions of the IAG, the fact that Mr. Schreiber commenced his lawsuit in October, 1997, the fact that the RCMP investigation was tainted and scurrilous, and the fact that Mr. Schreiber is entitled to have his day in Court. Please advise whether you will retract or withdraw the Ministerial Order for Mr. Schreiber's extradition, pending completion of his lawsuit in the Court of Queen's Bench of Alberta.

Yours truly,

**HLADUN & COMPANY**

*Dictated by/ not read and  
Signed in the writer's absence to avoid delay*

**ROBERT W. HLADUN, Q.C.**

RWH/ms

Enclosure

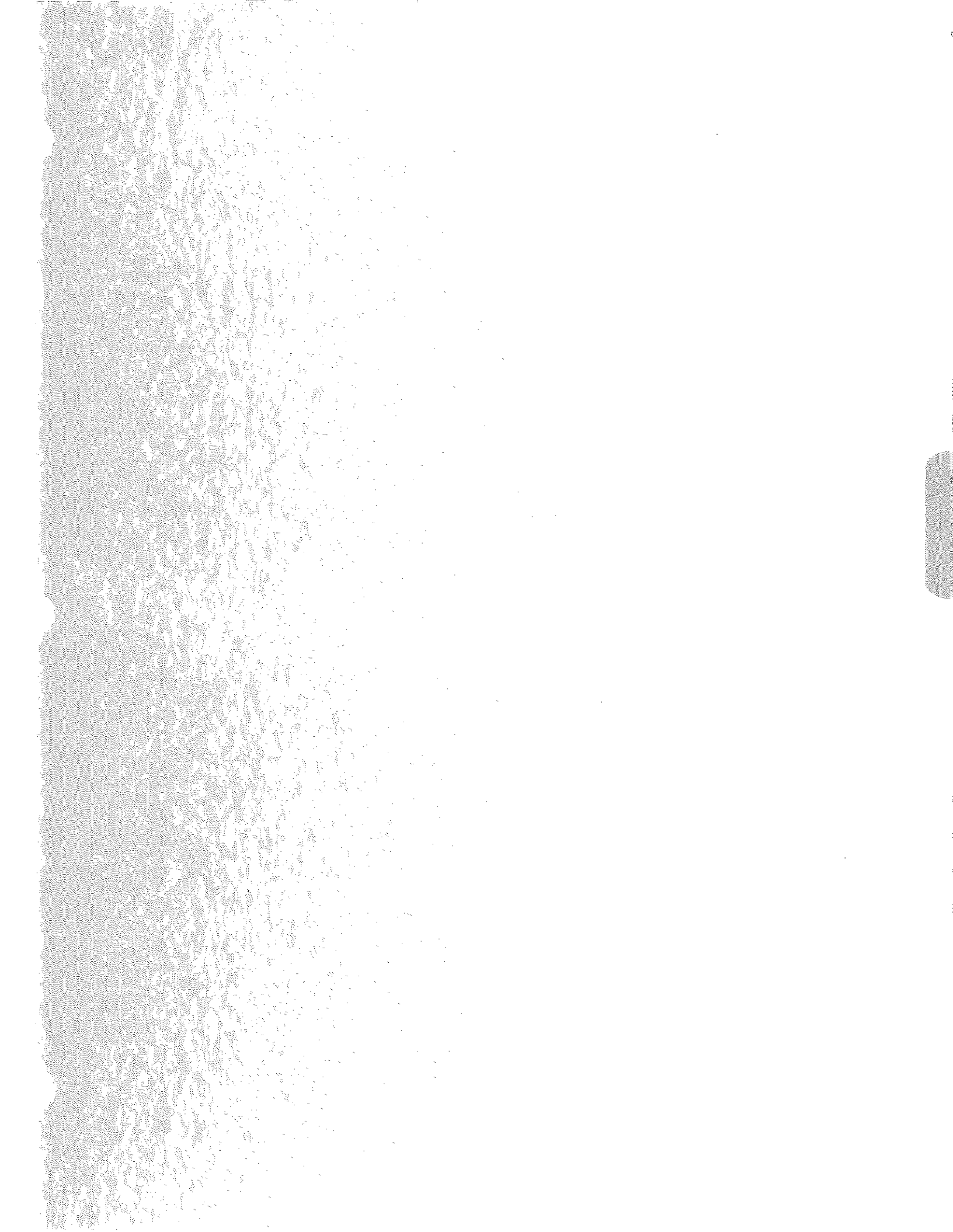



KARLHEINZ SCHREIBER

7 BITTERN COURT, ROCKCLIFFE PARK  
OTTAWA, CANADA K1L 8K9

TELEPHONE 613 748 7330  
TELEFAX 613 748 9697  
schreiberbarbel@aol.com

Personal

Per Fax [1] 514 4369 9393

The Right Hon. Brian Mulroney, P.C., LL .D.  
47 Forden Crescent  
Westmount, Quebec  
H3Y 2Y5

Ottawa, January 19, 2007

Dear Brian,

I am sending you via fax 22 copies of some letters:

My letter of January 16, 2007 to the Prime Minister, The Right Hon. Stephen Harper,

The letter of December 1, 2006 from the then-Minister of Justice, The Hon. Vic Toews to my Lawyer Edward Greenspan Q.C. and

The Fax-Letters November 14, 2006 and November 16, 2006 from the IAG of the Department of Justice to me.

On October 25, 2006 I sent to you a copy of my Letter to the then Minister of Justice, The Hon. Vic Toews.

When you look at the letters you can easily see who is controlling the Department of Justice. The Conservative Government is now protecting the people responsible for the Mulroney – “Airbus” – Vendetta and the “Political Justice Scandal”, backing all the lies of the then-Liberal Minister of Justice, The Hon. Irwin Cotler.

I am convinced that you will understand that I am pretty surprised about this situation bearing in mind all the pain and damages our families faced during the past.

Dear Brian, I am very interested to learn from you how you feel about this situation and what your intentions are to deal with it.

The Vendetta did great harm to the families of Gary Ouellet, Frank Moores, yours and mine.

The "Political Justice Scandal" will not come to an end as long as my lawsuit against the Minister of Justice and Attorney General of Canada moves ahead.

I strongly believe that after 13 years the time has come for you to support my legal battle and that you have an obligation towards the Canadian taxpayers, your family, your friends and yourself to ask together with me for an inquiry.

An independent inquiry is in my opinion the only way for a clean up in Ottawa and to bring the truth to light for all Canadians and for ourselves.

I am looking forwards to hear from you in the very near future.

Yours sincerely

A handwritten signature in cursive script, appearing to read "Alan Stein".

PS. I just received a letter from the RCMP concerning my Public Complaint.  
Copy attached.

KARLHEINZ SCHREIBER

7 BITTERN COURT, ROCKCLIFFE PARK  
OTTAWA, CANADA K1L 8K9

THELEPHON: 613 748 7330  
FACSIMILE: 613 748 9697  
schreiberbarbel@aol.com

Ottawa, January 16, 2007

**Personal, for his eyes only**

The Right Hon. Stephen Joseph Harper P.C., M.P.  
Prime Minister  
House of Commons  
Ottawa, Ontario  
K1A 0A6

**Subject: "Political Justice Scandal"**

Dear Prime Minister,

On October 27, 2006 I took the liberty to send you a copy of my letter October 25, 2006 to the Hon. Vic Toews, then the Minister of Justice and Attorney General of Canada for your personal information.

On November 30, 2006 I took the liberty to send you the copies of two facsimiles dated November 14<sup>th</sup> and 15<sup>th</sup> from the IAG of the Department of Justice for your personal information.

Today I take the liberty to send you the copy of the facsimile of December 14, 2006 from the IAG of the Department of Justice together with a letter, December 1, 2006 from The Hon. Vic Toews which was sent to my lawyer, Edward Greenspan Q.C., LL.D., D.C.L.

**The letter of The Hon. Vic Toews, then the Minister of Justice and Attorney General of Canada opens the door to the next dimension of the biggest "Political Justice Scandal" in Canadian history!**

Dear Prime Minister, assume you would hear this story:

*A Liberal Minister of Justice and Attorney General teamed up with a journalist, a confidential police-informant and complainant, the Solicitor General, the Police Commissioner, officials of the Department of Justice, officers of the police force and a police informant with a criminal record from an other country, to start a conspiracy and political vendetta including allegations of bribe and fraud against a former Conservative Prime Minister and his friends.*

*The conspiracy and vendetta started 12 years ago and is still moving ahead.*

*It cost millions of taxpayers' money and continues to do so.*

*No charges were ever laid*

*The lawsuit of the former Conservative Prime Minister was settled, but the vendetta continued for ten years.*

*One other victim of the vendetta filed ten years ago an ongoing lawsuit against the Liberal Minister of Justice and the Attorney General.*

*The Department of Justice tries to thwart the lawsuit through delay, extradition without treaty obligations and detention with the involvement of the police and an undercover agent hired from a foreign country, ultimately conceal from the public the truth about the vendetta, the abuse of power and the "Political Justice Scandal"*

*The Liberal Minister of Justice and Attorney General who initiated the vendetta refuses to appear for examinations for discovery because he is not the responsible Minister today.*

*The Liberal Minister and Attorney General responsible for the lawsuit and the extradition case lies about his obligations under an extradition treaty and writes in a letter October 31, 2004: "I was not the Minister of Justice at the time the impugned actions were taken and therefore, I have no bias against Mr....."*

*After 12 years in opposition, the Conservative Party formed a new government. The Conservative Minister of Justice and Attorney General is supporting his Liberal predecessors' scandal-hiding activities, denies the existence of the "Political Justice Scandal" and backs his lies!*

Dear Prime Minister, would you have ever believed that this story is a real Canadian story and the Conservative Minister of Justice and Attorney General was a member of your government?

It seems to be a matter of fact that there is no need for a government clean-up in Ottawa because the Liberal Government did the necessary clean-up when they put in place the Gomery inquiry and the Maher Arar inquiry.

It looks like the situation has changed since 30 November 2005 when you announced that a Conservative Government would appoint an Independent Director of Public Prosecutions and you referred especially to the Mulroney - Airbus affair (documents attached).

I believe when you read my letter to The Hon. Vic Toews and his reply to my lawyer Edward Greenspan, Q .C. you will come to the same conclusions I came:

The Hon. Vic Toews    Did not read my letter and the attachments  
                                  just signed the letter, written by the IAG  
                                  did not see my letter and his signature is a rubber stamp  
                                  had a reason to ignore or deny my allegations and facts  
                                  had a reason to support the Liberals  
                                  was not interested to clean up his department  
                                  was not interested to inform Canadians about the scandal  
                                  was told that the Conservative Government is not interested to  
                                  call an inquiry for their one reasons.  
                                  writes in his letter on page 5 paragraph 6:

**“In addition, Mr. Schreiber is at liberty to use any other public venue available to convey any information which he deems to be of interest to the public.”**

Is he recommending the CBC's Fifth Estate or the political opposition?

Dear Prime Minister, I ask you in the interest of the Canadian taxpayer to grant me the courtesy to read my letter to The Hon. Vic Toews and his reply to Mr. Edward Greenspan and the attachments. Please let me know whether you share the Minister's views. I told you since June 2006 that I strongly believe that this case will not disappear by itself. Only an independent inquiry can achieve a proper clean up and return fundamental Justice to the Department of Justice and the RCMP to make sure that the same will not happen again in the future.

Yours sincerely



Karlheinz Schreiber

Copy to The Right. Hon. Brian Mulroney

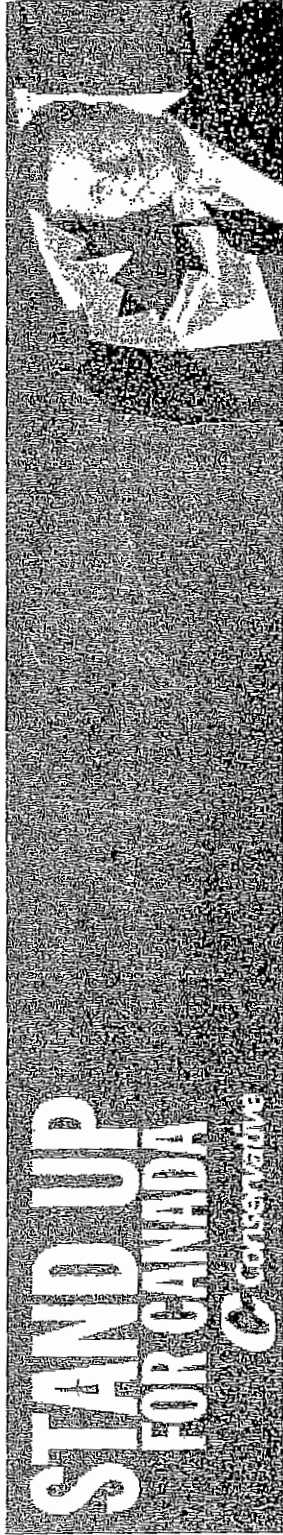

## Director of Public Prosecutions

[Click here for PDF version](#)

### THE ISSUE

The Liberal Party's 12 years in power have been 12 years of consecutive scandal. Despite Paul Martin's promises to clean up Ottawa, nothing has changed. Worse, the Liberals have made no attempt to ensure that those responsible for these scandals pay the price – and they still pretend they are victims in the sponsorship scandal!

Judge Gomery concluded that the Liberal Party "as an institution cannot escape responsibility for the misconduct of its officers and representatives."<sup>2</sup> Unfortunately, the current system of lap-dog oversight means Liberals get to hold themselves accountable. They negotiated with themselves to calculate how much taxpayers' money the Liberal Party would repay.<sup>3</sup> They cut a deal letting Paul Coffin repay only \$1 million even though he stole \$1.6 million by fraud.<sup>4</sup>

Additional examples of the need for prosecutorial independence:

- François Beaudoin, former president of the Business Development Bank of Canada, was subjected to a vendetta after refusing the prime minister's request to give a loan to a personal friend. The vendetta included complaints to the RCMP that Justice André Denis of the Québec Superior Court later called "completely vexatious and without foundation." After the Crown Attorney concluded that there was no reason to charge Beaudoin, the government-owned Bank, headed by a political appointee, refused to accept the outcome and hired a lawyer to try (unsuccessfully) to influence the prosecutor to change the decision.<sup>5</sup>
- The Muirney-Airbus affair: Officials in the federal Department of Justice advised the RCMP during its investigation and it was the Justice Department that signed and sent the letter asking the Swiss authorities to cooperate. The Department's letter wrongly indicated that the RCMP had reached conclusions about criminal activity and then-Attorney General Allan Rock subsequently apologized in writing. To avoid any possibility of interference, this is precisely the sort of issue that should have been handled by an independent Director of Public Prosecutions.

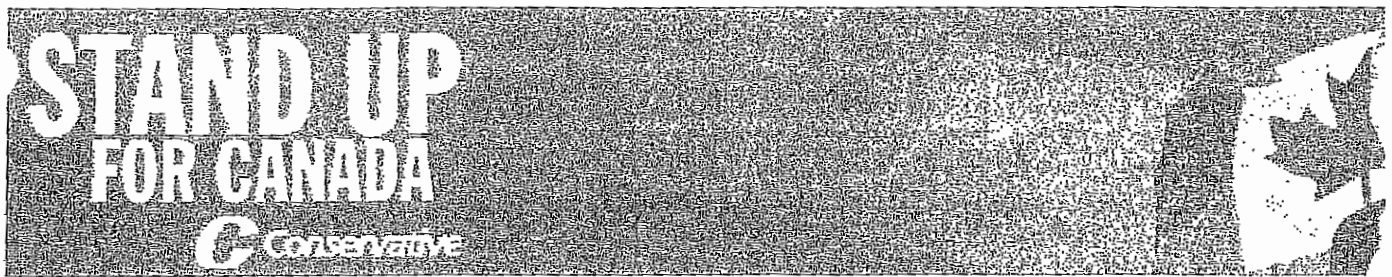

Stand Up for Accountability

*Let's clean up government*

Canadians have been let down by 12 years of Liberal scandal. We need a change in government to restore accountability and end the culture of entitlement. Canadians must be able to trust our government and know that our tax dollars are well spent.

A Conservative government will provide the leadership to stand up for honesty and integrity in government. Our first piece of legislation will be a *Federal Accountability Act*, a sweeping reform plan to clean up government.

**The Conservative Party will stand up for:**

- Ending the influence of big money in politics by banning corporate and union political donations, and limiting individual donations to \$1000.
- Tough new lobbying rules and an end to the revolving door that allows former ministers, political aides, and top bureaucrats to turn around and lobby the government.
- Giving more power and teeth to independent watchdogs such as the Auditor General and Ethics Commissioner, protecting whistleblowers from reprisal, and strengthening access to information laws to give citizens the right to know.
- Appointing an independent Director of Public Prosecutions to protect criminal prosecution from political interference.

**Best Western** THE LOWEST RATE GUARANTEED On our hotels ONLY AT BestWestern.com Check Rates NOW

**AOL NEWS** AOL Search

MAIN NATIONAL WORLD BUSINESS ENTERTAINMENT SPORTS HEALTH WEATHER

Home

LATEST HEADLINES: Coretta Scott King's Will Filed in Court Injured Hiker Found After 3 Days in

- News
- Did You See That
- Letters to the Editor
- News Alerts
- Odds & Ends
- Quips & Quotes
- Autos
- Careers
- Computing
- Entertainment
- Finance
- Health
- Life & Style
- Red
- Shopping
- Sports
- Travel

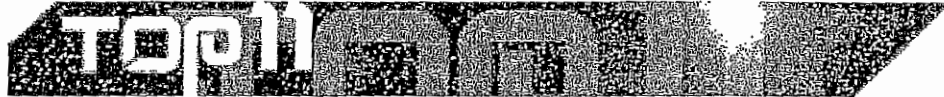

## Top 11 Political Leaks and Scandals

Scandals and leaks are all part of what makes a government or a politician sink or swim. Well-timed, intentional leaks can help sway an election, while unexpected revelations can ruin a career. Take a look at some of the best-known affairs on record.

Member's  
Should emp  
workers tim  
sporting eve  
Read more

Yes

No

Vote



(1 of 11)



**1972- Watergate:** 'Deep Throat' may well be the most famous political leaker of all time. Last year he revealed himself to be Mark Felt, the associate director of the FBI at the time of the Watergate scandal. Until then, Felt's identity had been the best kept secret in the United States, protected by the Washington Post journalists who were informed by Deep Throat and who broke the story of President Richard Nixon's illicit actions. The journalists, Bob Woodward and Leonard Bernstein, as well as Deep Throat were immortalized in the film 'All the President's Men.' (Getty Image)

Get Organized



Eight Risk Free issues of Time



**Best Western** THE LOWEST RATE GUARANTEED. On our hotels ONLY AT [BestWestern.com](http://BestWestern.com) Check Rates NOW

**AOL news** AOL Search

[Home](#)
[NATIONAL](#)
[WORLD](#)
[BUSINESS](#)
[ENTERTAINMENT](#)
[SPORTS](#)
[HEALTH](#)
[WEATHER](#)

Home LATEST HEADLINES:sh. Injured Hiker Found After 3 Days in Wash. Pa. Primary to Test Vote

- News
- Did You See That
- Letters to the Editor
- News Alerts
- Odds & Ends
- Quips & Quotes
- Autos
- Careers
- Computing
- Entertainment
- Finance
- Health
- Life & Style
- Red
- Shopping
- Sports
- Travel



## Top 11 Political Leaks and Scandals

Scandals and leaks are all part of what makes a government or a politician sink or swim. Well-timed, intentional leaks can help sway an election, while unexpected revelations can ruin a career. Take a look at some of the best-known affairs on record.

Member's  
Should emp  
workers tim  
sporting eve  
Read more

- Yes
- No

[Vote](#)



(8 of 11)



**1995- Sponsorship scandal:** Though the federal sponsorship scandal really came into the public awareness in the early years of the new millenium, sponsorship leaker, Allan Cutler blew his whistle way back in 1995. The former bureaucrat is credited with bringing the shady advertising deals made under Jean Chretien out of the back rooms and into the limelight, he even lost his job in the process. We've since seen several names dragged through the mud for during the Gomery Inquiry and the scandal arguably played a significant role in putting a Liberal government out of power. (CP Image)

### Get Organized



Eight Risk Free issues of Time

05-03-06 18:31 EDT



## FACSIMILE TRANSMISSION TRANSMISSION PAR TÉLÉCOPIEUR

SEND TO / ENVOYER À		FROM / DE	
Name / Nom: Edward L. Greenspan Q.C. Counsel	Name / Nom: Lisa Anderson Paralegal		
Address / Adresse: Greenspan, White Barristers 144 King Street East Toronto, Ontario M5C 1G8	International Assistance Group Federal Prosecution Service 284 Wellington Street, EMB-2281 Ottawa, Ontario K1A 0H8		
Fax # / No du télécopieur: 416-368-7994	Tel. No. / No du Tél: 416-366-3961	Fax # / No du télécopieur: 613-957-8412	Tel. No. / No du Tél: 613-941-4157

**Comments / Commentaires:**

**F.R.G. v. Karlheinz SCHREIBER – Request for reconsideration**

se find herewith the Minister's reasons on reconsideration dated December 14, 2006. Please confirm receipt  
lling me at the above noted number or, preferably, by e-mail at [landerso@justice.gc.ca](mailto:landerso@justice.gc.ca). Please note that the  
il will follow via priority post.

### SECURITY INSTRUCTIONS / INSTRUCTIONS SÉCURITÉ

Unclassified documents only VIA clear transmission.  
Protected information permitted within Justice secure  
FAX network.

Documents non cotés à transmettre sans  
protection.  
Renseignements protégés par le réseau des  
télécopieurs protégés de la Justice.

Protected documents?  
Documents protégés?

Yes  
Oui

No  
Non

### Transmission

Pages:

6

Date:

December 14, 2006

Time

5:51 PM

Minister of Justice  
and Attorney General of Canada



Ministre de la Justice  
et procureur général du Canada

The Honourable / L'honorable Vic Toews, P.C., Q.C., M.P./c.p., c.r., député  
Ottawa, Canada K1A 0H8

DEC 1 + 2006

Mr. Edward Greenspan, Q.C.  
Greenspan, White  
Barristers  
144 King Street East  
Toronto ON M5C 1G8

Dear Mr. Greenspan:

I am writing in response to the submissions you addressed to me on May 17, 2006, and August 10, 2006, on behalf of your client, Mr. Karlheinz Schreiber. I am also responding to submissions made directly to me by Mr. Schreiber in a personal letter dated October 25, 2006, including three binders of appendices.

You have asked me to reconsider the surrender decision of my predecessor, the Honourable Irwin Cotler, and rescind the order surrendering Mr. Schreiber to Germany. Mr. Schreiber is also directly petitioning me to reconsider the decision to surrender him to Germany, although I note your correspondence dated November 15, 2006, in which you indicate that Mr. Schreiber's independent submissions do not form part of the reconsideration request that you have presented on his behalf.

You have brought to my attention media reports that quote statements made by Mr. Nemetz, the Chief Prosecutor of the Augsburg Prosecution Office, and Judge Karl-Heinz Haeusler, the judicial spokesperson for the Augsburg Regional Court. You submit that their comments amount to conduct by German authorities that interferes or attempts to interfere with the extradition process in Canada, as was the case in *United States of America v. Cobb* (2001), 152 C.C.C. (3d) 270 (S.C.C.), and that demonstrates that the case against Mr. Schreiber has been prejudged in Germany. Indeed, you submit that the comments made by Judge Haeusler are far more disconcerting, as they relate directly to a prejudgment of the case by a judge and spokesperson for the very Court which will try Mr. Schreiber.

In Mr. Schreiber's additional submissions, he states his belief that my officials, together with members of the former Liberal governments, are engaged in ongoing attempts to ensure his removal in order to halt his ongoing lawsuit in the Alberta Queen's Bench against the former Attorney General of Canada, the Honourable Allan Rock. He claims that the authorities in question are anxious to see him gone in order to prevent him from

Canada

revealing, through his civil action, scandalous information about the former Liberal governments in their treatment of him, of former Prime Minister Brian Mulroney, and of the Canadian public as a whole in the "Airbus" matter.

Mr. Schreiber further accuses my officials of misconduct in allegedly suppressing relevant information about his extradition case from my predecessor and me. He believes that there are certain bureaucratic officials who have Liberal affiliations and, thus, it is in their interest to shield me and, ultimately, the public from information that would expose alleged wrongdoing by members of the former Liberal governments. He asserts that a "Political Justice Scandal" without precedence in Canadian history has been propagated against him, and he urges me not to rely on the advice of counsel in my Department, which he believes to be politically motivated.

He further takes the position, based on his commitment to the Conservative ideology and his Conservative ties, that a Conservative Justice Minister is more likely to be sympathetic to his case.

I have considered your submissions, the additional submissions made to me independently by Mr. Schreiber, as well as my predecessor's surrender decision. For the reasons set out below, I am satisfied that the surrender order of my predecessor, the Honourable Irwin Cotler, should be maintained.

The submissions before me raise claims of abuse of process allegedly committed by both the German and Canadian officials. I have the authority to consider claims of breach of the *Canadian Charter of Rights and Freedoms* (the Charter) and, thus, allegations of abuse of process are relevant to my reconsideration of this case. However, to find an abuse of process, there must be evidence of bad faith or improper motive on the part of the Canadian and/or foreign authorities. As stated by the Supreme Court of Canada [*Cobb, supra*], such a finding will be "extremely rare" and must only be made in the "clearest of cases."

With these principles in mind, I will first address your submissions regarding the actions of the German authorities.

The first article you have provided is from the online version of *Der Spiegel* of March 8, 2006. It contains an interview with Mr. Nemetz, in which he comments on the Ontario Court of Appeal's decision dated March 1, 2006, which upheld the surrender of Mr. Schreiber to Germany. Mr. Nemetz's comments indicate that he was aware that an application for leave to appeal had been filed with the Supreme Court of Canada. He spoke about the length of time the extradition proceedings had taken in Canada and what Mr. Schreiber faced upon return to Germany. In particular, you point out that Mr. Nemetz stated that Mr. Schreiber

would definitely be imprisoned on remand, due to the severity of the charges, and the public prosecutor would "vehemently" protest against releasing him on bail.

You submit that this clearly reflects a prejudgment of the availability of bail pending trial for Mr. Schreiber.

The second article you have submitted appeared on the Deutsche Presse-Agentur Web site on March 9, 2006. It included statements made about Mr. Schreiber by Judge Haeusler, the judicial spokesperson for the Court. You submit that the statement by Judge Haeusler that Mr. Schreiber is "the trigger of the entire affair" (the Christian Democratic Union, or CDU; contributions scandal), demonstrates that the Court has prejudged Mr. Schreiber's guilt and that he will not have a fair trial in Germany. Furthermore, you submit that it would appear that Mr. Schreiber is being held responsible for the entire CDU contributions scandal, the largest political scandal in German history.

In light of your submissions, my officials contacted German authorities. They advised that:

- Judge Karl-Heinz Haeusler is the judicial spokesperson for the Augsburg Regional Court's Criminal Division;
- Neither Judge Haeusler nor Mr. Nemetz will have any involvement in Mr. Schreiber's case;
- Mr. Nemetz's comments reflect the position that the prosecution is expected to take on bail, rather than being a predetermination of the outcome of issue of bail pending trial; and
- If surrendered to the Federal Republic of Germany, Mr. Schreiber must be taken into custody. He will be taken before the court without delay for a bail hearing and the court will decide the issue of bail pending his trial.

In *Cobb*, the assigned trial judge in the United States stated, while sentencing a co-accused, that if the fugitives, who were Canadian citizens fighting extradition from Canada, did not cooperate and come to the United States voluntarily, he would impose the absolute maximum jail sentence that the law permitted. Furthermore, the prosecutor assigned to the case appeared on "The Fifth Estate," a Canadian television program, and threatened that those fugitives who contested their extradition would serve longer sentences under much more stringent conditions, and would "be the boyfriend of a very bad man," an apparent reference to the possibility of homosexual rape in prison.

In my view, the circumstances of Mr. Schreiber's case are not comparable. It is difficult to construe what was said by Mr. Nemetz and Judge Haeusler as threats directed towards intimidating Mr. Schreiber into giving up his right to lawfully resist extradition. The extradition proceedings against Mr. Schreiber have been ongoing for over seven years. In my view, there is nothing in either man's comments to suggest that Mr. Schreiber would find himself in a more favourable position if he returned voluntarily to Germany, or be treated more harshly for not doing so.

Moreover, unlike *Cobb*, where the impugned comments were made by the prosecutor and judge assigned to the defendant's case, Mr. Nemetz is not the prosecutor assigned to Mr. Schreiber's matter, and Judge Haeusler is not the assigned trial judge.

In so far as the decision in *Cobb* dealt with the fairness of the extradition hearing, rather than the fairness of the trial in the foreign jurisdiction, it provides little guidance in determining whether there is any merit to the concerns raised on Mr. Schreiber's behalf.

I must be satisfied that the surrender of Mr. Schreiber would not be unjust or oppressive, having regard to all the relevant circumstances. I take for granted that an impartial tribunal is essential for a fair trial, and that surrender to a tribunal which is not impartial would violate the principles of fundamental justice and be contrary to section 7 of the Charter.

In my view, there is no basis to believe that Mr. Schreiber will not receive a fair trial before an impartial tribunal in Germany. As stated above, neither Mr. Nemetz nor Judge Haeusler will participate in Mr. Schreiber's case. The indictment against Mr. Schreiber is pending before the 10<sup>th</sup> Criminal Division of the Augsburg Regional Court, over which Judge Klaus Scheizig presides, along with two professional judges (Mr. Stephan Knoepfle and Mr. Martin Barnickel) and, according to German law, Mr. Schreiber is presumed innocent until proven guilty and has the right to a fair trial. If surrendered, he must be taken into custody. However, he will be brought before the Court, which will determine the issue of bail pending his trial.

In the Canadian criminal justice system, the scope for public comment by participants in ongoing cases is limited for fear of prejudicing an accused's right to full answer and defence, and it is therefore unlikely that a Canadian judge would speak publicly about a case before the court.

Canada's approach to minimizing pretrial publicity and commentary by participants in the process in ongoing criminal matters has not, however, impeded extradition to other countries, such as the United States, where there is a much greater tolerance for public

statements by participants during the course of criminal proceedings. The right to a fair trial before an impartial tribunal is no less of a concern in the United States. Indeed, it is a fundamental right under the U.S. constitution. It is simply differently achieved in the U.S. system (*The Queen v. Bain*, [1992] 1 S.C.R. 91). It follows that the fact that other countries' criminal justice systems do not operate on the same model as our own does not mean that they are fundamentally unfair (*Republic of Philippines v. Pacificador*, [1993] 14 O.R. (3d) 321 (Ont. C.A.); *Canada v. Schmidt*, [1987] 1 S.C.R. 500).

While there is no exact equivalent in Canada to the post of judicial spokesperson, it is obvious that it is a feature of the German system of justice. Accordingly, in the German system, it must be that there is no necessary conflict between a judicial spokesperson commenting on a prosecution and the state's ability to guarantee a fair trial.

In my view, even if it could be concluded that Judge Haeusler's comments could potentially give rise to prejudice for Mr. Schreiber, this is a matter where the German courts should be trusted to deal with the issue and fashion a remedy, if necessary.

I now turn to Mr. Schreiber's separate submissions alleging misconduct on the part of the Canadian authorities, particularly members of the former Liberal governments and the officials who advised them. Having reviewed Mr. Schreiber's claims of bad faith on this front, I find them to be unfounded and based on speculation.

First, there is no basis to his assertion that the extradition case against him is part of a broader scheme by Department of Justice Canada and other Canadian government officials to guarantee the failure of his lawsuit. His surrender to Germany would not, of necessity, lead to a termination of his civil action against the former Attorney General of Canada. Mr. Schreiber has legal representation in that matter and his presence in Canada is not a prerequisite to its continuation.

Similarly, there is no merit to his contention that members of the former Liberal governments and the government officials who advised them are using the extradition process to silence him from disclosing, through his lawsuit, important information about the so-called "Airbus affair." As I already indicated, the outstanding civil case in Alberta may proceed with or without his presence in Canada. In addition, Mr. Schreiber is at liberty to use any other public venue available to convey any information which he deems to be of interest to the public.

Finally, Mr. Schreiber has provided absolutely no evidence to support his serious charge that my officials, including members of the International Assistance Group, may have concealed information about his extradition case from my predecessor and/or me in order to advance politically-motivated interests. It is the practice of my Department to put before the presiding Justice Minister all of the original submissions

made by a person sought for extradition in his or her petition against surrender. It is clear from former Minister Cotler's letter to you dated October 31, 2004, in which he orders Mr. Schreiber's surrender, that he had personally received all of the numerous submissions which you made on Mr. Schreiber's behalf. Likewise, I have before me your submissions on Mr. Schreiber's petition for reconsideration and his independent submissions to assist me in personally considering whether there is a legitimate basis on which to interfere with my predecessor's decision.

Therefore, Mr. Schreiber's denunciation of the officials advising me or my predecessor on the question of surrender is entirely unsubstantiated.

For the above reasons, I do not find that the extradition matter against Mr. Schreiber has been pursued for any improper objective. The extradition request was based on evidence in support of the German charges, and a Canadian court has determined that a committal order was warranted on the force of that evidence. The committal order was reviewed by the Ontario Court of Appeal and upheld.

It is also of note, in reviewing Mr. Schreiber's claims of bad faith, that during the course of the extradition proceedings in this case, which commenced with his provisional arrest in August of 1999, he has had every opportunity to pursue his legal rights as a person sought for extradition in Canada. His efforts to oppose his extradition to Germany have been given full consideration at both the judicial and ministerial phases of the extradition process. Indeed, he continues to pursue these avenues, and he is free to do so, through this petition for reconsideration, as well as his outstanding application in the Supreme Court of Canada to appeal his committal for extradition and my predecessor's decision to surrender him to Germany.

In summary, I do not find that the integrity of the extradition process has in any way been eroded in this case. As such, this is not one of those "extremely rare" cases in which a refusal to surrender would be justified.

In all the circumstances, I am satisfied that Mr. Schreiber's surrender would not be unjust or oppressive or contrary to section 7 of the Charter. Accordingly, I am not prepared to alter the decision on surrender.

I thank you for providing me with your submissions.

Yours sincerely,

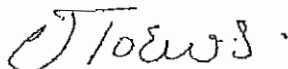

Vic Toews





Department of Justice / Ministère de la Justice  
Canada / Canada

## FACSIMILE TRANSMISSION

SEND TO		FROM	
Name:	Karlheinz Schreiber	Name:	Julie Fitton for Jacqueline Palumbo Counsel
Address:	7 Bittern Court Rockliffe Park Ottawa, Ontario K1L 8K9		International Assistance Group Federal Prosecution Service East Memorial Building, Room 2291 284 Wellington Street Ottawa, Ontario K1A 0H8
Fax #:	Tel. #:	Fax #:	Tel. #:
613-748-9697		613-957-8412	613-957-3489

**Comments:**

RE: FEDERAL REPUBLIC OF GERMANY V. KARLHEINZ SCHREIBER

Please refer to attached correspondence.

Thank you,

### SECURITY INSTRUCTIONS

Unclassified documents only VIA clear transmission.  
Protected information permitted within Justice secure FAX network.

Protected documents?

Yes

 No

### Transmission

Pages (+1):

5

Date:

November 16, 2006

Time

3:18 PM



Department of Justice  
Canada

Ministère de la Justice  
Canada

International Assistance Group  
Federal Prosecution Service  
284 Wellington Street, EMB-2291  
Ottawa, Ontario  
K1A 0T8

Telephone: 613-957-3489  
Facsimile: 613-957-8412

November 16, 2006

**BY FACSIMILE: 613-748-9697**

Karlheinz Schreiber  
7 Bittern Court  
Rockliffe Park  
Ottawa, ON K1L 8K9

Dear Mr. Schreiber:

**Re: Karlheinz SCHREIBER**  
**- Extradition request from the Federal Republic of Germany**  
**- Second Supplemental Summary of Case and Submissions on Reconsideration**

I am attaching a copy of the second supplemental summary prepared for the Minister in relation to your request for reconsideration of the previous Justice Minister's decision on the issue of surrender. This summary contains an outline of your submissions contained in your letter dated October 25, 2006 and your three binders of attachments.

Please note that your submissions and attachments, in their entirety, will be put before the Minister of Justice for his consideration, together with the attached summary.

Yours sincerely,

Jacqueline Palumbo, Counsel  
International Assistance Group  
Federal Prosecution Service

c.c. Edward Greenspan, Q.C., Greenspan, White (fax: 416-366-7994)



Department of Justice  
Canada

Ministère de la Justice  
Canada

Room 2287, 284 Wellington Street  
Ottawa, Ontario

MEMORANDUM / NOTE DE SERVICE

Security Classification -- Côte de sécurité
File number -- Numéro de dossier
Date November 16, 2006
Telephone / FAX -- Téléphone / Télécopieur 613-957-3489 / 613-957-8412

TO / DEST: Minister

FROM / ORIG: Jacqueline Palumbo, Counsel, International Assistance Group  
(via Janet Henchey, General Counsel and Associate Director, International Assistance Group)

SUBJECT / OBJET: **GERMANY v. Karlheinz SCHREIBER**  
- Extradition from Canada to Germany  
- Second Supplemental Summary of Case and Submissions on Reconsideration

Comments/Renarques

**I. PURPOSE OF THIS MEMORANDUM**

This memorandum provides you with a summary of additional submissions sent directly to you by Mr. Karlheinz Schreiber in support of his petition that you reconsider your predecessor's decision to surrender him to Germany. His further submissions are contained in a letter dated October 25, 2006, together with three binders of attachments. All of these materials are appended in their entirety to this memorandum.<sup>1</sup>

Please note that by letter dated November 15, 2006, counsel for Mr. Schreiber advised the International Assistance Group that Mr. Schreiber's additional submissions do not form part of the request for reconsideration submitted on Mr. Schreiber's behalf by his counsel on May 17 and August 10, 2006.<sup>2</sup>

**II. SUMMARY OF SUBMISSIONS**

In his letter to you dated October 25, 2006, Mr. Schreiber writes:

<sup>1</sup> Appendix A: Submissions from Mr. K. Schreiber dated October 25, 2006, including three binders of attachments.

<sup>2</sup> Appendix B: Letter dated November 15, 2006 from Mr. Edward Greenspan to Jacqueline Palumbo, International Assistance Group.

Do not write in this space / Ne pas écrire dans cet espace

*Since your decision in my case is of a highly important political nature in Canada and Germany, I feel strongly that I have an obligation and a right to give to you my views of the story and the scandal.*

He submits that he has been the victim of "the biggest 'Political Justice Scandal' in Canadian history with international political implications". He blames the former Liberal governments and the so-called "Liberal bureaucracy" (which he also describes as "the Liberal Underground Government of Canada") for this "scandal" and, further, he submits that one of the ways in which they have perpetuated this scandal is by delaying and thwarting Mr. Schreiber's outstanding lawsuit against the former Attorney General of Canada, Mr. Allan Rock, in the Alberta Queen's Bench. In this regard, he writes:

*My lawsuit against the Liberal Attorney General of Canada is the only legal route besides a public inquiry to bring the "Political Justice Scandal" in a Canadian court to light. This is why my enemies try everything to stop my actions. Their greatest wish is to have me extradited to Germany, hoping that I will disclose matters of interest to them during a trial in court and at the same time bring the lawsuit to an end in Edmonton.*

Mr. Schreiber underscores the following actions, amongst others, as supporting his allegation of a "political vendetta" carried out against himself and Brian Mulroney by the former Liberal governments and the so-called "Liberal Underground Government of Canada":

1. During the "Airbus affair", two "senior officers" persuaded author Stevie Cameron to give evidence of alleged fraud against Mr. Schreiber in return for "anonymity and insider information" which she then used in her books attacking Mr. Schreiber. He states that these books "*created public support for the RCMP and the Liberal government concerning the political vendetta...*";
2. Millions of taxpayer dollars have been spent in support of an RCMP investigation against Mr. Schreiber that has resulted in no charges;
3. Persons named in the confidential Letter of Request to Switzerland were allegedly disclosed by an RCMP officer to Stevie Cameron who published this insider information in her books. The RCMP officer was later the subject of an RCMP disciplinary hearing;
4. The RCMP struck a deal with the RCMP officer who allegedly disclosed the confidential information to Ms. Cameron and this transaction occurred after the Superior Court of Justice ruled that the RCMP's disciplinary hearings

- 3 -

were unconstitutional insofar as they were held in private. In this regard, Mr. Schreiber is suggesting that the RCMP entered into the said arrangement in order to avoid a public hearing of the matter;

5. Then Solicitor General Herb Gray and then Minister of Justice Allan Rock made alleged misrepresentations to the public regarding the unauthorized disclosure of the names of persons who were the subjects of Canada's Letter of Request to Switzerland;
6. In April 1998, the RCMP advised the German authorities that Canada was also interested in arresting Mr. Schreiber but they had no legal grounds on which to charge him;
7. In September and October of 1999, officials with the International Assistance Group attended in Germany to assist the German prosecutors in preparing their Record of the Case in support of their extradition request.

In particular, Mr. Schreiber targets the Department of Justice as a whole, the International Assistance Group and the RCMP as allegedly taking steps to thwart his lawsuit "through delay, detention or extradition", ultimately to conceal from the public the harm that has been caused to Mr. Mulroney, Mr. Schreiber and their respective families. He also states that he has witnessed first-hand the "Liberal Underground Government's" attempts to "frustrate the policies of the legitimately-elected Conservative [Mulroney] government of Canada" when he was the Chairman of Thyssen-Bearhead Industries in 1985. In relation to this submission, he states the following:

*Thyssen, the Canadian soldiers, the people of Nova Scotia, Quebec and I have been misused and betrayed after Thyssen spent more than \$60 Million on the project for peacekeeping and environment -- protection.*

Mr. Schreiber goes on to describe himself as "a Conservative on an international level" who has made a significant contribution to this country by bringing jobs and considerable funds into Canada. He takes the position that a Conservative Minister of Justice is more likely to review his case from an impartial point of view, but he is concerned that, you will be "shielded" from the information he is attempting to put before you in this matter by those persons who are the subjects of his lawsuit.

He also believes that the current Conservative government is unaware of his civil action in Alberta since officials of the Department of Justice have recently sought the production of records concerning his business and any payments he may have made to Mr. Mulroney. Moreover, they are seeking an order to set aside the examination of Allan Rock in this matter. Mr. Schreiber views these

actions as inconsistent with Prime Minister Harper's position that he would "clean up the Government in Ottawa". He also wonders "*how you will ever get to know what is going on if you have to rely on the advice of the IAG who are the enemies of the Canadian Conservatives in this case since 1995.*"

Mr. Schreiber goes on to criticize your predecessor's decision to surrender him to Germany and suggests that your predecessor was either implicated in concealing the so-called "Political Justice Scandal" or "was totally under the control of the IAG and ignorant" when he ordered Mr. Schreiber's surrender. Moreover, he condemns Canada's practice regarding the extradition of its nationals, particularly in cases where there is no reciprocity. In this regard, he argues that your predecessor was aware that Germany would "never extradite one of its Nationals to Canada" but, nevertheless, proceeded to order his surrender. Regarding the negotiation of extradition treaties which do not involve reciprocity, Mr. Schreiber takes the view that the Canadian government misled the Canadian House of Commons when these treaties were ratified since, based on his review of Canada's treaties, reciprocity is "the most elementary common basis of each Treaty".

Finally, Mr. Schreiber appeals to you to "clean up...the 'Airbus' affair and the 'Political Justice Scandal'" by personally exercising your jurisdiction on the issue of his surrender to Germany. He asks that you reconsider his case with a view to exposing "*the biggest 'Political Justice Scandal' in Canadian history and to bring to an end the nightmare of this case for my family and me.*"

Prepared by:

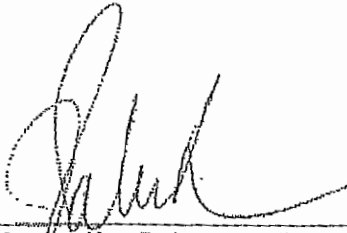
  
\_\_\_\_\_  
Jacqueline Palumbo, Counsel  
International Assistance Group

Reviewed by:

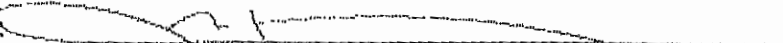
  
\_\_\_\_\_  
Janet Hedehey, General Counsel and Associate Director  
International Assistance Group



Department of Justice / Ministère de la Justice  
Canada

## FACSIMILE TRANSMISSION TRANSMISSION PAR TÉLÉCOPIEUR

SEND TO / ENVOYER À		FROM / DE	
Name / Nom: Karlheinz Schreiber		Name / Nom: Jean-Michael Gabrario, Legal Assistant for Jacqueline Palumbo	
Address / Adresse:  7 Bittern Court Rockliffe Park Ottawa, Ontario K1L 8K9		Address / Adresse:  Justice Canada International Assistance Group 284 Wellington Street Suite 2288 Ottawa, Ontario K1A 0H8	
Fax # / No du télécopieur: 613-748-9697	Tel. No. / No du Tél:	Fax # / No du télécopieur: 613-957-8412	Tel. No. / No du Tél: 613-946-0314

**Comments / Commentaires:**

Re: Karlheinz Schreiber

- Extradition request from the Federal Republic of Germany
- Request for Reconsideration of Minister's Surrender Decision

### SECURITY INSTRUCTIONS / INSTRUCTIONS SÉCURITÉ

Unclassified documents only VIA clear transmission.  
Protected information permitted within Justice secure FAX network.

Documents non cotés à transmettre sans protection.  
Renseignements protégés par le réseau des télécopieurs protégés de la Justice.

Protected documents?  
Documents protégés?

Yes  
Oui

No  
Non

### Transmission

Pages (including cover sheet)  2	Date:  14/11/2006	Time:  1:45 PM
--	-------------------------	----------------------



Department of Justice  
Canada

Ministère de la Justice  
Canada

International Assistance Group  
Federal Prosecution Service  
284 Wellington Street, RMB-2291  
Ottawa, Ontario  
K1A 0H8

Telephone: 613-957-3489  
Facsimile: 613-957-8412

November 14, 2006

**BY FACSIMILE: 613-748-9697**

Karlheinz Schreiber  
7 Bittern Court  
Rockliffe Park  
Ottawa, ON K1L 8K9

Dear Mr. Schreiber:

**Re: Karlheinz SCHREIBER**  
- Extradition request from the Federal Republic of Germany  
- Request for Reconsideration of Minister's Surrender Decision

I am writing to acknowledge receipt of your further submissions to the Minister of Justice in the above matter. Your letter dated October 25, 2006 was received by the Minister's Office on November 1, 2006 and your attachments were received by the Minister's Office on October 30, 2006.

Yours sincerely,

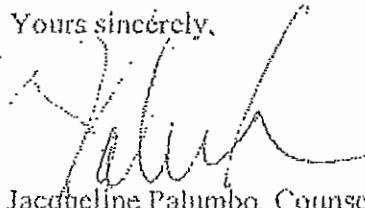

Jacqueline Palumbo, Counsel  
International Assistance Group  
Federal Prosecution Service

c.c. Edward Greenspan, Q.C., Greenspan, White (fax: 416-366-7994)





Royal Canadian  
Mounted Police

Gendarmerie royale  
du Canada

Security Classification/Designation  
Classification/désignation sécuritaire

Protected A

Professional Standards Unit  
Coventry Square Bldg, Room 5-D14  
295, Coventry Rd.  
Ottawa, Ontario K1A 0R2

Mr. Karlheinz Schreiber  
7 Bittern Ct, Rockliffe Park  
Ottawa, Ontario  
K1L 8K9

Your File - Votre référence

Our File - Notre référence

HQVII061401293

Date

January 16, 2007

Object **Public Complaint Against Commissioner Zaccardelli, Supt. Mathews, and**  
Sujet **Insp. Brettschneider.**

Mr. Schreiber,

This is further to our correspondence of November 28, 2006.

I presently wish to inform you that since our last correspondence, Sgt. Paul Ingram has been reviewing the file in relation to your complaint. The investigator would like to meet with you at your earliest convenience to discuss the complaint process and to seek some clarification with regards to the specifics of your complaint. Sergeant Ingram can be contacted at (613)993-8284 in order to schedule an appointment.

You will be receiving further correspondence within the next thirty days to inform you of the status of this file in accordance with the *Royal Canadian Mounted Police Act*.

Yours truly,

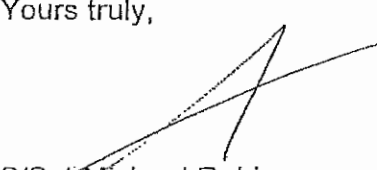

S/Sgt Michael Robineau  
NCO i/c Professional Standards Unit

cc Commissioner Zaccardelli  
Supt. Allan Mathews  
Insp. Rainer Brettschneider

Canada

RCMP GRC 2823 (2002-11) WPT

Page 1 of/de 1

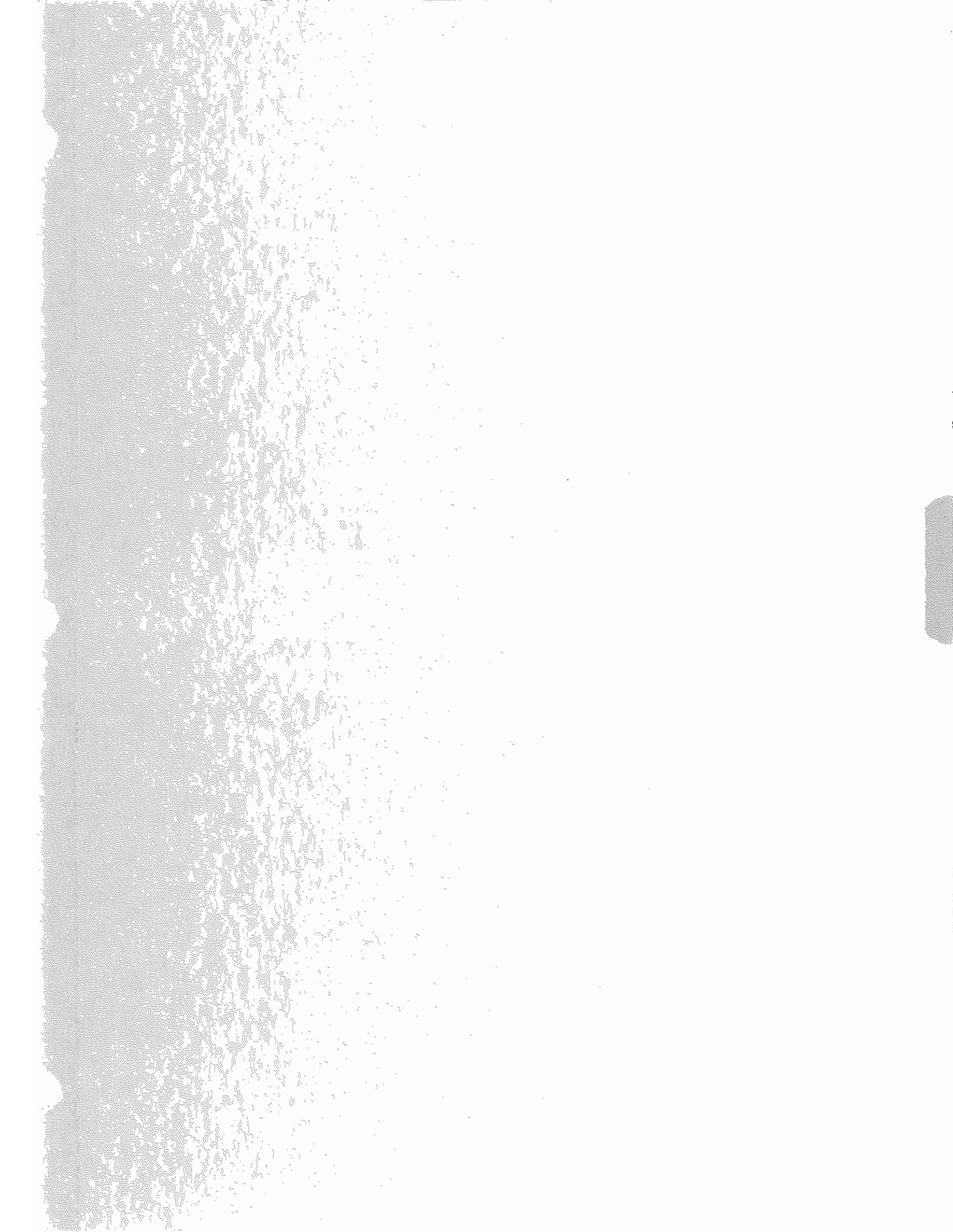

0.

KARLHEINZ SCHREIBER

7 BITTERN COURT, ROCKCLIFFE PARK  
OTTAWA, CANADA K1L 8K9

TELEPHONE 613 748 7330  
FACSIMILE 613 748 9697  
schreiberbarbel@aol.com

The Right Hon. Brian Mulroney, P.C., LL .D.  
47 Forden Crescent

Westmount, Quebec  
H3Y 2Y5

Ottawa, January 29, 2007

Dear Brian,

I refer to my letter January 19, 2006 concerning the decision of The Hon. Vic Toews, P.C. M.P. then the Minister of Justice and Attorney General of Canada to support his predecessor The Hon. Irwin Cotler by denying the "Airbus" vendetta against you and your friends and the existence of the "Political Justice Scandal".

**This case is much worth and much more dangerous than the Maher Arar case.**

Imagine, a Liberal Minister of Justice initiates a political vendetta against a retired Conservative Prime Minister, his friends and the Conservative Party with the involvement of the officials of the Department of Justice, the RCMP, confidential informants and complainants, undercover agents from foreign agencies, journalists and foreign informants with criminal records.

Officials from the Department of Justice and the RCMP participate in an international political conspiracy, traveling during 12 years on taxpayer's money all over the world even violating the sovereignty of foreign countries. No confirmation concerning their allegations of fraud and bribe was found.

A victim of the vendetta files a lawsuit against the Minister of Justice and the Attorney General of Canada.

The vendetta caused an extradition case against the victim. The officials from the Department of Justice and the RCMP are trying to conceal the vendetta and the abuse of power and committed crimes through extradition or detention.

**I always thought that events like this belong to the political behavior in countries with totalitarian Governments.**

Since February 2006 Canada has a Conservative Government. The victim informed the Prime Minister, the Minister of Justice, the Minister of Foreign Affairs, the Minister of Public Safety and others, including you, about the ongoing vendetta.

On December 1, 2006 the Conservative Minister of Justice confirmed his predecessor's decision to extradite the victim to Germany required through Extradition -- Treaty obligations. Every Minister involved and you know that this is a huge lie.

THE CANADIAN - GERMAN EXTRADITION TREATY

ARTICLE V: EXTRADITION OF NATIONALS

**(1) NEITHER OF THE CONTRACTING PARTIES SHALL BE BOUND TO EXTRADITE ITS OWN NATIONALS .**

Germany will never extradite one of its Nationals to Canada. The German Constitution, Article 16 (2) will not allow the extradition of its Nationals.

Dear Brian, can you please tell me why the Conservative Minister of Justice wants the Canadian National Karlheinz Schreiber, the victim, out of the country and help to conceal the biggest "Political Justice Scandal" in Canadian history contrary to the normal political interest of the Conservative Government.

**I do not believe that the Hon. Vic Toews, then the Minister of Justice and Attorney General of Canada, made this decision on his own. What is the political interest of the Conservative Government and the Prime Minister in this case and what are the benefits? Is there a serious concern about the possible result of an inquiry?**

Unfortunately, you did not respond to my letter as requested and it appears to me that you have no desire to bring any support to my request for a public inquiry which could bring the insanity to an end.

All my personal problems began with Stevie Camerons book "ON THE TAKE" and Allan Rock's political witch-hunt with the RCMP against you.

Since 1996 I am fighting to bring the truth to light through my lawsuit against the Attorney General of Canada. I never received any support from you despite the fact that I provided support at your request since the late 70s.

From 1985 until 1993 I had confidence in you and your statements concerning the Thyssen Bear Head project. You always told me to hang on and that the Thyssen project would go ahead as promised when the company was asked to come to Canada and provide jobs to the people in Nova Scotia.

During the year 2001 I could read in Stevie Cameron's book "The last Amigo" on page 260 that Norman Spector told RCMP officers : Prime Minister Brian Mulroney killed the Thyssen project in 1990 or 1991. Paul Tellier and Bob Fowler were looking after the business interests of General Motors London Ontario.

This was some time after Thyssen Bear Head Industries signed agreements concerning the projects with the Federal Government and the Provincial Government of Nova Scotia and Thyssen had paid substantial amounts of Dollars to GCI Frank Moores related to the achievements.

You never told Elmer Mackay or me that you killed the project and I went on working on it to fulfill your promises to bring jobs to the people in Nova Scotia.

During the summer of 1993 when you were looking for financial help, I was there again. When we met on June 23, 1993 at Harrington Lake, you told me that you believe that Kim Campbell will win the next election. You also told me that you would work in your office in Montreal and that the Bear Head project should be moved to the Province of Quebec, where you could be of great help to me. We agreed to work together and I arranged for some funds for you.

Kim Campbell did not win the election, but we met from time to time.

At the beginning of November 1995 I informed you about the letter of request from the Canadian Department of Justice (the IAG) to the Swiss Department of Justice.

Some days later your wife Mila was extremely concerned about you and told me that you are considering committing suicide. I was shocked and spoke to you for quite a while and you may recall that I told Mila to buy a little lead pipe to cure the disease.

I did not understand what your problem was since the Airbus story was a hoax as I told Bob Fife from the Sun. When I look back and consider what all you have done in the meantime I have the suspicion that there must be something else of great concern to you.

When we met in Zuerich, Switzerland on February 2, 1998 at the Hotel Savoy, I left with the impression that you were in good shape.

On October 17, 1999 you asked for an affidavit or assurance from me which confirms that you never received any kind of compensation from me.

At the beginning of October 1999 to my great surprise I learnt that your spokesman Luc Lavoie told Harvey Cashore: "*Karlheinz Schreiber is the biggest fucking liar the world has ever seen. That is what we believe!*"

Believing the story, I got from you through a friend, I filed a lawsuit against the CBC which I had to drop when I got to know the truth and listening to the tapes. The fee: \$ 50.000.

During the Christmas Holydays 1999 I visited Fred Doucet at his home and told him that he should tell you that I would not commit perjury if I would have to testify and that I cannot understand why you don't simply tell the truth. A few days later, when I met with Fred again, he asked me to sign certain agreements concerning our business relationship. I refused to do so.

On January 24, 2000 Mila sent a letter to Baerbel and wrote: "the truth is certainly the best weapon!" She was right. If you would have taken her advice, you might have avoided a lot of trouble for you.

Until now you have to recognize that the Vendetta is not going away by itself.

During the summer of 2006, you again asked for a certain letter from me to be able to support my case, which I have sent to you on July 20, 2006 for your meeting on July 30, 2006.

When I look at the news during the last week and the activities from last year within the Department of Justice, concerning your settlement with the Government, I have a certain idea why your meeting was very important.

To assure that we have the same understanding about my case:

### **The Decision to Surrender**

**The judicial phase of the extradition process is a determination only that the evidence is sufficient to warrant that the person be extradited. The ultimate decision with respect to whether the person will, in fact, be surrendered to the extradition partner is that of the Minister of Justice.**

When you look at my extradition case you have to agree with me that Baerbel's and my life is in the hands of the Minister of Justice and the Prime Minister or the IAG, who can arbitrarily decide since they have no obligation to extradite me to Germany.

**Since the Minister of Justice decided on my surrender he must have a special reason to do so. What is the reason, becomes the most interesting question.**

Dear Brian, I would like to ask you what the reason might be in your opinion, besides this I think it is in your and my best interests that you show up and help me now and bring this insanity to an end. If I am forced to leave Canada this will not end the matter.

Yours sincerely

A handwritten signature in cursive script, appearing to read "Ron Jones".

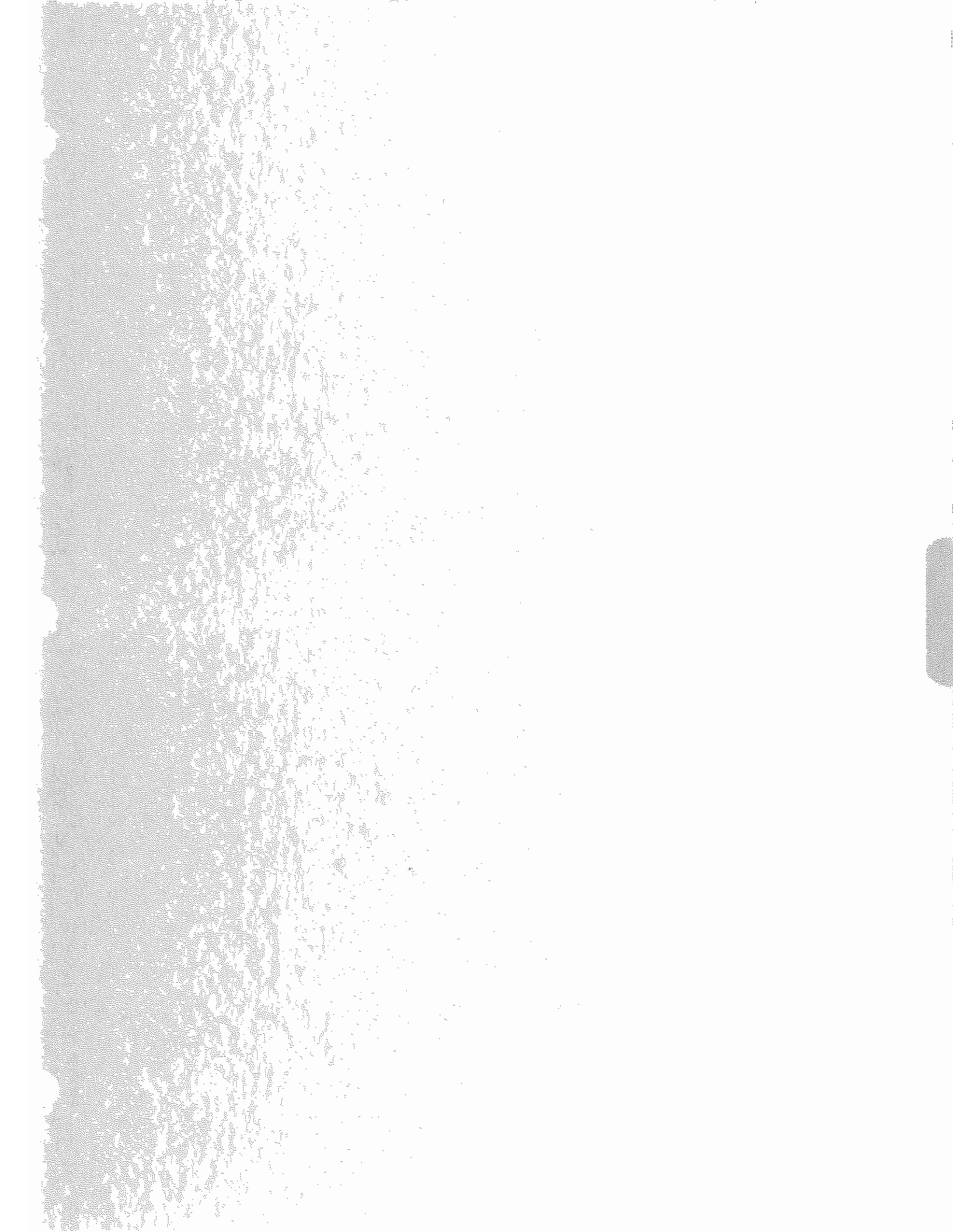



KARLHEINZ SCHREIBER

102 BLOOR STREET WEST, SUITE 511  
TORONTO, ON M5S 1M8

TELEPHONE 416 578 4022  
TELEFAX 416 935 1418  
schreiberbarbel@aol.com

**Private and Confidential**

The Right Hon. Brian Mulroney P.C., LL. D.

47 Forden Crescent  
Westmount, Quebec  
H3Y 2Y5

Oglivy Renault  
Barrister & Solicitors  
1981 McGill College Avenue  
Montreal, Quebec  
H3A 3C1

Att: Brian Mulroney, P.C., LL. D. ( The Right Honourable)

WITHOUT PREJUDICE

Toronto, February 20, 2007

**RE: Return of \$ 300.000,00 cash payments plus 5% interest from January 1,1995  
until February 28, 2005 \$ 185.000,00 (Total amount \$ 485.000,00)**

Dear Brian,

Unfortunately, nothing came of our plans as discussed during our meetings in 1993 and 1994. Meanwhile events have unfolded that brought us considerable public embarrassment, media attention and court battles, some settled, others still pending.

When we last spoke on the occasion of the dinner in honor of Mr. Peter Munk on May 23, 2000 we agreed that we would meet again after your return from Florida. But we never met. To date the only messages I received were underhanded comments as early as 1999 from Luc Lavoie, introduction by Michel Cogger to Vahe Minasian on

March 23, 2001 and more recently the publication of William Kaplan's book "The Secret Trial" and his interviews in the Globe and Mail quoting from Pat MacAdam's letter dated July 19, 2004.

The fact is you did nothing. You even ignored my letters and refused to meet with Elmer and Mike to discuss the Pasta obesity fighting program for children.

There is no foreseeable business that would warrant a payment of \$ 300.000.

Therefore, I demand the return of the funds in the amount of \$ 485.000 (fourhundeightyfivethousand) no later than March 5, 2007, after which I will commence a civil lawsuit against you immediately.

Yours truly



KARLHEINZ SCHREIBER

7 BITTERN COURT, ROCKCLIFFE PARK  
OTTAWA, CANADA K1L 8K9

TELEPHONE 613 748 7330  
TELEFAX 613 748 9697  
schreiberbarbel@aol.com

Per Fax [1] 514 4369 9393

The Right Hon. Brian Mulroney, P.C., LL .D.  
47 Forden Crescent

Westmount, Quebec  
H3Y 2Y5

Ottawa, March 29, 2007

Dear Brian,

I strongly recommend that you request a Public Inquiry concerning the "Airbus" Affair, the "Political Vendetta" and the "Political Justice Scandal" related to The Right Hon. Brian Mulroney, The Hon. Frank Moores, Garry Ouellet Q.C. and Karlheinz Schreiber before April 2, 2007.

Yours truly,

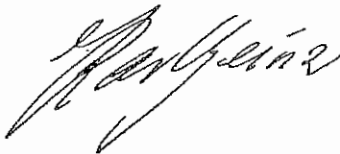



KARLHEINZ SCHREIBER

7 BITTERN COURT, ROCKCLIFFE PARK  
OTTAWA, CANADA K1L 8K9

TELEPHONE 613 748 7330  
TELEFAX 613 748 9697  
schreiberbarbel@aol.com

The Right Hon. Brian Mulroney, P.C., LL .D.  
47 Forden Crescent

Per Fax (1) 514 369 9393

Westmount, Quebec  
H3Y 2Y5

Ottawa, April 10, 2007

**Subject: "Bomb kills 6 Canadian soldiers in Afghanistan"**

Dear Brian,

I take the liberty to send you a copy of the CBC News April, 8, 2007:  
"Bomb kills 6 Canadian Soldiers in Afghanistan",

an article of canada.com: "Canada to lease tanks for Afghanistan" April 3, 2007,

a copy of my letter March 16, 1993 to you,

an article: "Thyssen Henschel's TH 495 MICV"(The Bear Head MRCV)

and information on the new German: "Puma infantry fighting vehicles".

Finely, 14 years after I send my letter to you, the Canadian Government made the right decision to protect Canadian soldiers and asked the German Government for the lease of the best tanks.

How do you feel today when you read my letter from March 16, 1993 and you must think of all the poor soldiers who had to die in the meantime?

Yours truly,

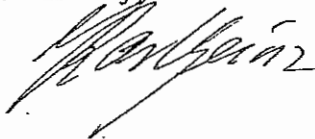

# Karlheinz Schreiber

Suite 908, 350 Sparks St., Ottawa, Ont. K1R 7S8  
Telephone: (613) 563-3321 Fax: (613) 563-7648

PERSONAL AND CONFIDENTIAL

1/4

March 16, 1993

The Right Honourable  
Brian Mulroney  
Prime Minister of Canada  
Langevin Block  
80 Wellington Street  
Ottawa, Ont.  
K1A 0A2

Dear Prime Minister:

For more than thirteen years I have had the privilege to call you my friend. In all of those years you always gave me the feeling of confidence that I could count on you, as you know you always could with me.

For nearly thirty years, I worked closely with my friend Franz-Josef Strauss; and it was not always easy to confront him with realities that he did not like. Living with the understanding that we shared a certain degree of intelligence we agreed that the greatest treasure between friends is the truth. That includes that true friends are aware that it would never be their intention to embarrass or to influence on unreasonable grounds. Keeping this in mind and looking at the situation in Canada, I have come to the conclusion that the philosophy "wash me but don't make me wet" is not going to work any longer.

If it is your understanding that Kim Campbell is the best choice to be the next Prime Minister

# Karlheinz Schreiber

## PERSONAL AND CONFIDENTIAL

2/4

for Canada, with the capability to solve the enormous problems of the country, then it is my opinion that she should resign as Minister of Defence as soon as possible. The reason I say this is because I believe the pressure and problems she may face with the Ministry may harm her chances. I don't want to deal with the problems she may face with the anti-submarine helicopter, rather I put much more importance on the safety of Canadian soldiers in Yugoslavia and in other peacekeeping missions.

The strong feeling of friendship toward you tells me that I owe you the following report on the situation as I see it:

Today, Lewis Mackenzie (MGen Ret'd) in his first speech after his official retirement from the Canadian Armed Forces spoke out frankly and honestly without editorial control from the Department of National Defence. He spoke about the state of inadequate armoured protection of Canada's armoured personnel carriers, which he experienced first hand. He specifically criticised the cancellation of the Army's requirement known as the Multi Role Combat Vehicle (MRCV) as a primary reason for the inadequacy of equipment for Canada's soldiers who are the ones exposed to the very real and serious risks of peacekeeping.

You may also be aware of the ongoing hearings of the House of Commons Committee on National Defence and Veterans Affairs, where on the 17th of February 1993, during the appearance of Adm. Anderson, Chief of Staff to the Canadian Forces, it was confirmed by his technical assistant, LCol Peter Kenward, that the M-113 and the Grizzly and Cougar (basically all of Canada's Armoured Personnel Carriers) only have protection against 7.62 mm ball ammunition, which leaves them vulnerable to the commonly used 7.62 mm armoured piercing ammunition, and most varieties of machine gun ammunition.

You may already have known of the problems with Canada's armoured vehicles from the CBC's Journal of June 22, 1992 when they interviewed Canadian troops in Yugoslavia who when discussing the state of their armoured personnel carriers told The Journal "the bullets from one of their own guns can go through one of these things like butter and it's all the protection they have".

As far back as May 26, 1987, in testimony to the Senate Committee on National Defence, LGen J.A. Fox, Commander Mobile Command, described the desolate state of Canada's



# Karlheinz Schreiber

PERSONAL AND CONFIDENTIAL

3/4

armoured vehicle fleet in comparison to the vehicles of the Warsaw Pact then and also in comparison to Canada's allies.

The German Ministry of Defence provided us with samples of the aluminum plate of an actual M-113 armoured vehicle which had been fired on and completely pierced by a basic 7.62 mm armoured piercing round. You will recall that I showed you those samples when we met at 7 Rideau Gate together with the Hon. Elmer MacKay. As a reminder of this I enclose a photograph of the pierced aluminum plate (1.75" thick) and the 7.62 ball and armoured piercing ammunition samples. I also informed the Hon. Bill McKnight, then Minister of Defence of this situation, and later did the same with the Hon. Marcel Masse when he was the Minister of Defence as well Mr. Fowler, Deputy Minister of National Defence.

In a letter dated February 10, 1992, Canadian Ambassador Delworth, on behalf of the Minister of National Defence, informed the Ministry of Defence in Germany of the pending Army project known as the MRCV, within which the lead procurement would be the RCV (Reconnaissance Combat Vehicle): "The armoured reconnaissance vehicle, RCV, must be equipped with an armour resistant against 30 mm piercing ammunition".

On April 7, 1992 in a Department of National Defence News release, we learned that GM Diesel Division was selected on a sole source basis to produce up to 229 light armoured vehicles "enhanced for the reconnaissance role". Without doubt, this vehicle will be unable to meet the stated armament requirement for resistance to 30 mm armour piercing ammunition and it is unlikely that it will achieve any higher level of protection than the Canadian Army has in the GM vehicles of the same design which they already have.

Finally, I would like to inform you that Norwegian and French Forces refused to send their soldiers to Yugoslavia with protection less than 12.7 mm (50 calibre) armour piercing. Canada is present especially in Yugoslavia now with nowhere near that level of protection. The constant threat is that Canadian peacekeepers in their outdated armoured personnel carriers could be killed by crossfire of rifles which use basic 7.62 armour piercing ammunition prevalent in the Yugoslav conflict.

With this situation, I cannot comprehend why Canadian DND will not accept a loan of

# Karlheinz Schreiber

PERSONAL AND CONFIDENTIAL

4/4

appropriately protected equipment from their German ally especially when at present the German Forces cannot participate in the peacekeeping missions in Yugoslavia. Nevertheless, the American and British Forces were not too proud to accept such a loan from Germany of the NBC Fox reconnaissance vehicles during the Gulf crisis. I was heavily involved in the arrangements to supply those vehicles to the Americans, within 48 hours of their request.

I have no doubt that you share my real concerns on the situation of our Canadian soldiers in Yugoslavia. The question is no problem for those who are not involved or are not aware of the risk Canadian soldiers face, but we are and we know, therefore, I feel guilty that I may not have done all I could to protect those soldiers who take such risks for the preservation of peace. Let's pray that Canadian soldiers are not killed as a result of their poor equipment, because the blame for their death will rest on the inaction of the Canadian Government in not providing them with adequate equipment. Almost certainly that blame will fall on the shoulders of Mrs. Campbell, and she has had virtually no involvement in allowing this situation to go unaddressed.

If you feel that I could be of any assistance to help solve the problem, please feel free to call on me at any time.

Best regards,



Karlheinz Schreiber

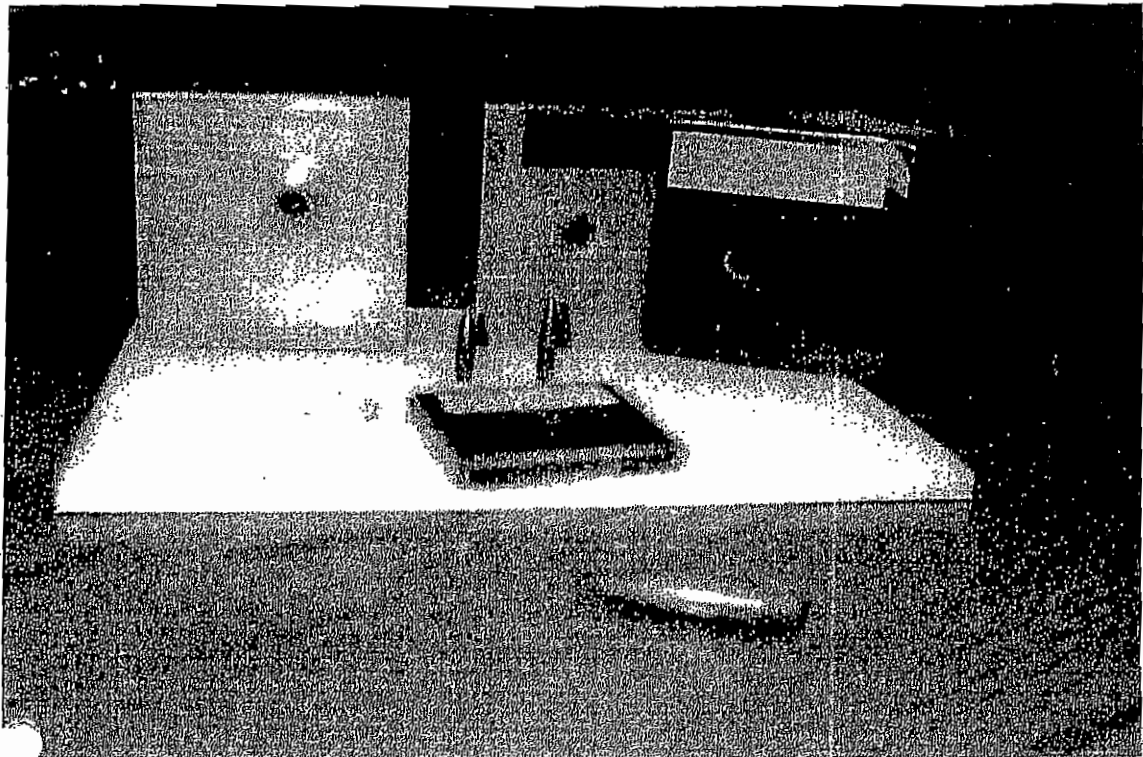
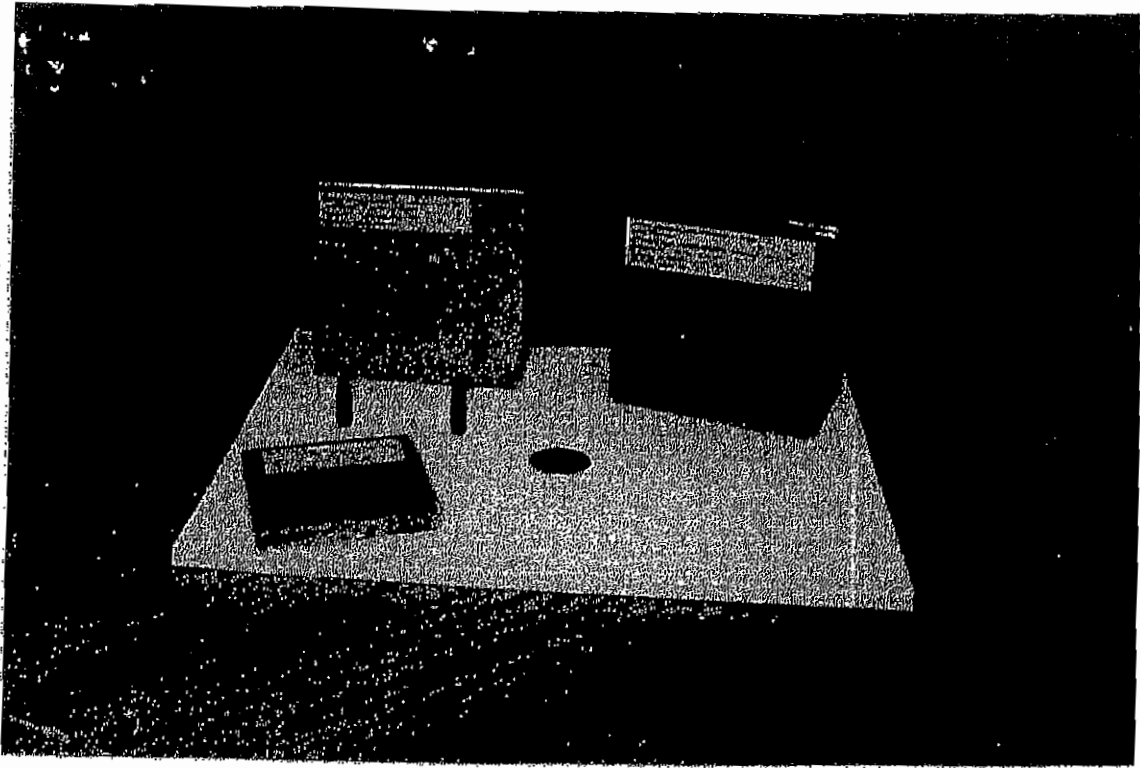



**TH 495**

Date: 08. May 1992

No.

**Figur 2: Comparison of Projectiles**

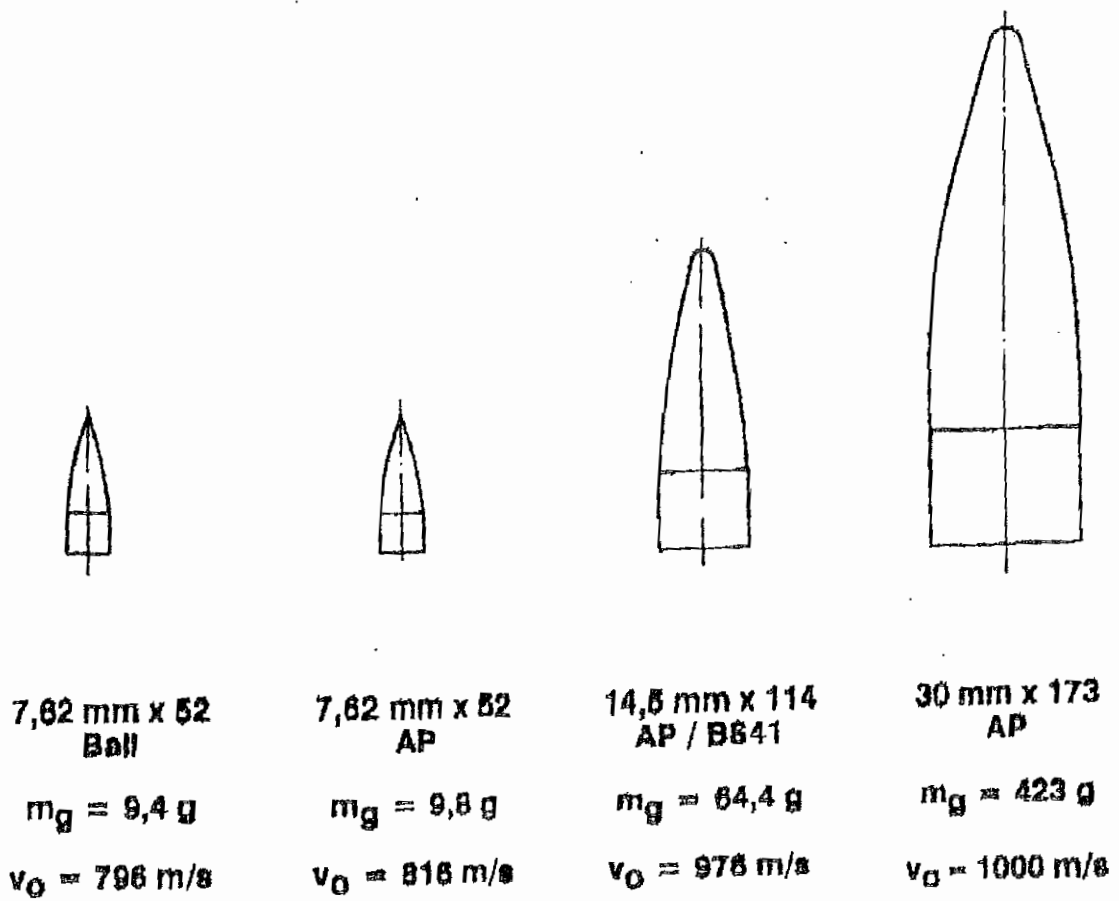

# Bomb kills 6 Canadian soldiers in Afghanistan

Last Updated: Sunday, April 8, 2007 | 6:46 PM ET

[CBC News](#)

A roadside bomb killed six soldiers and injured two others in an armoured vehicle west of Kandahar City on Sunday, resulting in the worst single-day loss of life for Canadian Forces in Afghanistan, military officials said.

The LAV III hit an "improvised explosive device" around 1:30 p.m. local time, Col. Mike Cessford, deputy commander of Task Force Afghanistan, told reporters at Kandahar air base.

Earlier, Prime Minister Stephen Harper confirmed the deaths as he spoke to a shocked crowd of dignitaries and veterans in Lille, France, where he was attending a dinner to mark the 90th anniversary of the Battle of Vimy Ridge.

"Sadly today has been a difficult day in Afghanistan," Harper said. "We've learned that an incident has claimed the lives of six Canadian soldiers and injured a number of others."

"Our hearts ache for them and their families, and I know as we gather here on Easter Sunday our thoughts and prayers are with them," the prime minister said.

Harper's announcement was met with an audible gasp from the crowd.

The troops were serving with NATO's International Security Assistance Force (ISAF) in Helmand province, where the multinational force recently launched a major offensive against the Taliban.

No names or hometowns of the soldiers involved have been released.

In another area of the south, one NATO soldier was killed and another injured earlier Sunday by a similar type of bomb, a NATO spokeswoman said. The location was not disclosed.

## One soldier in serious condition

Cessford said 10 soldiers were riding in the vehicle when it struck the explosive. Four Canadian soldiers were flown to the hospital at Kandahar air base.

One is listed in serious condition with non-life-threatening injuries and will likely be taken to the U.S. military hospital in Landstuhl, Germany, Cessford said. A second soldier suffered minor injuries and the other two were not hurt.

"We lost six of our best, and really, we are thinking of the families as much as anyone," Cessford said,



Col. Mike Cessford, deputy commander of Task Force Afghanistan, announced in Kandahar Sunday that six Canadian soldiers were killed in a roadside bomb explosion and two soldiers were wounded, one seriously.  
(John Cotter/Canadian Press)

adding that despite the tragic incident, the soldiers stationed at Kandahar remain committed to the mission.

"We are focused on rebuilding Afghanistan and doing the right thing by those kids who wave at us every day as we drive down the roads here," Cessford said.

Maj.-Gen. Ton van Loon, the ISAF chief of Regional Command South, said "the hearts of his soldiers" go out to the victims' families and their country.

### **Reaction to soldier deaths**

In Toronto, NDP Leader Jack Layton told CBC News, "it's a devastating blow."

He said that there will be doubt about the mission in Afghanistan, which was recently extended by the government, but Sunday was a day to pray for and reflect on those who sacrificed their lives for the country.

Since 2002, 51 Canadian soldiers and a diplomat have been killed in Afghanistan, where Canada has more than 2,000 troops, with the majority in the southern province of Kandahar.

The main thrust of the offensive in Helmand province is being handled by British and American troops, with Canadian soldiers offering backup and security. About 5,000 soldiers in all are engaging the Taliban, including elements of Afghanistan's army.

In February, the Taliban said it has 6,000 fighters ready for a spring offensive and could dramatically increase that number if necessary.

Al-Jazeera reported at the time that Taliban leader Mullah Dadallah had recruited 500 suicide bombers for the campaign.

## Canada to lease new tanks for Afghanistan

**David Pugliese and Jonathan Fowlie**

CanWest News Service

Tuesday, April 03, 2007

OTTAWA — The federal government is proceeding with the lease of some of the most modern Leopard tanks on the market as it boosts its equipment in Afghanistan.

Defence sources told CanWest News Service that Ottawa will lease 20 A6M tanks from Germany. The tanks, which have improved protection against landmines and other enemy weapons, could be shipped to Afghanistan direct from Germany, sources said.

In addition, the new Leopards are air conditioned so they could operate in Afghanistan's stifling summer heat. Canada's older Leopard tanks now in Kandahar do not have air conditioning and there have been concerns the heat could limit their usefulness on the battlefield.

Temperatures inside the vehicles could soar beyond 60 C.

The lease was approved last week by the cabinet priorities and planning committee.

Defence Minister Gordon O'Connor wasn't releasing details about the Leopard tank lease Tuesday, but he did say the tanks were a necessity for the Afghan mission.

"Our experience in Afghanistan has proven we need main battle tanks," he said. "It's really to offer security to our soldiers."

O'Connor suggested the decrease in the number of Canadian casualties in the last six months was due to more use of heavier armoured vehicles, including the tanks.

Over the last year there has been a major about-face in the Canadian military's view of the usefulness of tanks. The Leopards were originally scheduled to be destroyed or sold off, but the army put a halt to that program.

It sent the Leopards to Afghanistan in the fall and began its search for newer tanks to purchase or lease.

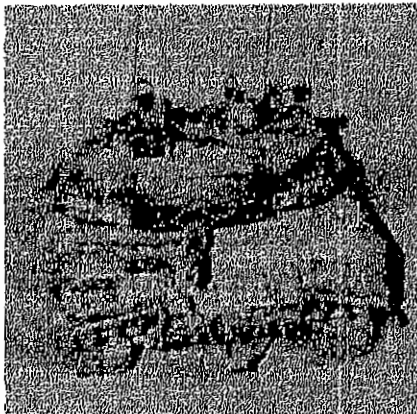

CREDIT: Doug Schmidt/Windsor Star  
A Leopard tank of the Edmonton-based Lord Strathcona's Horse, attached to ISTAR squadron in southern Afghanistan, returns to a Canadian Forces mountain base after assisting a patrol on the lookout for Taliban insurgents.

© CanWest News Service 2007

CLIPPING WINDOW

Copyright © 2007 CanWest Interactive, a division of CanWest MediaWorks Publications, Inc. All rights reserved.

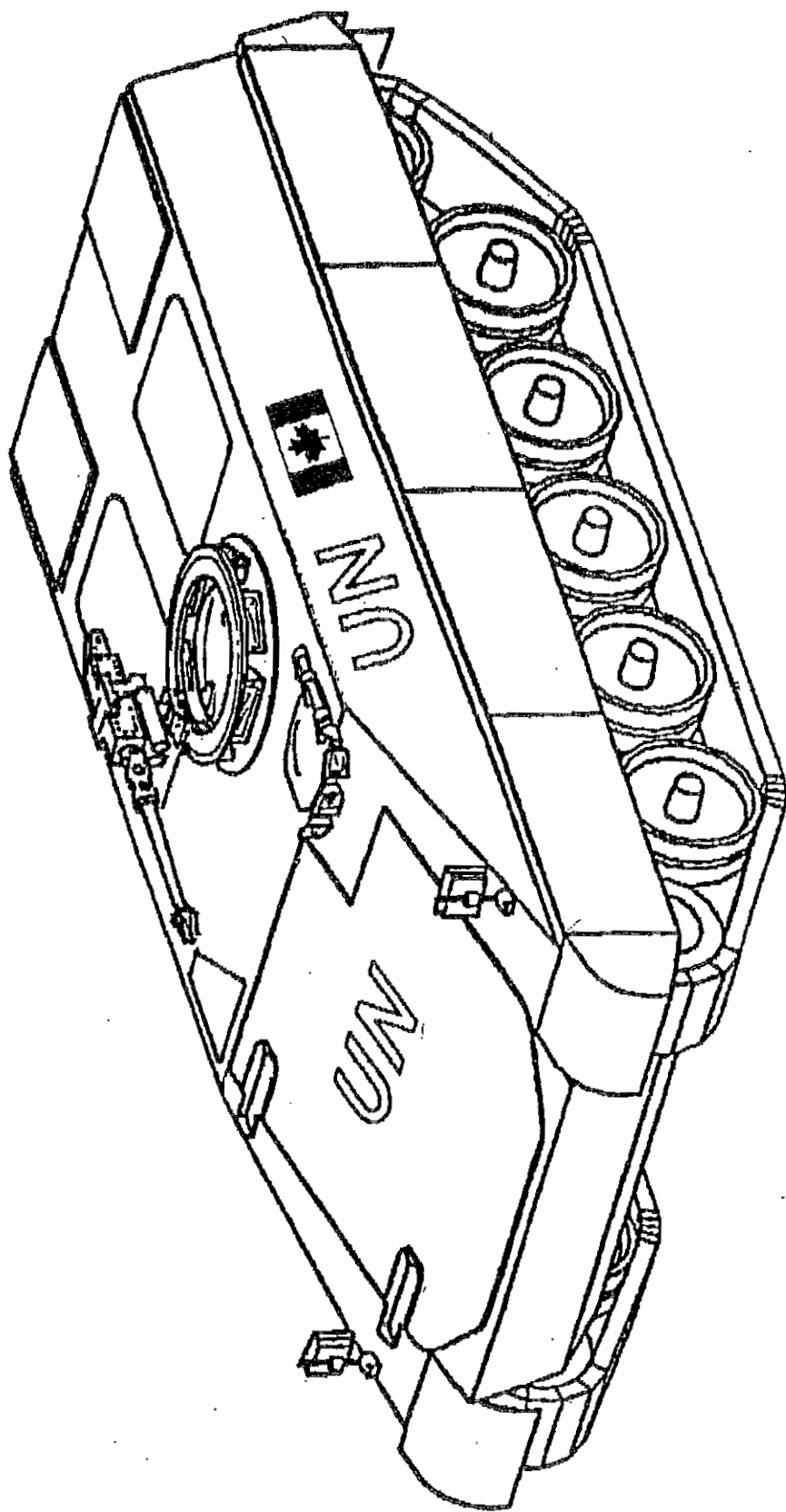

THYSSEN BEAR HEAD INDUSTRIES LTD.



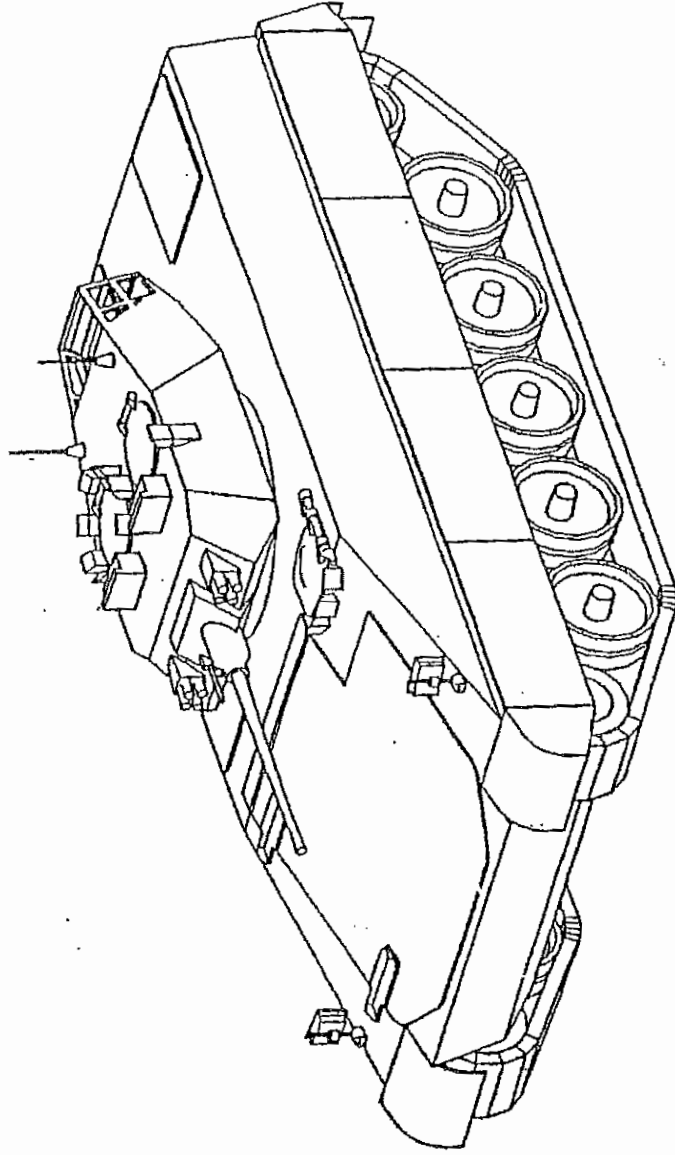

TH 495

WITH TURRET LAV 25 MM.

 BEAR HEAD INDUSTRIES LTD.  
THYSSEN HENSCHEL

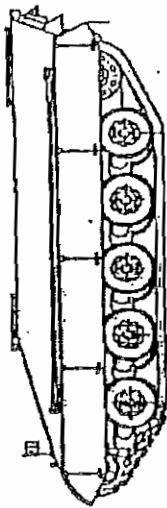

T H 4 9 5

CARRIER

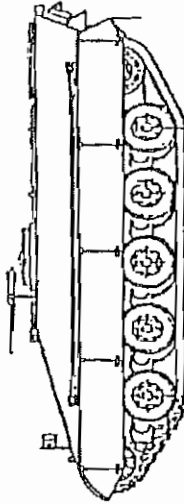

T H 4 9 5

INFANTRY-VEHICLE, with MG 7.62 pin-mounted

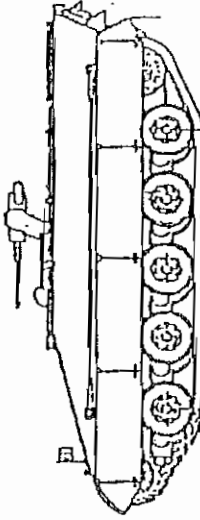

T H 4 9 5

INFANTRY-VEHICLE, with MG 12.7 Cupola

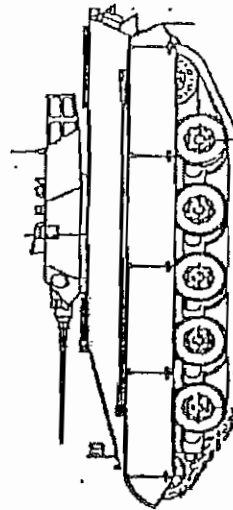

T H 4 9 5

INFANTRY-FIGHTING-VEHICLE, with main gun 25 mm

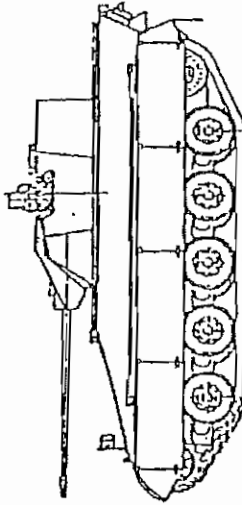

T H 4 9 5

INFANTRY-FIGHTING-VEHICLE, with main gun 35/50 mm

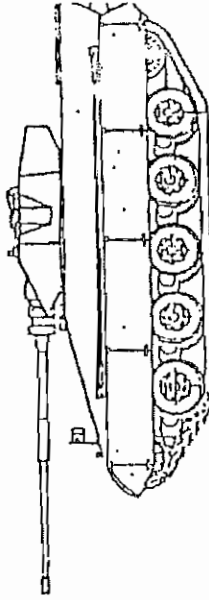

T H 4 9 5

INFANTRY-FIGHTING-VEHICLE, with BK 60 mm

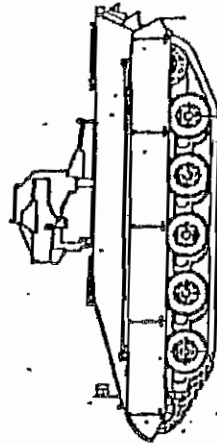

T H 4 9 5

INFANTRY-VEHICLE, with armoured launching turret for the TOW Missile System

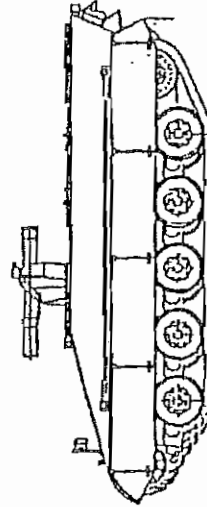

T H 4 9 5

TANK HUNTER, with TOW-launcher

 BEAR HEAD INDUSTRIES LTD.  
THYSSER HEINRICH

Those responsible for weapons procurement in Germany were surprised by the rapid changes following the demise of the Soviet Union. For more than three decades, Germany's efforts concentrated on the development of high-endurance, versatile multi-purpose armoured fighting vehicles (AFVs).

These became bigger and increasingly complex, optimized for the defense of a Central Europe threatened by Warsaw Pact forces superior in both general combat and anti-tank capabilities. This resulted in clumsy, heavy tanks and infantry fighting vehicles exceeding 50 and 40t respectively.

Given recent emphasis upon UN-controlled crisis management, the unified German forces realized that they lacked an effective combat vehicle suitable for strategic movement. Even the 17t, 2.98m-wide M6 Fuchs is not air-transportable except by Starlifter or Galaxy aircraft. Faced with the possibility of significant political policy changes concerning Bundeswehr involvement with European rapid reaction forces, procurement planning has been suspended until a decision is made. Thus, despite limited funding, it was logical that the major German defense manufacturers should begin development of light AFVs suitable for crisis-management roles. Examples include the Diehl/Krauss Maffei Puma (as a possible M113 replacement) and the Krupp-MAK CV-90. Another interesting approach is the Thyssen Henschel TH 495, the first prototype of which recently had its roll-out in Kassel.

The first TH 495 prototype was built in a MICV configuration and forms the nucleus of a family of tracked vehicles able to meet all the requirements of an out-of-area mission. One of the main demands was that the vehicle should be transportable by C-130 Hercules. This limited weight to less than 20t, and both width and height to 2.72m. Nevertheless, it was decided to maximize protection by incorporating modular armour panels which could readily be altered to meet a specific threat. Otherwise, the MIVC-version resembles the Marder 2, with the engine at the front, a rear troop-carrying compartment and a central cannon-armed turret to provide a favourable centre of gravity.

Good all-around (including overhead) protection is provided by spaced and/or special armour packages each of which can be removed or fitted by two crewmen within a few minutes. Spare or additional armour-modules could, for example, be transported in a second aircraft together with the crew, fuel, and ammunition to reduce vehicle weight, thereby increasing aircraft range. (In the prototype configuration seen at Kassel - mounting an OTO-Melara T 25 turret - the TH 495 has a combat weight of 26t. Thyssen Henschel pointed out that any other comparable turret can be fitted with the TH 495 according to the user's choice). Without its add-on modules the vehicle is only 2.72m wide. An internal spall-liner, NBC system, fire-suppression system (optional), and

# Thyssen Henschel's TH 495 MICV

by Wolfgang Schneider

explosion-proof fuel tanks also raise crew protection beyond the standard for light armoured fighting vehicles.

The MICV has a crew of three and carries seven in the troop compartment. The driver is on the left of the engine and is provided with three integral periscopes in the single-piece hatch, one of which can be replaced by an image-intensifier for night driving. The commander and gunner sit in the turret. In the spacious rear compartment an infantry section is seated in two rows facing inwards. Up to four soldiers can fire personal weapons from the two roof hatches; the side-hinged rear doors have two weapon-ports. When closed down, the section can view the battlefield on two monitors linked to side-mounted cameras.

Emphasis has been placed upon a low infrared signature which has been achieved by ventilating the gap between the spaced

**Thyssen Henschel seems to have anticipated the shift in German requirements away from heavy armoured vehicles towards more mobile modular designs with its private-venture TH 495 family.**

armour and the hull, as well as by careful layout of the exhaust and engine-cooling systems. Two cooling systems are located at the rear above each sponson; hot gases from the exhaust and cooling system are mixed with cold air in an "IR grating", and then vented downwards from a grill on the rear-right of the

vehicle. The hot spot usually easily visible through a thermal sight is not identifiable from the front. Radar reflection is reduced by a combination of the vehicle's smooth surface and an absorbent coating.

## Mobility

The TH 495's mobility is also good. The prototype is powered by an MTU 183 TE 22, 441kW (600hp) diesel, giving a power-to-weight ratio of more than 17kW/t (23HP/t). The track width of 450mm makes for a ground pressure of 72.7kPa in the MICV configuration and considerably less as an APC. The Th 495 is easily driven thanks to the improved ZF LSG 1500 fully automatic transmission, good ergonomics, and high safety standards. The driver's station, together with all controls and information displays is vertically adjustable. When driving with the hatch open, driver-information is displayed on a panel mounted between hull roof and add-on armour. A digital power supply is fitted; micro-processors control all systems currently fitted, as well as monitoring their

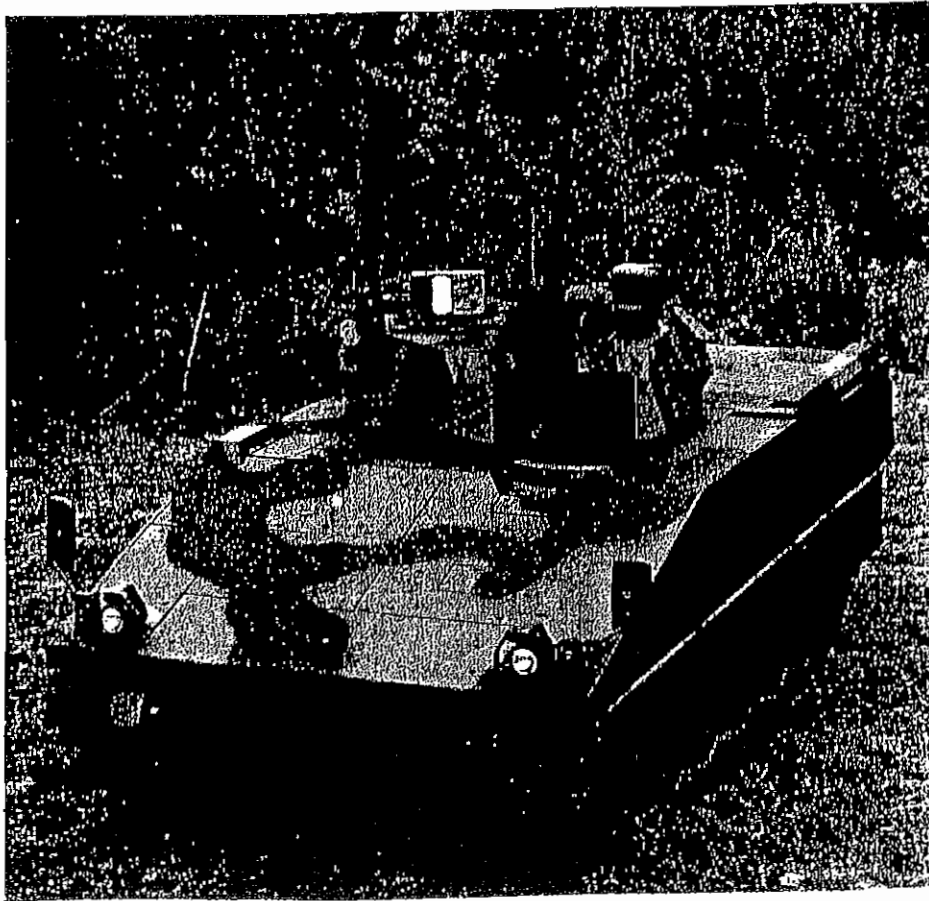

vell  
ex-  
  
y,  
air  
hen  
t a  
ible  
ble  
ced  
oth

The  
TE  
ver-  
W/t  
nr  
a in-  
bly  
ven-  
illy  
ics,  
sta-  
or-  
le.  
ver-  
nel  
ar-

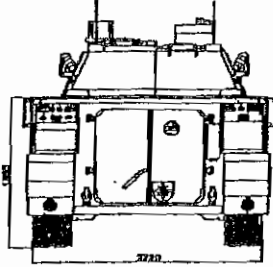
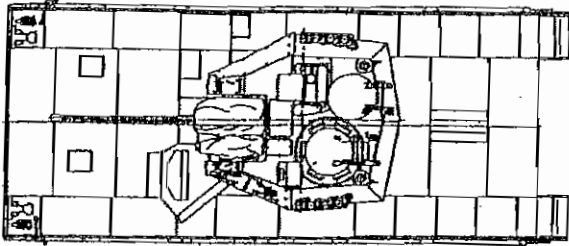
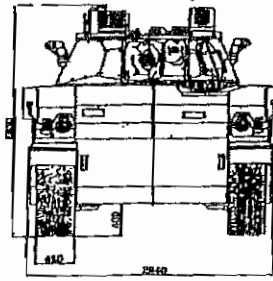
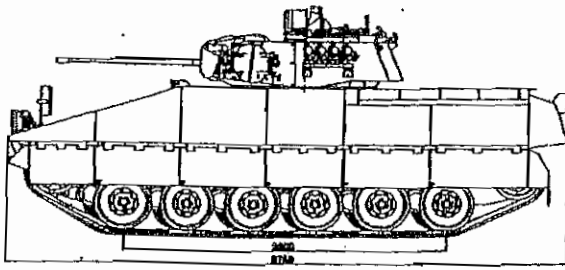

The TH 495 MICV forms the basis of the range; the layout is conventional, and a variety of turrets can be fitted. Spaced armour and exhaust coolers reduce the thermal signature, whilst the smooth hull and special coatings do the same for its radar signature.

operation, reporting faults to a diagnosis system combined with an integrated control system. The vehicle uses subsystems

and components already in series production and proven in non-military vehicles, thereby ensuring a high degree of reliability and reduced maintenance.

### TH 495 armoured vehicle family

Construction is progressing on a second prototype with a hull 780mm shorter, and five instead of six road wheels. Roll-out is

scheduled for February 1993. The main features of the suspension (torsion bars, three return rollers, hydraulic shock absorbers on the two front and rear wheel stations of each side, Diehl double-pin track) remain unchanged. Depending upon vehicle configuration, the weight can be reduced to under 15t. A potentially interesting variant would be an armoured cavalry vehicle fitted with a 90 to 120mm anti-tank gun. The rest of the family is more conventional, comprising:

- TOW-based tank destroyer,
- Stinger anti-aircraft vehicle,
- radar carrier,
- APC,
- armoured ambulance,
- supply carrier,
- maintenance vehicle,
- and a command and communications vehicle.

Though this Thyssen Henschel private initiative has involved considerable financial investment, the risk has been reduced by developing a promising AFV family which could be adapted to meet the needs of many potential customers. Compared with similar light AFVs, the TH 495 to some extent represents a "full-scale" fighting system with good growth potential. Nonetheless, competition is fierce and the attractions of buying alternative, cheaper, off-the-shelf vehicles such as the French VAB or the Swiss Piranha are self-evident.

♦♦

# YOUR BEST PARTNER IN AIR DEFENCE.

**oerlikon-contrales**

Zürich • Roma • Milano • Stockach • Pittsburgh • St. Jean-sur-Richelieu

# Technology Beyond Limits

[Press & News](#)

[Exhibitions](#)

[Media database](#)

[Latest news](#)

■ 29.03.2007  
 Press Release  
 Significant increase in sales at Krauss  
 Sales plus 70 percent Further  
 development of European network  
[» more](#)

## Special

Operation  
 "Medusa" in  
 Afghanistan  
 The PzH 2000  
 for the first time  
 demonstrates its mobility and fire  
 power in tough operational  
 environments  
[» more](#)



FENNEK

Highly protected  
 vehicle family  
[» more](#)



LEOPARD 2

PSO Peace  
 Support  
 Operation  
 New MBT for  
 Peace Support Operations



## PUMA infantry fighting vehicles

The most modern system of its kind in the world

The PUMA infantry fighting vehicle sets new international standards in technology and design. Under the umbrella of Projekt System und Management GmbH (PSM) headquartered in Kassel, Krauss is developing this ambitious future program together with the company Rheinmetall Landssysteme. In 2009, the PUMA will replace the Marder which has been used by the German army for 30 years. Its level of protection, deployability and usefulness in networked operations are internationally unique.

High flexibility from a two-level protective system

The PUMA offers its occupants maximum protection during use. The corresponding system is built on two levels. In its air-transportable configuration (which includes maximum mine protection), the PUMA can be moved by the new Airbus A400M military transporter. Thanks to its modular construction, it can be quickly equipped to the combat level of protection in the field. The cohesive interior of the PUMA takes into account the great needs of troops for command, communications, protection and ergonomics. These and other features are an expression of the PUMA's internationally unique vehicle design.



### Specifications

Total weight	43 t
Weight at protection level A	31,45 t
Weight at protection level C	40,7 t
Crew	9 (6+3)
Maximum speed	70 km/h
Length at protection level C	7,33 m
Width at protection level C	3,71 m
Height at protection level C	3,05 m
Main weapon	30 mm (MK 30-2/ABM)

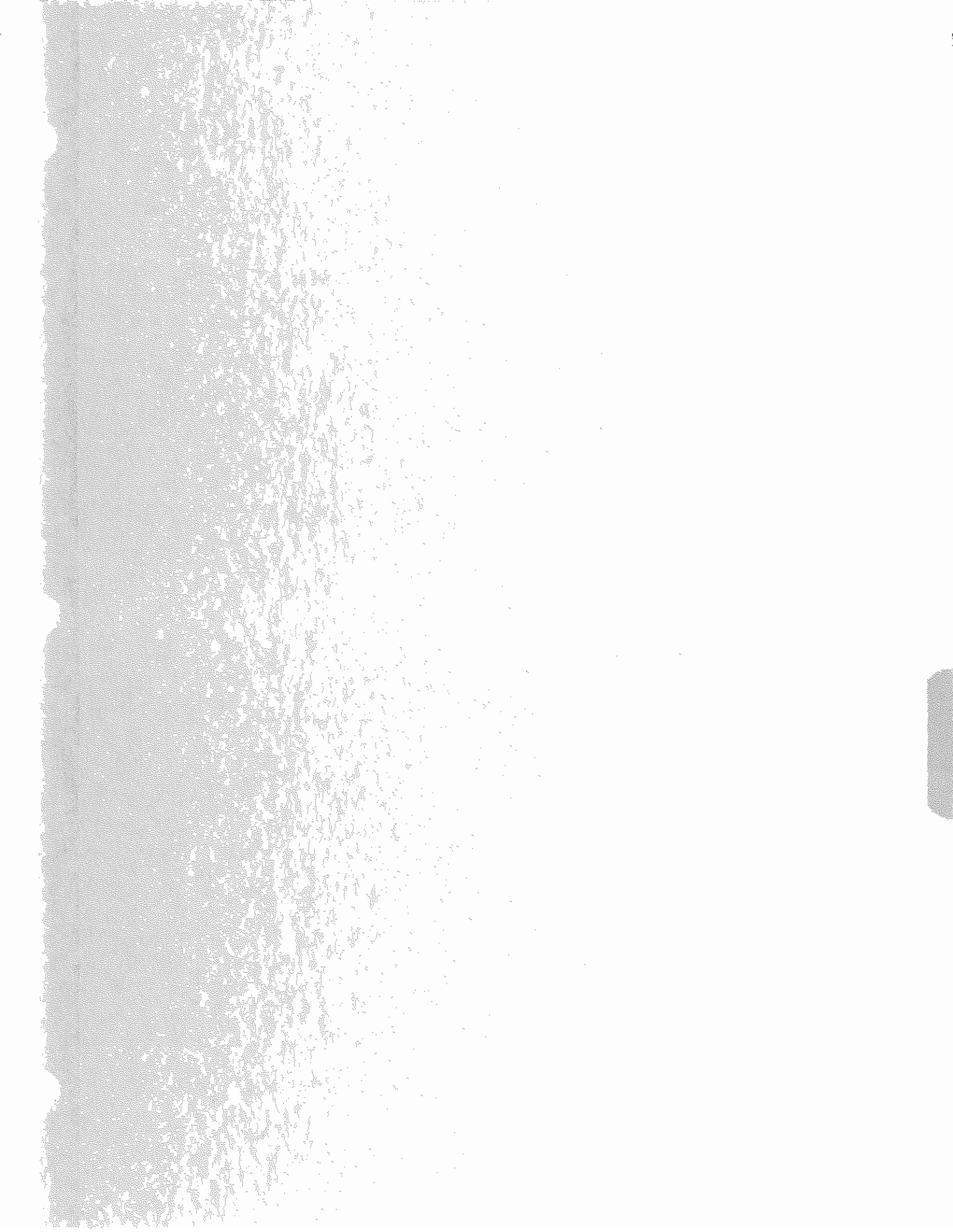

KARLHEINZ SCHREIBER

7 BITTERN COURT, ROCKCLIFFE PARK  
OTTAWA, CANADA K1L 8K9

TELEPHONE 613 748 7330  
FACSIMILE 613 748 9697  
schreiberbarbel@aol.com

The Right Hon. Brian Mulroney, P.C., LL .D.  
47 Forden Crescent

Per Fax 1 514 369 9393

Westmount, Quebec  
H3Y 2Y5

Ottawa, April 14, 2007

**Subject: Return of \$ 300.000,00 cash payments.**

Dear Brian,

On March 20, 2007 your lawyer Kenneth Prehogan sent a letter to my Lawyer Richard Anka Q.C.

He wrote: "*Mr. Mulroney denies that he owes any money to Mr. Schreiber.*"

I have a different understanding and I recommend that you will ask your friend Fred Doucet helping you to refresh your memory concerning the money and what it was for.

He will be a witness anyway.

Yours truly,

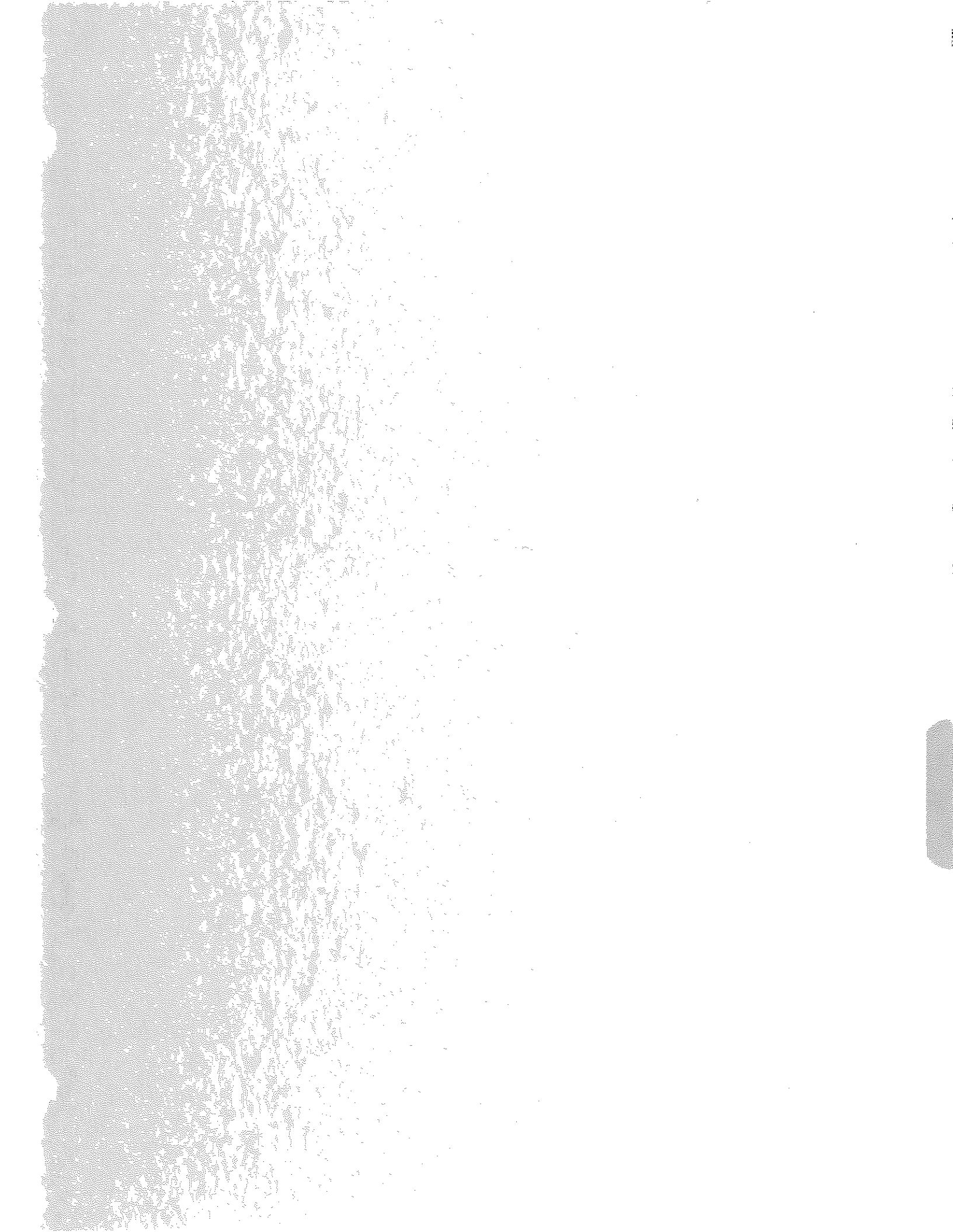



KARLHEINZ SCHREIBER

7 BITTERN COURT, ROCKCLIFFE PARK  
OTTAWA, CANADA K1L 8K9

TELEPHONE 613 748 7330  
TELEFAX 613 748 9697  
schreiberbarbel@aol.com

The Right Hon. Brian Mulroney, P.C., LL .D.  
47 Forden Crescent

Per Fax (1) 514 369 9393

Westmount, Quebec  
H3Y 2Y5

Ottawa, April 15, 2007

**Subject: Child obesity an epidemic in Canada: Report**

**"For the first time, Canada's younger generations are expected to live shorter lives than their parents."**

Dear Brian,

On April 10, 2007 I took the liberty to send you some information concerning our soldiers in Afghanistan and the problems they have with their armoured vehicles and their tanks.

I also sent you a copy of my letter March 16, 1993 concerning the armoured vehicles of the Canadian forces as a reminder.

**Today I like to get your attention concerning my letter from July 2004 as a reminder to the: "PASTA BUSINESS" and my request for your support to fight child obesity.**

I did not even get an answer from you and on top of this you refused to see Elmer MacKay and Mike Cochrane when they wanted to talk to you about the anti obesity project.

Contrary to His Royal Highness Prince Charles, Bill Clinton, Tony Blair, Arnold Schwarzenegger, Jamie Oliver, Dr. Arya Sharma, scientific director of the newly

established Canadian Obesity Network, The George Brown Toronto City College, The "George Brown Chef School" and many others, who care about our children.

See the attachments:

Canada .com: Child obesity an epidemic in Canada, March 26, 2007.

Globe&Mail.com: Canadians fatter than previously thought, Jun 13, 2006

Globe&Mail.com; We're raising fat children, April 21, 2005

CBC NEWS: Europeans O K Anti-Obesity Charter, November 16, 2006

Associated Press: Clinton takes on childhood obesity, May 4, 2005

BBC News: California bans school junk food. Governor Arnold Schwarzenegger has signed legislation... "California is facing an obesity epidemic" Mr. Schwarzenegger said.

Der Spiegel: Jamie Oliver with Prince Charles concerning the program "Feed me better!" July 26, 2005

BBC News: Junk food to be banned in schools, Ruth Kelly and Tony Blair September 28, 2005

Globe&Mail.com: Child obesity shocks Commons committee March 27, 2007

**Reto Pasta Demonstration Project – The George Brown Chef School.**

Looking back to the past 30 years, I have been in contact with you; I have to confess that in my opinion you did not care for

The lives of Canadian soldiers

The health of Canadian children

The Canadian environment

The jobless people of Nova Scotia, where you once had promised three things: "Jobs, jobs, jobs!"

The friends that helped you, when you needed them badly

The International Industry which had confidence in you.

There was a time I was embarrassed when people or the media called you:  
"Lying Brian."

Times have changed. Today I believe, if the lie itself would look for a proper  
label, it would choose your name and your face!

In my opinion this is a very sad story.

Yours truly,

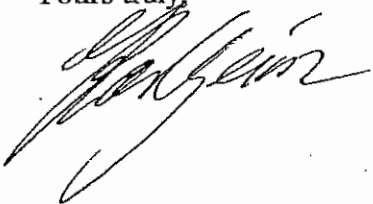
A handwritten signature in black ink, appearing to read "Bob Gein". The signature is written in a cursive style with a large, sweeping initial letter.

## Child obesity an epidemic in Canada: report

For first time, Canada's younger generations are expected to live shorter lives than parents

**JULIET O'NEILL**

CanWest News Service

Wednesday, March 28, 2007

More Canadian children are overweight and for the first time the country's younger generations are expected to live shorter lives than their parents because of obesity, says a new Commons committee report made public yesterday.

Committee MPs said they were "shocked" to learn about the increase in overweight children, from 12 per cent to 18 per cent, and obese children, from three per cent to eight per cent, between 1978 and 2004.

That makes about one in four Canadian children overweight or obese.

The report said parents must be in denial, as a Canadian Medical Association survey found only nine per cent report they have a child who is at least somewhat overweight.

The health committee called yesterday for aggressive measures to halt child obesity, and said they share fears of experts that "today's children will be the first generation for some time to have poorer health outcomes and a shorter life expectancy than their parents."

Highlights of recommendations are a ban on trans fats as advised by a federal task force; use of a mandatory, simplified, standardized food labelling system; and designation of federal funds to build or replace aging playgrounds, sidewalks, rinks, pools and other community exercise spots across the country.

The report said most Canadian children spend too much time in front of TV and computer screens; don't get the expert-recommended 90 minutes a day of exercise; eat too much fat and junk food; consume too many sugary drinks and don't eat the recommended five daily servings of fruit and vegetables.

The committee also reported the "distressing" and "most alarming" number of 55 per cent of First Nations children living on reserves, and 41 per cent off reserves, are overweight or obese.

There is so much poverty among First Nation and Inuit people that many people cannot afford nutritious food, especially in remote northern communities, the report said.



CREDIT: Marcos Townsend/Gazette file photo

More Canadian children are overweight and for the first time the country's younger generations are expected to live shorter lives than their parents due to obesity, says a new Commons committee report released Tuesday.

And of more than 500 First Nations schools, only half have a gym.

The health committee proposed Canadians take up a national challenge to halt a 30-year rise in overweight children in just three years - by the 2010 Olympic games in Vancouver. Then targets to reverse the trend could kick in.

"It is ambitious but it is doable," committee chairperson Rob Merrifield, an Alberta Conservative MP, told a news conference.

"For the first time in recorded history, our younger generations are expected to live shorter lives than their parents due to obesity," he said in a prepared statement.

"New and aggressive action is required to address this complex and, ultimately, very costly problem."

The report was welcomed by the Heart and Stroke Foundation, which has long warned "fat is the new tobacco," and by the Canadian Medical Association.

Foundation chief Sally Brown said overweight children are on "a fast track" to developing hypertension, heart disease and stroke.

New Democratic Party MP Penny Priddy said by chronicling links between poverty, poor diet and lack of exercise, the report busts a myth that overweight children all sit around playing on computers and watching TV. She cited the example of children in poor families being fed Kraft Dinner instead of going to bed hungry.

Kraft Dinner is a brand of macaroni and cheese, an inexpensive food.

Expressing concern that the committee would get into trouble with the Kraft corporation, Merrifield said "I love Kraft Dinner."

The report said on average, adolescents in Canada spend almost 35 hours a week in front of a TV or computer screen - more time than in the classroom over the course of a year. Studies had shown the less time in front of a screen and the more activity, the less weight.

The committee also postponed a decision on a possible ban on food advertising to children, saying it would assess the impact of self-regulation in Quebec, Sweden and other jurisdictions in a year before deciding on the issue.

Bloc Quebecois MPs issued a dissenting report, saying the Quebec government already has a well-defined strategy to deal with juvenile obesity and that the federal government should stick to its own jurisdiction in health, which is confined to First Nations and Inuit people.

Ottawa Citizen

© The Gazette (Montreal) 2007

**CLOSE WINDOW**

Copyright © 2007 CanWest Interactive, a division of CanWest MediaWorks Publications, Inc. All rights reserved.

POSTED AT 9:30 AM EDT ON 13/06/06

## Canadians fatter than previously thought

ANNE-MARIE TOBIN  
CANADIAN PRESS

Ottawa — The expanding waistlines of Canadians are nothing new — obesity has been one of the country's biggest health problems for years now — but a new Statistics Canada survey indicates that the population is actually fatter than previously thought.

The reason? It seems that when a survey simply asks a respondent for their height and weight, the results are not the same as when people are actually weighed and measured.

Detailed data released Tuesday as part of the Canadian Community Health Survey of more than 130,000 people indicate that the national obesity rate in 2005 was 15.5 per cent. But that rate is based on people who volunteer their own weight and height.

The survey also did a smaller sample of 4,000 people who were put on a scale and had their height measured by a Statistics Canada interviewer.

The results are interesting not only to health-care officials, but may also be of interest to sociologists. Because men tended to overestimate their height and women generally underestimate their weight, Statistics Canada says an extrapolation of the people who were measured works out to a national obesity rate of 24.3 per cent.

Dr. Arya Sharma, scientific director of the newly established Canadian Obesity Network, said some people offering their own heights and weights "might be making true mistakes, not knowing."

"A lot of people don't weigh themselves regularly. They may just recall the last time they stepped on a scale, and it might have been a while ago. Some of it might just be wishful thinking. Some of it might be just embarrassment. There could be all kinds of reasons."

People lose height over time and can gain weight without realizing it, he added.

"Measured is a better reflection of reality," said Vincent Dale, survey manager of the CCHS. But because this sample size was small, an obesity rate based on measured data was not available for the provinces or at the community health region level.

Easier-to-gather self-reported numbers continue to be the norm when most large surveys are conducted, but now experts can factor in what they know about the discrepancy between the two methods.

No matter how you measure it, obesity among Canadians is a problem that is getting worse.

In terms of regional variation, Canadians get slimmer as you move from east to west. Among provinces, the highest obesity rates were in Newfoundland and Labrador, where 23.8 per cent of the population was obese (self-reported data). By comparison, the rate was 13.2 per cent in British Columbia.

Nunavut had the worst obesity rate in the country – at 25.9 per cent. And nearly four in 10 women were obese in the northern Saskatchewan health region of Mamawetan/Keewatin/Athabasca.

Again, these numbers are all self-reported, and Mark Tremblay, a professor of kinesiology at the University of Saskatchewan, noted that self-reporting systematically underpredicts the extent of the obesity problem.

He said that “anyone in the know” recognizes that self-reported data are clearly an underestimate. “The degree to which it is underestimated, we’re not sure – well, we’re becoming increasingly sure now.”

The latest measured numbers appear to confirm the findings of a 2004 nutrition survey based on actual weighing and measuring where the obesity rate landed at 23.1 per cent.

Mr. Sharma, who holds a Canada Research Chair in cardiovascular obesity research at McMaster University in Hamilton, said it is great to have more “precise” data now.

“I think that level of obesity was always out there,” he said. “It was just not being recorded.”

Overweight and obesity rates are based on the Body Mass Index (BMI), which is calculated using a person's height and weight to gauge total body fat.

A BMI of 25 or more in adults indicates someone is overweight. A BMI of 30 or more indicates obesity and a high to extremely high risk of developing health problems.

For example, an adult male who is 5-foot-10 and weighs 210 pounds would have a BMI of 30 and would be considered obese. A woman who is 5-foot-4 and 175 pounds would also have a BMI of 30.

There are various issues surrounding the use of BMI, because it doesn't tell you anything about body composition, noted Mr. Tremblay, who is also a senior scientific adviser on health measurement for Statistics Canada.

“There is the sort of Arnold Schwarzenegger argument, that if you measured all of the NFL linebackers in the National Football League or the equivalent in some other sport, you'll find that the majority of them are obese by BMI indexes. ... They're heavy for their height because they're very muscular,” he said.

“However, I think it's reasonable to assume that most Canadians have not become increasingly like NFL linebackers over time, at least that seems like a reasonable assumption to me,” he noted.

“The more viable explanation for the BMI creep that we're seeing in the country is that Canadians, and Americans and almost every other country in the world, are becoming increasingly fat.”

Waist girth is a very good index to measure health risks. Even better is taking skin-fold measurements, and better than that is an MRI, Mr. Tremblay said.

Mr. Sharma said he thinks people lack a good feel for the importance of obesity as a contributor to disease, and most who try losing weight do so for cosmetic reasons.

“People are a lot more scared of high blood pressure and cancer and a lot of other things, and not realizing that the excess body weight is killing them. It's killing them slowly but it's killing them steadily.”

© Copyright 2006 Bell Globemedia Publishing Inc. All Rights Reserved.

*Bell Globemedia*

globeandmail.com and The Globe and Mail are divisions of Bell Globemedia Publishing Inc., 444 Front St. W., Toronto, Canada M5V 2S9  
Phillip Crawley, Publisher



## **We're raising fat children**

BY OLIVER MOORE

THURSDAY, APRIL 21, 2005  
UPDATED AT 7:35 AM EST  
FROM THURSDAY'S GLOBE AND MAIL

New research shows that Canadian kids are near the top of a list no one wants to be on – ranking among the fattest in the world.

The results stem from a massive study of more than 162,000 children aged 11, 13 and 15 from 34 countries, which showed that Canadian youths are pulling ahead of just about everyone else in the world.

Close to 20 per cent (19.3) of Canadian youths are overweight, higher than that for youths of every country studied except Malta, the United States and England. They are also more likely to be obese (4.1 per cent of those studied) than youth in every country except Malta, the U.S., Wales and Greenland.

The study, by Queen's epidemiologist Ian Janssen, finds young people in Canada are increasingly sedentary, and the effect is showing.

"Physical activity interventions should be a fundamental component of health campaigns aimed at reducing the global obesity epidemic," said Dr. Janssen, whose work is to appear in next month's issue of *Obesity Reviews*, a journal of the International Association for the Study of Obesity.

The article notes that physical activity levels were lower and television viewing times tended to be higher in overweight compared with normal-weight youth.

The authors note that, in more than three-quarters of the countries studied, at least 10 per cent of the youth were overweight.

The study used international standards for body-mass index, which is an approximation of body fat, based on height and weight. Those with a BMI higher than 25 were classified as overweight, those over 30 were classified as obese.

Summing up his work with these thousands of youths, Dr. Janssen argues that "the adolescent obesity epidemic is a global issue."

That assessment was backed yesterday by Gerry Predy, chief medical officer for Edmonton's capital health region.

"The biggest problem is that fat kids grow up to be fat adults," he said. "Our future generations certainly are not going to be as healthy as current generations."

Dr. Predy said that there remain serious variables in weight problems across the country, with the

effects worst in poor rural areas. Speculating about the inclusion of Greenland near the top of Dr. Janssen's list, he said that the same socio-economic conditions would likely be at play in Canada's north and that serious weight problems would probably be found there.

Oddly enough, Dr. Janssen's study also found a link between the frequency candy is eaten and the likelihood that a child will be overweight. But it's not the link you might expect.

Studying frequency, not volume, Dr. Janssen found that the more often youths ate candy the less likely they were to be heavy.

"This does not mean that eating sweets in large quantities is recommended for young people," he was quick to stress.

These results are certainly odd, Dr. Predy acknowledged, and shouldn't be taken too quickly to heart. "Certainly there are data to suggest that people who eat more frequently and eat less amounts each time they eat are less likely to be overweight or obese," he said cautiously.

John Spence, an associate professor of physical education and recreation at the University of Alberta, said he is surprised the study found no link between drinking pop and obesity.

"There has been some research to show that increases in soft drink consumption over the last 30 years may have been related to the subsequent increase in body weight that we are seeing in the population," Mr. Spence said from Edmonton, noting that overweight or obese kids tend to under-report caloric intake in such surveys.

And he said TV watching is but one of the sedentary pastimes contributing to the obesity epidemic, especially in North America, where a growing reliance on the automobile means fewer daily activities such as walking or bike riding.

*With a report from Canadian Press*

© Copyright 2005 Bell Globemedia Publishing Inc. All Rights Reserved.

## HEALTHWATCH

E-MAIL | PRINT | DELICIOUS

AnswerTips™ enabled (What's this?)

### Europeans OK Anti-Obesity Charter

European health ministers from 53 countries approve anti-obesity charter

Health Main Page

WebMD

Healthy Living

Early Show: Health News

Shape Up

Dr. Emily Senay

CBS Cares

Audible.com Downloads

HealthWatch Video

LONDON, Nov. 16, 2006

By MARIA CHENG AP Medical Writer



(AP) European health ministers from 53 countries approved the world's first charter to fight obesity on Thursday, vowing greater action against the epidemic of expanding waistlines across the continent.

The charter, approved in Istanbul, Turkey, was drafted by the World Health Organization in consultation with its European member states. It is the first real attempt to compel national authorities to take concrete action to combat obesity.

"Lots of governments have good recommendations and nice guidelines, but in terms of nutritional goals, most countries haven't achieved them," said Dr. Francesco Branca, WHO's European adviser for nutrition and food security. The charter commits governments to things like improving the availability of healthy foods and adopting regulations for safer roads to

(AP)

promote cycling and walking.

The prevalence of obesity in Europe has tripled in the past two decades; half of all adults and 20 percent of all children are overweight. Being overweight or obese increases the likelihood of diseases such as diabetes and cancer, and shortens life expectancy. Obesity is also responsible for up to 6 percent of all health care costs across Europe.

The WHO charter aims to curb the epidemic in the next five years, and hopes to reverse the trend by 2015.

#### FAST FACTS



**E. coli**  
Learn more about a dangerous strain of a common bacteria.

#### INTERACTIVE



**AIDS: The Modern Pandemic**  
A history of AIDS, U.S. statistics, health facts and a look at how the epidemic has spread.

#### INTERACTIVE



**Bird Flu Soars**  
Follow the spread of the virus around the globe, find out about the threat to humans and get details about U.S. preparations

Still, Branca admits that putting Europe-wide policies into place that tackle issues as diverse as improving national dietary guidelines and urban planning, to allow for more regular physical activity, will take some time. With countries being overrun by fast food chains and a decreasing number of people exercising regularly, experts say that the European environment has become conducive to an unhealthy lifestyle.

The problem is particularly acute in children. Overweight and obese children are likely to remain so into adulthood, leading to the early onset of related diseases. "The charter represents a major turning point in addressing the challenges of childhood obesity," said Prof. Phillip James, president-elect of the International Association for the Study of Obesity.

One of the charter's more contentious inclusions is an obligation for the private sector to limit the marketing of fatty, sugary foods to children. It calls for specific regulatory measures to "substantially reduce" the advertising of unhealthy foods to children.

The clause implies that governments should introduce legislation regarding marketing to children, with an eventual move to adopting an international code of practice. In the past, the food industry has fought against such regulation, since it may eat into their profits.

Across Europe, there are marked policy differences in advertising to children. Norway and Sweden have banned the practice. In contrast, in the Netherlands, Portugal, and Spain, food and drink industries engage in self-regulation.

To some experts, advertising unhealthy foods to children crosses the lines of fair business play. "The commercialization of children must stop," said James, who was reassured by the inclusion of the marketing clause in the charter. "This signals that we haven't done enough to protect children from the advertising environment, and now need to move decisively."

While the numbers are grim, with 150 million adults and 15 million children expected to be obese by 2010, rapid action now might yet control this epidemic, experts say. "Everyone says it takes a generation to reverse this, but it doesn't," argues Branca. The dramatic spike in obesity, he says, has only occurred in the past decade. "If we work together now, we might be able to change the obesity trend at the same speed at which it happened."

MMVI The Associated Press. All Rights Reserved. This material may not be published, broadcast, rewritten, or redistributed.

[Back To Top](#)

SEARCH

SEARCH : [- Show Search Options](#) - [Search Tips](#)

**Wireless Alerts:** [CBS News To Go](#) **E-Mail Sign-Up:** [Breaking News](#) | [Today On CBS News](#) | [60 Minutes](#) | [48 Hours](#) | [The E](#)

**Recommended Sites:** [CBS Corporation](#) | [The ShowBuzz](#) | [CBS.com](#) | [CBS SportsLine](#) | [CWTV.com](#) | [ETOnline.com](#) | [The Site Map](#) | [Video Site Map](#) | [RSS News Feeds](#) | [Help](#) | [Advertise With Us](#) | [Contact Us](#) | [NEW: Terms of Use](#) | [NEW: Privacy](#)

 **CBS NEWS** © MMVII, CBS Interactive Inc. All Rights Reserved.

## Clinton takes on childhood obesity

By KAREN MATTHEWS  
ASSOCIATED PRESS WRITER

NEW YORK — Former President Clinton and Arkansas Gov. Mike Huckabee - two politicians whose love of junk food landed them in the hospital - are hoping to help the next generation shape up.

The two announced a campaign Tuesday to stem the tide of obesity by encouraging children to create lifelong healthy habits that emphasize better nutrition and increased activity.

"The truth is that children born today could become part of the first generation in American history to live shorter lives than their parents because so many are eating too much of the wrong things and not exercising enough," Clinton said.

Clinton and Huckabee vowed to halt childhood obesity in the United States by 2010. Estimates are that 16 percent of U.S. children are obese, making them susceptible to such life-threatening illnesses as heart disease and diabetes.

Clinton's motivation for getting involved was the heart bypass surgery he had last September; Huckabee's was the 110 pounds he lost after being diagnosed with Type II diabetes.

"Two years ago I would not have been asked to be here today to speak to this issue, for the simple reason that I would have been about the worst role model you could have had," he said.

The men spoke at a school around the corner from the hospital where Clinton was operated on last year.

They said they would work with schools, communities, the restaurant and food industry and the media to develop programs and policies designed to encourage healthier food choices and more exercise. An interactive Web site for children 9 to 13 is also in the works.

"We're going to give this our best shot because we want all these children to live to be 90 years old and to be healthy doing it," Clinton said.

Few specific measures were outlined and no dollar figure was provided for the campaign, a joint project of the American Heart Association and the William J. Clinton Foundation.

"When the American Heart Association approached me about working together to combat heart disease, I wanted to do more than just tape a public service announcement because of what had been done for me and because I had frankly dodged a very big bullet," Clinton said.



Arkansas Gov. Mike Huckabee, left, addresses reporters as former President Bill Clinton looks on during a news conference, Tuesday, May 3, 2005 in New York. Clinton and Huckabee announced the launch of a 10-year initiative to combat childhood obesity, calling it a national epidemic. (AP Photo/Mary Altaffer)

The initiative pointed out that the number of overweight children has more than doubled since in 1980. Overweight children and adolescents have about a 70 percent chance of becoming overweight adults, and, if the trend continues, it could cut two to five years from the average lifespan.

Huckabee, whose book "Quit Digging Your Grave With a Knife and Fork" comes out next week, said others must take personal responsibility, as he did. Of the food industry, he said, "when the marketplace demands healthier choices, they'll be presenting them."

Childhood obesity experts said having prominent names associated with the issue can only help, but the food industry and the government must play a role.

"You have to get industry involved," said Lisa Altshuler, director of the Kids Weight Down Program at Maimonides Medical Center in New York City. "They're such a major part of the problem they have to be part of the solution."

--

On the Net:

Heart Association: <http://www.americanheart.org>

Clinton Foundation: <http://www.clintonfoundation.org>



News Front Page

Last Updated: Friday, 16 September 2005, 10:50 GMT 11:50 UK

E-mail this to a friend

Printable version



- Africa
- Americas
- Asia-Pacific
- Europe
- Middle East
- South Asia
- UK
- Business
- Health
- Science/Nature
- Technology
- Entertainment

# California bans school junk food

**Governor Arnold Schwarzenegger has signed legislation to ban some junk foods from California high schools, in an effort to stem child obesity.**



High-fat foods will have to be replaced with healthier options

"We are going to terminate obesity in California once and for all," the former bodybuilder and actor said.

The new laws extend to high schools a ban on soft drinks already in place at primary schools.

New limits on fat and sugar content have also been set for vending-machine snacks and food sold in school stores.

Federal nutrition standards currently cover the lunches served by most state-funded schools.

## Healthy options

Mr Schwarzenegger signed the bills after walking 1km (0.62 miles) with bicycle racing champion Lance Armstrong and hundreds of schoolchildren.

"California is facing an obesity epidemic," Mr Schwarzenegger said. "Today we are taking some first steps in creating a healthy future for California."

Under the new rules, pizza, burritos, pasta and sandwiches must contain no more than four grams of fat for every 100 calories, with a total of no more than 400 calories.

From 2007, students will only be allowed to buy water, milk and some fruit and sports drinks that contain a controlled amount of sweeteners.



Schwarzenegger is a long-time health campaigner

It is thought that the move could cost school districts

### SEE ALSO:

- US people getting f... 25 Aug 05 | Health
- State backs school... 26 May 05 | Educa
- Tough line on scho... 09 Feb 04 | Educat
- New York schools to... sales
- 30 Jun 03 | Educat
- Junk food battle hit... 30 May 02 | Ameri

### RELATED INTERNET

State of California  
The BBC is not respo... content of external li

### TOP AMERICAS STO

- Hurricane Rita cras
- Puerto Rico rebel's
- Ancient Peruvian ar
- Cheney to undergo
- | What is RS

BBC SPORT

BBC WEATHER

LANGUAGES

hundreds of thousands of dollar in lost income, as they receive money from companies in return for allowing them to sell their products in schools.

Susan Neely, president of the American Beverage Association, called the soda ban "unnecessary", and said that students would have been better served by a voluntary programme.

School nutritionists have welcomed the changes.

"We won't be selling 10oz (283g) burritos at 700 calories and shouldn't be," Marty Marshall, legislation chairwoman of the California School Nutrition Association, told the Los Angeles Times newspaper.

E-mail this to a friend

 Printable version

**LINKS TO MORE AMERICAS STORIES**

Select

[News Alerts](#) [E-mail services](#) [Mobiles/PDAs](#)

[Help](#) | [Privacy and Cookies Policy](#) | [News sources](#) | [About the BBC](#) | [Contact us](#)



26.07.2005

EXTRA ONLINE

### Fett statt fit: Die dicken Kinder von London

Starkoch Jamie Oliver (mit Prinz Charles): Seine Petition "Feed me better!" fand ein großes Echo.



AP

News Front Page



Africa

Americas

Asia-Pacific

Europe

Middle East

South Asia

UK

England

Northern Ireland

Scotland

Wales

UK Politics

Education

Magazine

Business

Health

Science/Nature

Technology

Entertainment

Have Your Say

In Pictures

Week at a Glance

Country Profiles

In Depth

Programmes

**BBC SPORT**

**BBC ALTERNATIVE**

Last Updated: Wednesday, 28 September 2005, 14:26 GMT 15:26 UK

E-mail this to a friend

Printable version

## Junk food to be banned in schools

Foods high in fat, salt or sugar are to be banned from meals and vending machines in English schools.



Ruth Kelly and Tony Blair attended a school breakfast club in Brighton

The ban, from next September, has been announced by Education Secretary Ruth Kelly at the Labour Party conference.

Vending machines in schools will not be allowed to sell chocolates, crisps or fizzy drinks, Ms Kelly announced.

The School Meals Review Panel next week will announce details of the nutritional standards for ingredients that will be allowed in school meals.

### Junk food scandal

"I am absolutely clear that the scandal of junk food served every day in school canteens must end," said Ms Kelly.

"So today I can announce that we will ban poor quality processed bangers and burgers being served in schools from next September."

The review panel, an expert advisory group, was set up

### SCHOOL FOOD BAN

Burgers and sausages from

**BBC NEWS: VIDEO AND AUDIO**  
See what schoolchildren think of the junk food ban



### SCHOOL MEALS

#### LATEST DEVELOPMENTS

- Meals watchdogs appointed
- TV chef applauds £280m plan
- Money welcome: details awaited
- Wales: Ingredients 'average 49p'
- Scotland 'ahead already'
- School dinners 'gimmick' denied
- Blair supports TV chef's campaign
- Dinner ladies on the front line
- NI caterers challenge chef

### FEATURES

- Pupils profit from healthy meals
- What other countries do
- Will they still eat chips?
- 'Retro style' for school dinners

### PROFILE

The pukka Jamie Oliver

### BBC ACTION NETWORK

#### School dinners

Advice and contacts to help you take action and make a difference



after a campaign to improve school meals by TV chef Jamie Oliver.

In response, the government promised extra funding to bring the primary school meal budget up to 50p per pupil per day, with 60p for secondaries - and created the panel to set minimum nutritional standards.

These will be introduced from this term - and will become mandatory from September 2006.

Monitoring the standards of food served to pupils will be part of the responsibility of Ofsted school inspectors.

### Poor quality

Speaking on BBC Breakfast, Ms Kelly said it was "common sense" that some sorts of foods should be excluded from school menus.

"For example, meat products that are made from reconstituted meat slurry that bears no resemblance to the original product."

But plans to raise the standard of school food will not benefit pupils in local authorities where there is no school meals service.

Joe Harvey, the director of the Health Education Trust, which has advised the government, said it was time for schools to abandon their reliance on the quick fix of junk food.

'meat slurry' and 'mechanically recovered meat'  
Sweets including chewing gum, liquorice, mints, fruit pastilles, toffees and marshmallows  
Chocolates and chocolate biscuits  
Snacks such as crisps, tortilla chips, salted nuts, onion rings and rice crackers

panel to set minimum

**RELATED INTERNET LINKS:**  
Department for Education and Skills

The BBC is not responsible for the content of external internet sites

### TOP EDUCATION STORIES NOW

Junk food to be banned in schools  
School's healthy vending struggle  
Heads doubt healthy lunch plan  
Schoolboy told Pc he was 'scum'



| What is RSS?



Head teachers sceptical  
Healthy vending struggle  
New menus prove popular

## Child obesity shocks Commons committee

**BRODIE FENLON**  
GLOBE AND MAIL UPDATE

Toronto — Canada should ban trans fat and launch a major public-awareness campaign to prevent an "obesity epidemic" from lowering the life expectancy of Canada's children, says an all-party Commons committee that has been studying the issue since last June.

The report says 26 per cent of Canadians aged 2 to 17 are overweight or obese, compared with 12 per cent in 1978. "The committee was shocked to hear how much overweight and obesity rates among children and adolescents in Canada have increased over the past three decades," it says.

"The committee shares the fears of many experts who predict that today's children will be the first generation for some time to have poorer health outcomes and a shorter life expectancy than their parents."

The committee wants the government to set hard targets to halt the rise by 2010, in time for the Vancouver Olympic Games, and to reduce obesity rates in children 2 per cent by 2020.

### Related to this article

#### Articles

- [Trans fats linked to greater heart disease risk](#)

#### Internet Links

- [Healthy Weights for Healthy Kids \(pdf\)](#) 

#### Follow this writer

- [Add BRODIE FENLON to my e-mail alerts](#) 

#### Latest Comments

- A lot of people are posting about the things we can do to control...
- PART THREE. Dr. Mephistopheles, so far the only logical dairy...
- Whenever I do around the centre of a large city such as Ottawa...
- Child obesity shocks Commons committee. Wow. There's a surprise...
- [295 reader comments | Join the conversation](#)



"We've got a serious problem," said Conservative MP Rob Merrifield, chairman of the standing committee on health.

"We've got to do a paradigm shift and it's going to take a concerted effort by every Canadian," he

said, comparing the challenge with the campaign to persuade people to use seat belts.

"The public needs to know, more than anything else, they're just eating larger meals than they should eat for the amount of exercise they are expending," he said.

For children, those meals too often include fatty and processed foods and sugary drinks loaded with calories. The report says that sugary drinks may be responsible for as much as one pound a month of weight gain in adolescents.

Obesity costs Canada an estimated \$1.6-billion annually in direct health care — 2.4 per cent of total health-care spending. There's another \$2.7-billion in indirect costs, including lost productivity, disability insurance, reduced quality of life and mental-health problems because of stigmatization and poor self-esteem, the report says.

Responding to the concerns about childhood obesity, the committee spent nine months consulting dozens of stakeholders, including dietitians, doctors, industry associations and aboriginal health service agencies.

The report, entitled *Healthy Weight for Healthy Kids*, notes that 55 per cent of aboriginal children on reserve and 41 per cent off reserve are either overweight or obese.

The most concrete recommendations include a legislated limit on trans fat — the industrially produced unsaturated fat used in baked or fried foods. Trans fats have been shown both to elevate "bad" cholesterol and lower "good" cholesterol.

The report proposes regulations that by 2008 would limit trans fat to a maximum of 5 per cent of total fat content in food, allowing the small amount of natural trans fats from some animal products. Manufacturers would not be allowed to offset the reduction with an increase in saturated fat.

The federal Trans Fat Task Force, which was co-chaired by Health Canada and the Heart and Stroke Foundation of Canada, recommended in 2006 a regulated approach to reducing the mostly industrially produced fat.

While the food industry supports the push toward reduced trans fat, it wants time to find other healthier oils, said Blake Johnston, vice-president of government affairs for Food & Consumer Products of Canada, which represents 150 Canadian companies, including Cadbury Adams, Frito-Lay, Heinz Canada and McCain Foods Ltd. The association sat on the task force and was consulted several times by the Commons committee, Mr. Johnston said.

"The concern we have as industry is that if we ban trans [fat] and we move too quickly and there's no supply of healthy alternatives, then food manufacturers will be forced to go back to saturated fat oils like palm oils," he said.

The health committee also recommends a mandatory, standardized nutrition label for the front of food packages, beginning with foods advertised primarily to children.

Companies have been required to put nutritional-content labels on the back of packaging since 2005. However, Ottawa does not control what manufacturers can say on the front.

# RETO

Pasta Demonstration Project

George Brown  
The Toronto City  
College

The George Brown Chef School



“al dente”

Pasta should never be overcooked. “al dente” is a term used to describe perfectly cooked pasta - just tender and still a little resistant, firm to the bite.

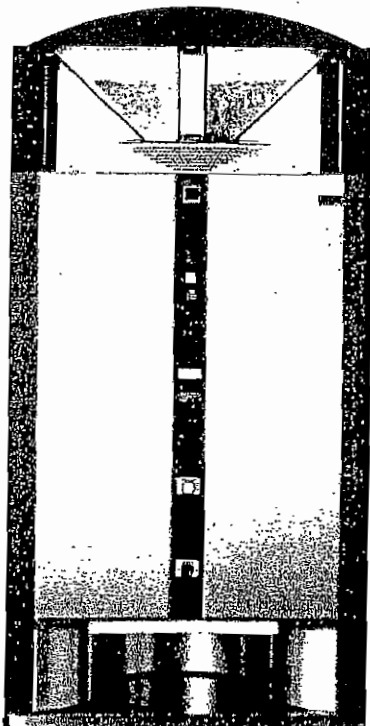

## Pasta For Life

### The Machine

Reto's machine opens the door to a new dimension of cooking pasta using space age technology. Each portion of pasta is cooked to order in fresh, filtered water without salt or oil, in just 70 seconds, with a cooking temperature of 130°C. Perfectly “al dente” and delicious - an extraordinary taste experience of Reto's Pasta Arts™. The machine is patented and produced exclusively for Reto's Restaurant Systems International™.

Durum wheat fortified pasta served “al dente” with tomato sauce.

Approximately 240 calories and total fat 0.5g

For more information, contact:

Reto's Restaurant Systems International Inc. - Ottawa Email: [rrsi@sympatico.ca](mailto:rrsi@sympatico.ca)

# Pasta for life

## THE RETO "al dente" PASTA MEAL

- Keeps you fit, slim, healthy and contributes to weight loss
- Goes well as a cold salad with fruit, protein, or vegetables
- Fights obesity, cancer, diabetes, depression, heart disease and birth defects
- Provides a healthy energy boost. Athletes who need a steady release of energy eat a pasta meal before an event
- At lunch, keeps you fit and lively
- At dinner, it is the best basis for a good sleep
- At all times, it stimulates your taste buds and fuels your muscles, brain and central nervous system
- Scientists confirm healthfulness of pasta as good carbohydrate. Scientific Consensus Statement, agreed in Rome, February 18, 2004 (Oldways)

## "THE RETO SYSTEM"

- 1 The Reto brand enriched Pasta is produced from 100% Durum Wheat Semolina.
  - Ingredients: semolina, niacin, ferrous lactate (iron), thiamin mononitrate (vitamin B1) and riboflavin (vitamin B2), folic acid.
  - No sodium, no cholesterol. Low Glycemic Index (GI) value.
- 2 Served with tomato sauce which is rich in lycopene, it is one of the most effective antioxidants. Many studies have shown that it may reduce the risk of several cancers, heart diseases and other health problems.

# RETO



## OBESITY ON TRIAL

The George Brown Chef School has agreed to participate with Reto's Restaurant Systems International in a demonstration project to provide Reto's durum wheat semolina pasta to our students. This partnership is an opportunity to provide and promote healthy food choices in schools. Special culinary sauces for the demonstration project will be prepared by the George Brown Chef School. These sauces will be the result of a half day cooking competition for second year Culinary Management students.

The first priority of the project is to help schools promote healthy eating by providing nutritious pasta meals at lunch. Offering students healthy foods at school is an important strategy in teaching lifelong healthy eating habits.





KARLHEINZ SCHREIBER

7 BITTERN COURT, ROCKCLIFFE PARK  
OTTAWA, CANADA K1L 8K9

TELEPHONE 613 748 7330  
FACSIMILE 613 748 9697  
schreiberbarbel@aol.com

The Right Hon. Brian Mulroney, P.C., LL .D.  
47 Forden Crescent

Westmount, Quebec  
H3Y 2Y5

Ottawa, May 8, 2007

Dear Brian,

The conspiracy and cover-up action of Prime Minister Stephen Harper, Brian Mulroney, Robert Douglas Nicholson, the Attorney General of Canada and the IAG of the Department of Justice are responsible for the Proceedings at the Ontario Court of Appeal concerning my extradition case.

Please find attached the copy of the letter April 3, 2007 from my Lawyer Robert Hladun Q.C. to The Hon. Robert D Nicholson, Minister of Justice and Attorney General of Canada and the copy of the letter April 27, 2007 from the International Legal Assistance Group of the Department of Justice.

The Minister missed his chance to bring back Fundamental Justice to the Department of Justice and stop the improper and illegal extradition case against me.

The time has come that you bring the whole battle with me to a peaceful and satisfying end. This is my last warning.

I am prepared to disclose:  
that you received payments from GCI, Frank Moores, Fred Doucet, Gary Ouellet ,  
that I was asked by Fred Doucet to transfer funds to your Lawyer in Geneva, (Airbus )  
what the reason was for your trip to Zuerich in 1998,  
that you asked me through my lawyers to commit perjury to protect you,  
that you supported fraud related to the Thyssen project  
and more.

It is in your hands what is going to happen. My patience comes to an end.

Yours truly,

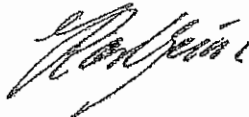

Department of Justice  
Justice

Ministère de la Justice  
Canada

International Assistance Group  
Litigation Branch (Criminal Law Division)  
284 Wellington Street, EMB-2303  
Ottawa, Ontario K1A 0H8

Telephone: 613-949-3603  
Facsimile: 613-957-8412

April 27, 2007

BY FACSIMILE: 780-424-5934

Robert W. Hladun, Q.C.  
Hladun & Company  
Barristers and Solicitors  
100, 10187 - 104 Street  
Edmonton, Alberta T5J 0Z9

Dear Mr. Hladun:

Re: *Karlheinz SCHREIBER*

Your letter, dated April 3, 2007, to the Minister of Justice has been referred to our office for response. I note that you are asking Minister Nicholson to reconsider the order of former Minister of Justice, Irwin Cotler, surrendering Mr. Schreiber to Germany.

The matters which you raise in your letter were previously advanced by both Mr. Schreiber and his extradition lawyer, Mr. Edward Greenspan, at the ministerial phase of the extradition process. Some of these issues have already been disposed of in the Court of Appeal for Ontario and through the denial of Mr. Schreiber's leave application in the Supreme Court of Canada. For ease of reference, I attach copies of the decisions of the Court of Appeal for Ontario and the Supreme Court of Canada in this matter.

I further note that Mr. Schreiber has a pending application in the Court of Appeal for Ontario for judicial review of a decision made by former Minister Toews not to interfere with Minister Cotler's surrender order on the grounds of certain statements made by the German authorities, which you also refer to in your letter. Finally, I understand that you have made an application in the Federal Court of Canada asking that the surrender order be set aside.

As such, the matters which you now raise with Minister Nicholson have either already been judicially determined or are still pending in the Canadian courts. Moreover, and as stated in previous letters to you, dated December 7, 13 and 21, 2006, Mr. Schreiber is represented by Mr. Greenspan in his extradition matter.

Please do not hesitate to contact me at 613-948-3003 if I may be of any further assistance.

Yours truly,

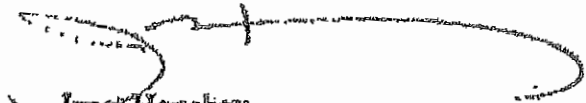

Janet Henchey,  
General Counsel and Associate Director  
International Assistance Group

Attachments

Tel. 780.424.8888  
Fax. 780.424.6934  
www.hladon.com

100, 101st - 104 Street,  
Edmonton Alberta  
T5J 0Z9  
inquiries@hladon.com

**Hladon &  
Company**  
INCORPORATED

Our File 15737.1

Your File

April 3, 2007

Via Fax: (613)942-7910

The Honourable Robert Douglas Nicholson  
Minister of Justice and Attorney General of Canada  
284 Wellington Street  
Ottawa, ON K1A 0H8

Dear Sir:

Re: Karlheinz Schreiber and the Government of Canada

I represent Karlheinz Schreiber with respect to an action he commenced in the Alberta Court of Queen's Bench in October, 1997 as a result of the Letter of Request that was sent to Switzerland in September of 1995. Mr. Schreiber has been the subject of extradition proceedings since the fall of 1999 and Edward Greenspan, Q.C. has represented his interests in that regard. On May 4, 2007, the Ontario Court of Appeal will hear an appeal relating to the surrender decision made by the Honourable Vic Towes on the 6<sup>th</sup> of December, 2006.

I recently received and reviewed a number of Crown documents in relation to the Alberta lawsuit. I have also reviewed certain newspaper articles and correspondence relating to the position the Swiss Minister of Justice has taken about the banking documents they seized then forwarded to Germany, and in which they have advised the Augsburg Prosecutors they cannot use as the documents were obtained on the basis of improper and misleading information provided by the German authorities. Incidentally, this same evidence is being relied on by the German authorities and proffered to the Canadian authorities as a basis for the extradition of Mr. Schreiber.

There is no question but that Mr. Schreiber's proceedings have taken a significant period of time. On the other hand, the fundamental principles of our justice system demand that issues of importance to Canadian citizens be dealt with in a fair, proper and reasonable manner. The purpose of my letter is to petition you to reconsider your decision to surrender Mr. Schreiber to Germany. I ask for your reconsideration as there is no question but that the cumulative effect of the matters I will outline hereunder has not been considered by any Court. The cumulative effect of the many things that have transpired over the course of the investigation is such that the principles of fundamental justice would be violated if Mr. Schreiber is returned to Germany before there has been a proper consideration of this matter, particularly a complete review of the actions of the RCMP.

Honourable Robert Douglas Nicholson

April 3, 2007

2

Therefore, I ask for your indulgence in reviewing Mr. Schreiber's position in the context of the following:

- a) the abuse of process and abuse of Mr. Schreiber's rights as gleaned from a review of RCMP actions in their investigations of Airbus and in relation to Eurocopter Canada;
- b) the misleading statement of Commissioner Murray that he did not know anything about the Letter of Request when it was he who in fact instructed an investigation into the matter when he was provided with briefing notes about the ongoing investigation;
- c) that an official letter from the Swiss Justice authorities to the German authorities withdrawing documents sent to Germany and the implication of the Germans not providing correct information to the Canadian authorities at the time they sought the assistance of the Canadian authorities and Courts;
- d) the fact that many of the charges against Mr. Schreiber are time barred in Germany and Lex Schreiber will operate retrospectively;
- e) the implications on the right to a fair trial in light of the comments made by the spokesperson for the Augsburg Court and by the Chief Prosecutor of Augsburg;
- f) that the charges against Mr. Schreiber stem as a result of political developments and issues in Germany; and
- g) that a Canadian citizen ought to be given the benefit of the legal safeguards provided in the *Charter of Rights and Freedoms* before being surrendered to a foreign government.

Mr. Schreiber's case is not the usual MLAT case in that he became the subject of the Letter of Request, a party to a lawsuit against the Attorney General, and the subject of Extradition proceedings that have been conducted by members of the IAG. It is my understanding that the IAG also provides advice to the Minister of Justice in relation to your review and decision relating to surrender. The overall impression of a reasonable person, fully informed of the circumstances of the case could be none other than that there is an apprehension of bias. The apprehension is not in relation to any one individual but more so to the office of the Minister of Justice and to the duties members of the IAG must perform. The apprehension of bias arises in the context of the appearance of the conflicts of interest in the peculiar circumstances of Mr. Schreiber's case.

The RCMP have not conducted themselves in a honorable manner in relation to this matter from the inception of the investigation in January, 1995 to the conclusion of the investigation in April, 2003. The most egregious action occurred when the RCMP, in concert with a "foreign agency", arranged to have a foreign spy ingratiate himself to Mr. Schreiber with the express purpose of entrapping Mr. Schreiber into committing a criminal act. The spy was thus instructed by the RCMP on their own accord after the RCMP had obtained the materials relating to the Letter of Request and during the time Mr. Schreiber was subject to extradition proceedings.

Honourable Robert Douglas Nicholson

April 3, 2007

3

The statements made by the Augsburg Court spokesperson and the Augsburg chief prosecutor relative to awaiting Mr. Schreiber's surrender, convey no other meaning than that Mr. Schreiber is not considered innocent and that he is not going to receive a fair and impartial trial. The comments are suggestive of the political atmosphere Mr. Schreiber faces in Augsburg. How can the Canadian government justify sending a Canadian citizen to a jurisdiction that will not adhere to the principles of fundamental justice and that appears to have prejudged Mr. Schreiber? The political nature of the actions against Mr. Schreiber is brought home with the passage of "Lex Schreiber" in the summer of 2005 whereby the Germans will extend the limitation periods relating to the charges facing Mr. Schreiber. The *Extradition Act* obliges you to consider limitation periods in making your surrender decision. How can Canada, where laws do not apply retrospectively, send a citizen of Canada to a country that has passed legislation to ensure Mr. Schreiber will be prosecuted, despite the fact that many of the charges are now time barred?

The Courts and the Minister of Justice have stated that the surrender decision is at the "extreme end of the continuum of administrative decision making" and it has been said that the decision the Minister must make is a "political one". The Swiss Minister of Justice has informed the Augsburg Prosecutors that they are not at liberty to use the documents that the Swiss officials seized. The Swiss have taken that position as they are of the view that the German authorities misled them at the time the initial request for the seizure of documents was made. The letter from the Swiss and the media commentary relating to the same are available for your review. The documents referred to are precisely the documents that were relied upon by the Honourable Mr. Justice Watt when he made his committal decision. If the documents are tainted (as the Swiss have indicated to the Germans), then there can be no other conclusion but that the committal order was made on the basis of tainted evidence. How can the government of Canada justify surrendering one of its citizens on the basis of tainted/improper evidence? It is respectfully submitted that to surrender Mr. Schreiber would be contrary to the *Charter of Rights and Freedoms*, contrary to the tenets of fundamental justice and would bring the administration of justice into disrepute.

There is no statutory nor legal obligation for Canada to extradite Mr. Schreiber to Germany; in fact, Germany would not extradite one of its citizens to Canada.

Please reconsider your decision in light of the above information and rescind the decision to surrender Mr. Schreiber to the German authorities.

Yours truly,

HLADUN & COMPANY



ROBERT W. HLADUN, Q.C.

RWH/ms

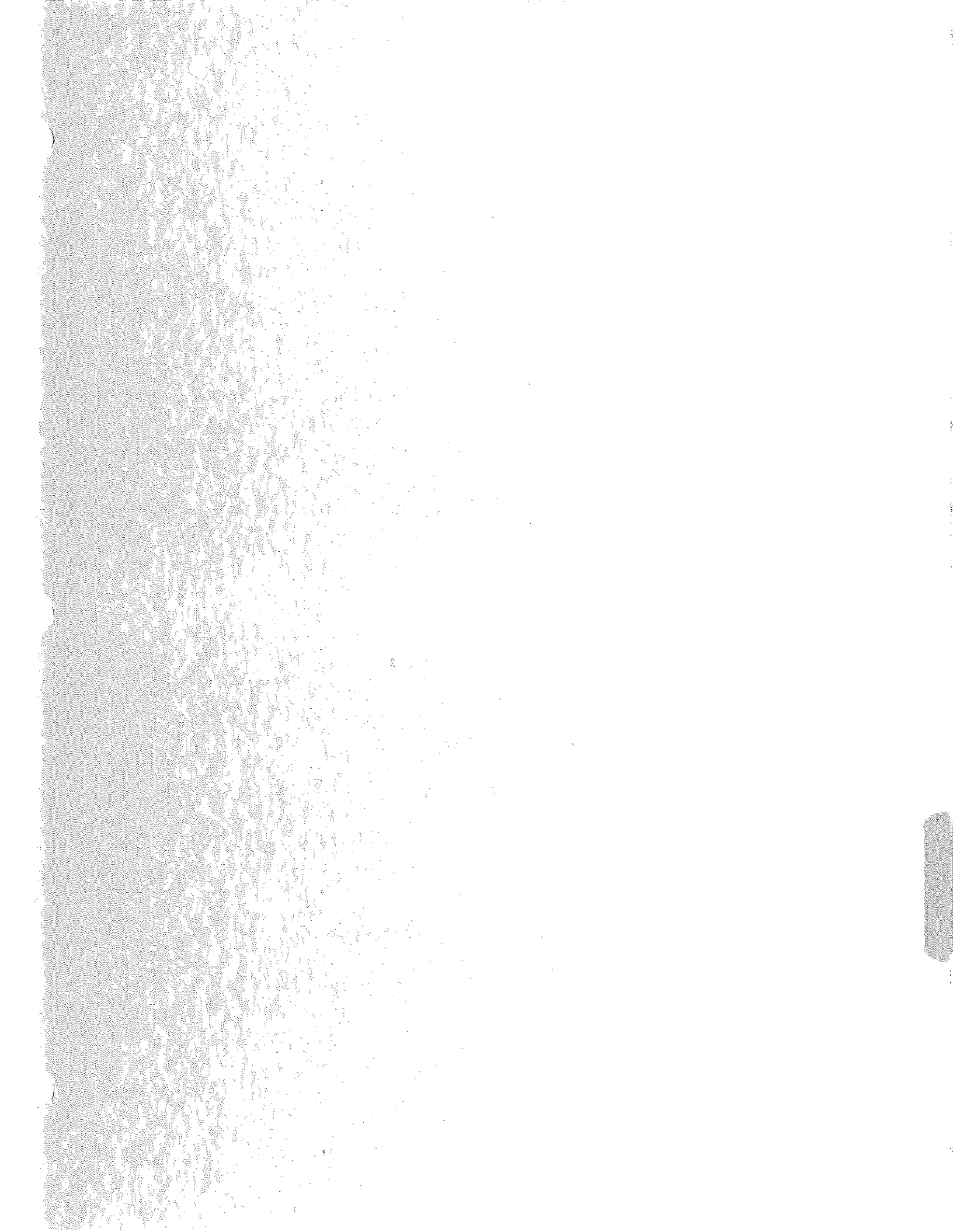

KARLHEINZ SCHREIBER

7 BITTERN COURT, ROCKCLIFFE PARK  
OTTAWA, CANADA K 1 L 8 K 9

TELEPHONE 613 748 7330  
TELEFAX 613 748 9697  
schreiberbarbel@aol.com

Personal

Per Fax [1] 514 369 9393

The Right Hon. Brian Mulroney, P.C., LL .D.  
47 Forden Crescent

Westmount, Quebec  
H3Y 2Y5

Ottawa, May 16, 2007

Dear Brian,

my purpose in writing to you is as follows.

Please ask The Honourable Robert Nicholson, your friend for many years, to stop the conspiracy between the IAG and the officials in Augsburg with respect to my case.

Please instruct the IAG and its lawyers to return fundamental justice and fairness to the Department of Justice and instruct the lawyers to consent to my bail.

I will look at the result as being the evidence regarding your cooperation and capability.

Please see attached the decision from Justice Lang for your information.

Yours truly,

Karlheinz

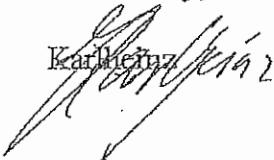



**CITATION: Schreiber v. Germany (Federal Republic), 2007 ONCA 80**  
**DATE: 20070208**  
**DOCKET: C46387/M34701/M34703**

**COURT OF APPEAL FOR ONTARIO**

**RE: KARLHEINZ SCHREIBER (Applicant) – and – THE FEDERAL  
REPUBLIC OF GERMANY and THE MINISTER OF JUSTICE and  
ATTORNEY GENERAL OF CANADA (Respondents)**

**AND RE: THE MINISTER OF JUSTICE (Applicant/Respondent) – and –  
KARLHEINZ SCHREIBER (Respondent/Applicant)**

**BEFORE: LANG J.A. (In Chambers)**

**COUNSEL: Edward L. Greenspan Q.C. and Vanessa Christie  
for the applicant/respondent Karlheinz Schreiber**  
**Moiz Rahman  
for the respondent/applicant, Attorney General of Canada**

**HEARD: February 7, 2007**

**On a motion for release pursuant to s. 20(c) of the *Extradition Act* pending the determination of the judicial review of the decision of the Minister of Justice dated December 14, 2006, and on a motion to expedite the judicial review of the decision of the Minister of Justice dated December 14, 2006.**

**ENDORSEMENT**

[1] Mr. Schreiber (the applicant) applies for bail pending determination of his judicial review application. That application is opposed by the Crown (the respondent), which seeks an order expediting the judicial review.

[2] The Crown concedes that it has no concern that the applicant will either flee or re-offend if released. Indeed, the applicant has complied with all terms during the many years he has been on release. However, the Crown opposes Mr. Schreiber's current application on the basis that the judicial review is frivolous. In the alternative, the Crown argues that, even if not frivolous, the merits of the judicial review are so weak that, when combined with the delay caused by seven and a half years of extradition hearings, judicial reviews and appeals, it is in the public interest to detain the applicant.

[3] This judicial review, the second in these extradition proceedings, is based on comments reported in the German press attributed to the chief prosecutor and the judicial spokesperson for the regional court in Augsburg, Germany. Those comments were reported in March 2006 in the days following this court's dismissal of the applicant's first judicial review and appeal.

[4] In those reports, the chief prosecutor is reported as having given his opinion that the

applicant would “definitely be imprisoned on remand” in Germany . In addition, the court spokesperson, a judge, is reported as having referred to the applicant as “the trigger of the entire affair and has caused damage to Germany ”.

[5] On the basis of those comments and others, the applicant sought a reconsideration of the Minister of Justice’s earlier surrender order, arguing that the comments reflected a prejudgment of the bail hearing and an abuse of process of sufficient gravity to violate the fundamental principles of justice.

[6] On December 14, 2006, the Minister refused to reconsider his surrender decision. In doing so, he distinguished this case from *United States of America v. Cobb* (2001), 152 C.C.C. (3d) 270 (S.C.C.) on the facts. He also noted that neither the chief prosecutor nor the judicial spokesperson was assigned to the applicant’s trial in Germany and, as well, that the fact of different processes in the extradition partner’s justice system, such as a judicial spokesperson, “does not mean that they are fundamentally unfair”. It is the Minister’s refusal to reconsider his surrender decision that is the subject of the judicial review.

[7] I am unable to agree that the judicial review is frivolous because it does raise issues for consideration. However, in my view, the grounds for judicial review are far from strong.

[8] In relying on the public interest grounds, as I have said, the Crown is not concerned with the possibility that the applicant will commit further offences or interfere with the process of justice. Rather, the Crown’s concern rests with Canada ’s obligation to fulfill its international commitments and to enforce the surrender order. In this sense, the Crown emphasizes the public interest in enforcing the surrender order over the public interest in the reviewability of that order.

[9] In *Trinidad and Tobago (Republic) v. Raghoonanan* (2003), 173 C.C.C. (3d) 294 (Ont. C.A. ) Simmons J.A. noted, in the extradition context, that the public interest in having a committal order enforced “weighs less heavily” against the granting of bail than does the public interest in the immediate enforcement of a sentence following a criminal conviction. In response, the Crown argues that the enforcement interest should be given more weight in this case because this is not simply the enforcement of a committal order, but of both committal and surrender orders that have been upheld throughout the judicial process, to and including the Supreme Court of Canada.

[10] However, even in these circumstances, I am of the view that there continues to be an important distinction between judicial interim release following extradition orders and release following sentencing dispositions. In the case of conviction and sentence, the applicant has been convicted of an offence and the Crown is seeking to maintain the enforceability of the order for punishment. With a surrender order, the applicant has not been found guilty of any crime; he continues to be presumed innocent.

[11] The Crown understandably raises the concern many would have that these proceedings have continued for seven a half years, at what this court has described as a “snail’s pace”. However, the reason for this delay is rooted in our procedures for extradition. The Crown does not suggest that the applicant has caused delay by his conduct of these proceedings.

[12] In my view, the public interest does not lie in imprisoning Mr. Schreiber simply out of frustration about the years these extradition proceedings have endured. Moreover, in this case, imprisoning the applicant will not serve the purpose sought by the Crown of enforcing the extradition, but in the absence of any other relevant concerns, will only serve to punish the applicant for availing himself of the very procedural avenues provided by Parliament. Accordingly, while the delay in this case is both frustrating and inordinate, it cannot be relevant.

[13] In saying this, I recognize the public interest that Canada fulfills its international obligations promptly. However, this new judicial review is based on statements allegedly made by the German prosecutor and spokesperson following the release of this court's decision. Accordingly, there are new grounds for this judicial review. It is not simply a thinly-veiled attempt to relitigate earlier dispositions. Thus, I would grant the application for bail.

[14] However, as the Crown submits, this case does cry out for an expeditious disposition because Germany has suffered prejudice.

[15] Mr. Greenspan argues against the Crown's expedition motion for two reasons. First, he wishes to undertake further investigation on the applicant's behalf, including obtaining an affidavit about the role of the court spokesperson in the German justice system. Second, Mr. Greenspan is committed to a lengthy trial in Chicago from March until June.

[16] Regarding the first point, any further investigation needed for the applicant's case can be completed with dispatch. In saying this, I note that the German press reports date back to March 2006 and the applicant has had the Minister's refusal to reconsider his surrender order since December 14, 2006. On the second point, Mr. Greenspan's Chicago commitment leaves him available on Fridays, absent any untoward scheduling problems with that case.

[17] It seems to me that the factors at issue are balanced fairly if the appeal is expedited for hearing to May 4, 2007. The applicant shall perfect his judicial review by March 23 and the respondent shall deliver its materials by April 13. The appellant will be allowed fifty minutes for argument and the respondent thirty minutes.

[18] In the result, since I am persuaded that the applicant has demonstrated that his continued detention is not necessary in the public interest, I release the applicant pending the judicial review hearing on the agreed-upon terms that have been filed with the court. As well, I am persuaded that this matter should be expedited and set May 4, 2007 as the hearing date for the judicial review application.

"S.E. Lang J.A."